



TIX  
HANDHELD



Getting Started

## Copyright and Trademark

© 2005 Palm, Inc. All rights reserved.

Palm, Addit, Blazer, Graffiti, HotSync, Palm Powered, Palm OS, the Palm logo, and VersaMail are among the trademarks or registered trademarks owned by or licensed to Palm, Inc. All other brand and product names are or may be trademarks of, and are used to identify products or services of, their respective owners.

Wi-Fi is a registered certification mark of the Wi-Fi Alliance. This product contains ACCESS Co., Ltd.'s NetFront 3.0 Internet browser software. Copyright © 1996-2003 ACCESS Co., Ltd. and ACCESS Systems America, Inc. NetFront is the trademark or registered trademark of ACCESS Co., Ltd. in Japan and in other countries except the United States of America. NetFront is a registered trademark of NetFront Communications, Inc. in the United States of America and is used under a license. A portion of this software includes software modules developed by the Independent JPEG Group. RealNetworks is the owner of all right, title, and interest in the RealNetworks Marks and RealNetworks logos. No person or entity may reproduce or use (or authorize the reproduction or use of) the RealNetworks Marks or RealNetworks logos in any manner other than expressly authorized by RealNetworks. Unauthorized use of RealNetworks Marks or RealNetworks logos is strictly prohibited.

## Disclaimer and Limitation of Liability

Palm, Inc. assumes no responsibility for any damage or loss resulting from the use of this guide.

Palm, Inc. assumes no responsibility for any loss or claims by third parties which may arise through the use of this software. Palm, Inc. assumes no responsibility for any damage or loss caused by deletion of data as a result of malfunction, dead battery, or repairs. Be sure to make backup copies of all important data on other media to protect against data loss.

**[ ! ] IMPORTANT** Please read the End User Software License Agreement with this product before using the accompanying software program(s). Using any part of the software indicates that you accept the terms of the End User Software License Agreement.

PN: 406-10454-00

# Table of Contents

<b>About This Guide</b> .....	<b>vii</b>
Tips for viewing this guide.....	vii
What's in this guide? .....	viii
<b>Chapter 1: Your Handheld</b> .....	<b>1</b>
What's on my handheld? .....	2
What software do I have?.....	6
Using the status bar.....	12
Rotating the screen .....	13
Opening applications.....	14
Using the 5-way navigator .....	16
Entering information on your handheld .....	18
Entering information using desktop software .....	20
Using menus .....	23
Learn more .....	24
Do's and don'ts .....	25
Beyond the basics.....	28
<b>Chapter 2: Moving Info Between Your Handheld and Your Computer</b> .....	<b>29</b>
Why synchronize information?.....	30
What information is synchronized?.....	31
How to synchronize .....	32
Installing applications to your handheld .....	33
Beyond the basics.....	35
<b>Chapter 3: Your Photo and Video Organizer</b> .....	<b>36</b>
Copying photos and videos .....	37
Viewing photos and videos .....	38
Organizing photos and videos into albums.....	41

Sending a photo or video using Bluetooth® wireless technology.....	44
Beyond the basics.....	45
<b>Chapter 4: Your MP3 Player .....</b>	<b>46</b>
Using Rhapsody as your desktop music application.....	47
Setting up Rhapsody for MP3.....	48
Transferring MP3 files to your handheld.....	50
Transferring music from a CD to your handheld.....	54
Playing music on your handheld.....	56
Beyond the basics.....	57
<b>Chapter 5: Your Microsoft Office File Manager .....</b>	<b>58</b>
Creating and managing Office files.....	59
Opening files from within Documents.....	60
Beyond the basics.....	61
<b>Chapter 6: Your Personal Information Organizer .....</b>	<b>62</b>
Organizing your personal information.....	63
Managing your contacts.....	64
Managing your calendar.....	68
Managing your tasks.....	72
Beyond the basics.....	75
<b>Chapter 7: Your Memos and Notes .....</b>	<b>76</b>
Organizing your memos and notes.....	77
Managing your memos.....	78
Managing your notes.....	80
Beyond the basics.....	82
<b>Chapter 8: Your Wireless Connections .....</b>	<b>83</b>
What can I do with built-in wireless technology?.....	84
When would I use Wi-Fi or Bluetooth technology?.....	84
Setting up a Wi-Fi network connection.....	86
Accessing email and the web using Wi-Fi® functionality.....	91

Entering basic Bluetooth® settings.....	93
Setting up a Bluetooth® phone connection .....	94
Accessing email and the web with Bluetooth® wireless technology .....	97
Setting up a connection for Bluetooth synchronization .....	99
Beyond the basics.....	103
<b>Chapter 9: Your Email.....</b>	<b>104</b>
Setting up an account.....	105
Getting and reading email .....	112
Sending an email message.....	113
Working with attachments .....	114
Working with Microsoft Exchange ActiveSync .....	118
Beyond the basics.....	119
<b>Chapter 10: Your Text Messaging Tool.....</b>	<b>120</b>
Sending a text message .....	121
Viewing a text message .....	122
Beyond the basics.....	123
<b>Chapter 11: Your Web Browser .....</b>	<b>124</b>
Accessing a web page.....	125
Beyond the basics.....	126
<b>Chapter 12: Your Expandable Storage .....</b>	<b>127</b>
What type of expansion cards can I use? .....	128
How can expansion cards help me?.....	128
Removing an expansion card .....	129
Inserting an expansion card.....	130
Beyond the basics.....	131
<b>Chapter 13: Your Personal Settings .....</b>	<b>132</b>
Changing entries in Favorites .....	133
Preventing your handheld from turning on by accident .....	134
Conserving battery power.....	135



Setting the date and time.....	137
Changing the screen fonts .....	139
Changing the background of your screen .....	141
Correcting problems with tapping .....	142
Selecting sound settings .....	143
Beyond the basics.....	144
<b>Chapter 14: Common Questions .....</b>	<b>145</b>
Beyond the basics.....	150
<b>Product Regulatory Information .....</b>	<b>151</b>
<b>Index .....</b>	<b>157</b>

# About This Guide





## [ ! ] **Before You Begin**

Complete the steps in *Read This First* in your handheld package to set up your handheld and install the software on your computer and your handheld.

This guide tells you everything you need to know to start using your handheld—from the things you’ll do every day, to the things that make your handheld not only useful, but fun.

## Tips for viewing this guide

Here are some helpful tips for making it easier to read and find information in this guide as you view it in Adobe® Reader®:





- To magnify the page, click the magnifying glass , move the cursor (which is now a magnifying glass) over the page, and click repeatedly. Click Previous View (  or  depending on your version of Reader) to return to the original view.
- Click an entry in the Table of Contents or Index to go directly to that section of the guide.
- If you click a link and go to a page in the guide, to return to the page you were on before you clicked the link, click Previous View (  or  depending on your version of Reader).
- When selecting the page(s) to print, be sure to use the file page number shown at the bottom of your computer screen, not the printed page number. For example, to print the first page of the Your Handheld chapter, select page 10 (the file page), not page 1 (the printed page).

## What's in this guide?

The info in this guide includes step-by-step instructions, links to cross-references, and sidebars.

### Step-by-step instructions

Here you'll find how-to information. Look for these cues in instructions:

 <b>Continued</b>	Cue that means the procedure continues on the next page.
 <b>Done</b>	Cue that signals the end of the procedure. You're done.
 <b>IMPORTANT</b>	A step that you must follow; otherwise, you could experience an error or even lose information.
 <b>OPTIONAL</b>	A step you might find useful.
 <b>NOTE</b>	Information that applies only in certain cases or that tells more about a procedure step.
<b>WINDOWS ONLY</b>	A procedure or text that applies to one platform only. In most cases, if you see one heading, check the following or preceding sections for the other. Sometimes there is no Mac counterpart for a Windows procedure or text; this feature is not available to Mac users.
<b>MAC ONLY</b>	

### Links

Links appear as underlined words throughout this guide. Links in body text or sidebars take you to other sections of this guide or to the *User Guide* on the web. The **In this chapter** list on the first page of each chapter contains links that send you to a specific section.



### \* Tip

To access the *User Guide*, you need to be connected to the Internet.

## Sidebars

### [ ! ] Before You Begin

Things you must complete before you can do the steps described in a procedure or group of procedures.

### \* Tip

A suggestion on how to use a feature more fully; a shortcut; a pointer to a related feature.

### + Did You Know?

An interesting fact about the topic being described; may include a link to more information.

### >> Key Term

A technical term related to the topic being described. The term may appear in this guide or only on your handheld.

### User Guide

A pointer to the *User Guide* on the web where you can learn about more things you can do with an application or feature.

### Tips & Tricks

A pointer to a website where you can share info with other handheld users and learn the latest tips, tricks, and more.

### Support

A pointer to the web where you can find help if you experience problems with the features discussed in the chapter or with your handheld.

# Your Handheld

## In this chapter

[What's on my handheld?](#)

[What software do I have?](#)

[Using the status bar](#)

[Opening applications](#)

[Using the 5-way navigator](#)

[Entering information on your handheld](#)

[Entering information using desktop software](#)

[Using menus](#)

[Learn more](#)

[Do's and don'ts](#)

[Beyond the basics](#)

Like a good personal assistant, your handheld helps you keep track of your schedule, your business and personal contacts, your to-do list, even your Microsoft Office and multimedia files.

Stay productive by carrying more of your important files and documents. Get connected with wireless access to email, text messages, and the web. View digital photo and video albums and listen to your favorite music (expansion card, sold separately, required for Mac users to listen to music on their handheld.) And don't worry about losing your information—even if the battery drains completely, the information stays in your handheld's memory. Simply recharge to access it again.



## Benefits

- Carry more of your important information, and work with it on the go
- Save time and stay organized
- Travel light
- Never lose important information
- Stay in touch with wireless connectivity

**\* Tip**

The Favorites application offers multiple pages of favorites. Pressing Home once opens the first page of Favorites; use the buttons in the upper-right corner of the Favorites screen to go to the other pages.

## What's on my handheld?

### Front

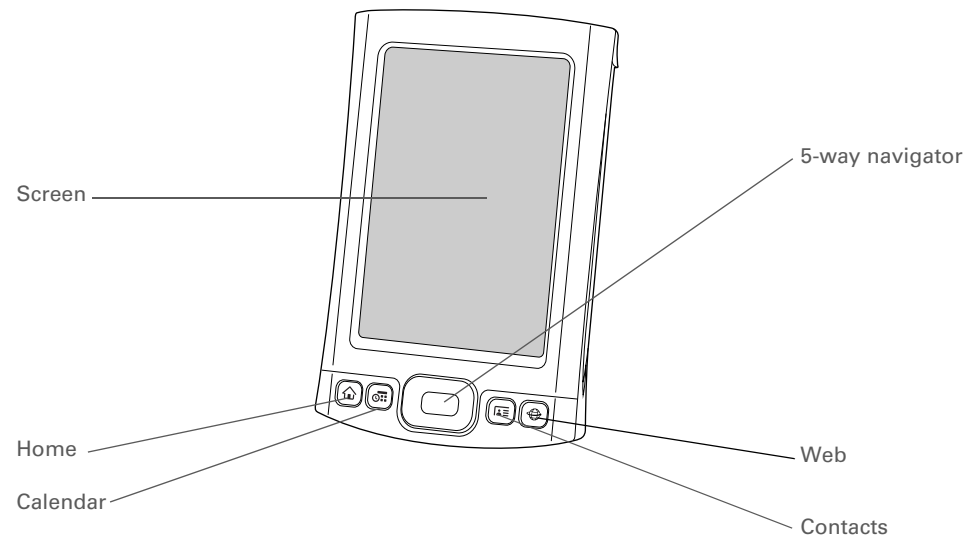

### Screen

Displays the applications and information on your handheld. The screen is touch-sensitive.

Display the input area by tapping the Input icon  on the **status bar**. Use the input area to enter info with **Graffiti® 2 writing** or the **onscreen keyboard**.

### Home quick button

Press once to open Favorites View, which lets you create a list of the items you want to quickly access. Favorites View can include applications and links to the web. Press twice to open Applications View, where you can see all of the applications on your handheld.

**Calendar quick button**

Press to turn on your handheld and jump to today's schedule.

**Contacts quick button**

Press to turn on your handheld and jump to your contacts list.

**Web quick button**

Press to turn on your handheld and jump to your home page in the web browser.

**5-way navigator**

Lets you move around and display info on the screen. Press Up, Down, Left, or Right to highlight different items, and press Center to select the highlighted item.

**+ Did You Know?**  
Beaming lets you quickly share appointments, addresses, phone numbers, files, photos, and more.

## Top

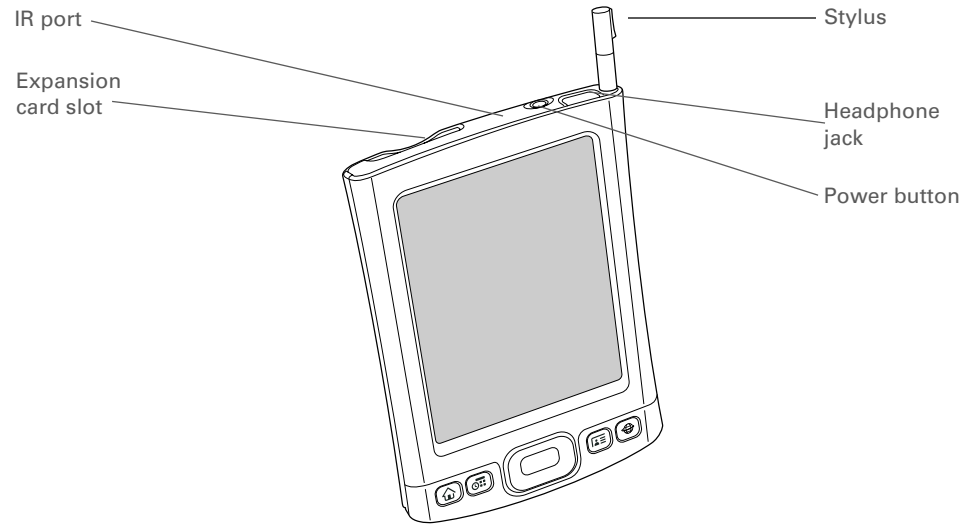

### Expansion card slot

Lets you insert an expansion card (sold separately) to back up info and add memory, applications, and accessories to your handheld.

### IR port

Short for *infrared port*. Beams information between handhelds and other devices that have an IR port. Beaming uses infrared technology to send information between two IR ports that are within a few feet of each other.

### Stylus

Lets you enter information on your handheld. To use the stylus, slide it out of the slot and hold it as you would a pen or pencil.

### Headphone jack

Lets you connect standard 3.5 mm headphones (sold separately) to your handheld so you can listen to music and other audio applications.

### Power button

Turns your handheld on or off and lets you turn **Keylock** on (if active). When Keylock is on, your handheld does not respond when you press the quick buttons or tap any icons.

## Back

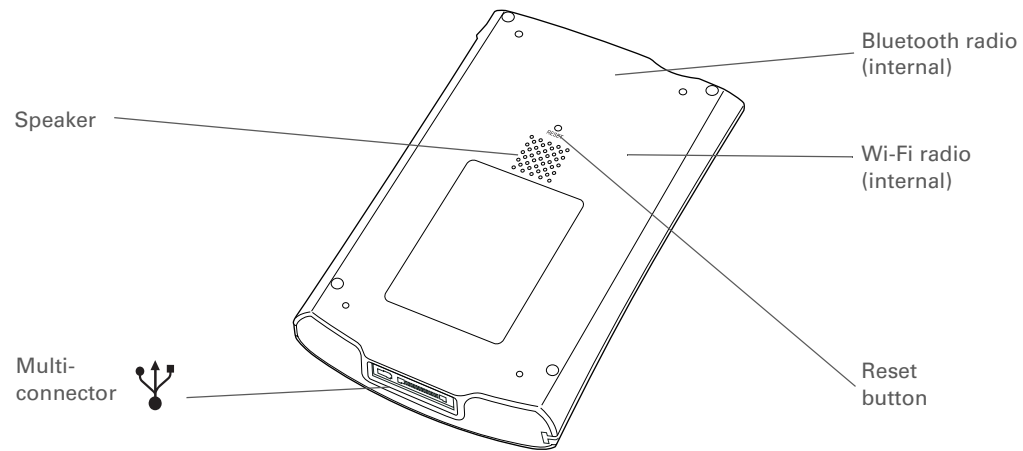

### Multi-connector

Lets you connect the sync cable (included) or a cradle (sold separately) to your computer or connect the AC charger to an electric outlet. Connect the sync cable when you want to synchronize, or exchange, information. Connect the AC charger to keep your handheld's battery charged.

### Speaker

Lets you listen to alarms, game and system sounds, and music.

### Bluetooth® radio (internal)

Enables your handheld to connect with other devices (sold separately) that use **Bluetooth wireless technology**, so you can dial phone numbers directly from Contacts, send and receive email and text messages, browse the web, and more.

### Wi-Fi® radio (internal)

Enables your handheld to connect to a **Wi-Fi network** to wirelessly access email, browse the web, and synchronize.

### Reset button

Resets your handheld if it freezes (stops responding). To do a soft reset, use the tip of the stylus to gently press the reset button inside the hole on the back panel of your handheld.

**\* Tip**

Check the [User Guide](#) on the web for complete instructions on how to use many of the applications included with your handheld.

## What software do I have?

Your handheld comes with many applications preinstalled and ready to use. In addition, the software installation CD that came with your handheld includes desktop software for your computer and additional software for your handheld. When you set up your handheld you can install some (or all) of these applications. You can install any of the applications at any time after you set up your handheld, as well.

### Personal information

These applications let you organize your contacts, calendar events, and more, as well as keep information updated between your handheld and your computer. They are already installed on your handheld.

**Calendar**

Manage your schedule from single entries, like lunch with a friend, to repeating and extended events, like weekly meetings and holidays. Even color-code your schedule by category.

**Contacts**

Store names and addresses, phone numbers, email and website addresses—even add a birthday alarm or a contact's photo.

**Tasks**

Stay on top of your to-do list. Enter things you need to do, prioritize them, set alarms, and then monitor your deadlines.

**Memos**

Capture information such as meeting notes, lists of books to read, movies to see, recipes, and anything else you need to write down.

**Note Pad**

Write on the screen in your own handwriting or draw a quick sketch.

**Expense**

Track business or travel expenses and print expense reports after you synchronize your handheld with your computer.

**HotSync®**

Synchronize info on your handheld with the info on your computer.

**\* Tip**

Can't find an application on your handheld? First tap the Home icon in the **input area** and select All from the category pick list in the upper-right corner to view all applications on your handheld (except the wireless applications, Wi-Fi and Bluetooth, which you need to access from the status bar). If you don't see the application there, you may need to install it from the CD.

**Productivity**

These applications let you carry your office with you, so you can work with crucial information on the go. They may already be installed on your handheld, or you may need to install them from the CD.

**Documents**

View and edit Microsoft Word and Excel files, and create compatible files that you can save in Word or Excel format. View and manage PowerPoint files.

**Calculator**

Do basic math calculations such as splitting restaurant bills and figuring tips.



**Adobe® Reader® for Palm OS** View PDF-compatible files that are tailored to fit your handheld's screen.

**Multimedia and entertainment**

Here is the software that lets you relax and have fun. These applications may already be installed on your handheld, or you may need to install them from the CD.

**Media**

View and organize photos and videos.

**Pocket Tunes™**

Carry music, create playlists, and listen to music on your handheld. This application works with the Rhapsody desktop application that you can install from the CD (Windows only; download required for Rhapsody). Both Mac and Windows users can use Pocket Tunes on the handheld. (Expansion card, sold separately, required for Mac users to listen to music on their handheld.)

**Handmark Solitaire**

Enjoy hours of entertainment with this solitaire game.

**Power by Hand eReader**

Purchase and download eBooks from the web so you can read them when you want, where you want.

**AudiblePlayer**

Listen to newspapers, audio books, public radio, and more. (Windows only; download requires Internet connection; additional fees may apply.)



**\* Tip**

To install extra software from the CD, insert the CD into your CD drive, and then do one of the following:

**Windows** On the Discover your device screen, click Add software to your device.

**Mac** Double-click the Essential Software folder icon.

**Connectivity**

These applications let you stay connected by browsing the web, checking your email, and more. They may already be installed on your handheld, or you may need to install them from the CD.

**Wi-Fi controls**

Set up wireless connections to a Wi-Fi network for sending and receiving information. Access these controls from the **status bar**.

**Bluetooth controls**

Set up wireless connections to a mobile phone, network, or computer for sending and receiving information. Access these controls from the **status bar**.

**VersaMail®**

Send, receive, and manage email messages wirelessly using your handheld's wireless capabilities or by synchronizing with your Windows computer.

**Web**

Browse your favorite websites using your handheld's wireless capabilities.

**SMS**

Send and receive short text (SMS) messages using your handheld's wireless capabilities.

**WiFile™**

Access your wireless network so that you can download pictures, documents, and more that are located in shared folders on a networked computer.

**Dialer**

Dial phone numbers directly from your handheld.

- \* **Tip**  
After you install an application and discover how valuable it is, be sure to add it to Favorites.
- \* **Tip**  
Use the Enterprise Software link to check for new software available from the Palm enterprise website.

## Customization

These applications let you customize your handheld to make it uniquely yours. They may already be installed on your handheld, or you may need to install them from the CD.



### Favorites

Customize a list of your favorite applications and web pages so that you can locate and open them quickly.



### Prefs

Customize your handheld's sound levels, colors, security, and more.



### Addit™

Receive notifications of upgrades and patches and then install them onto your handheld; obtain personalized news and other information as well as user tips at a glance; preview, try, and buy software for your handheld. (Windows only for downloads using the sync cable; both Windows and Mac users can download software using your handheld's wireless capabilities. Internet connection required.)



### Handmark Express

Download current news as well as information on the weather, stocks, sports, movies, and more. (Download requires Internet connection and subscription to service with Handmark.)



### Enterprise Software link

Access the Palm enterprise website, where you can purchase corporate software such as a VPN client; software that provides robust security for Wi-Fi authentication and connection to a network; and Java Virtual Machine (JVM) software for running Java applications on your device. (Download requires Internet connection; additional fees may apply.)



### World Clock

Set the time in your home city and two other locations, and set an alarm to wake you up.



### Card Info

View information about an expansion card seated in the expansion card slot.

### + Did You Know?

During CD installation, you can choose to synchronize the info in Contacts, Calendar, Tasks, and Memos on your handheld with info in Contacts, Calendar, Tasks, and Notes in Microsoft Outlook on your computer (Windows only). Other applications are still synchronized with Palm Desktop software.

### » Key Term

**HotSync®** Technology that allows you to synchronize the information on your handheld with the information on your computer.

## Desktop

The desktop software lets you use your computer to create and manage info for applications on your handheld. Install this software from the CD.



### Palm® Desktop software

View, enter, manage, and back up info for Calendar, Contacts, Tasks, Media, Memos, and Expense on your computer. (Expense and Media are Windows only.) You can also view, manage, and back up info for Note Pad. When you synchronize your handheld with your computer, this info is updated in both places. Palm Desktop software is installed automatically during the initial CD installation process.

Palm Desktop includes HotSync® Manager software, which allows you to customize the settings for synchronization. You can access HotSync Manager by selecting its icon in the task bar at the bottom of your computer screen.

HotSync Manager



### Quick Install (Windows only)

Install applications and transfer files from your Windows computer to your handheld or to an expansion card (sold separately) that is seated in the expansion card slot. Quick Install is installed automatically during the initial CD installation process.



### Send To Handheld droplet (Mac only)

Install applications and transfer files from your Mac computer to your handheld or to an expansion card (sold separately) that is seated in the expansion card slot. The Send To Handheld droplet is installed automatically during the initial CD installation process.



### Documents To Go

Companion desktop software for the Documents application on your handheld. Lets you transfer Microsoft Word, Excel, and PowerPoint files to your handheld, as well as create and edit files.

**+ Did You Know?**

Some applications are automatically assigned to a category when you install them. Assign any application to a category in **Applications** by selecting **Category** in the App menu. Select the pick list next to the application's name, and then select a category.

**Rhapsody  
(Windows only)**

Transfer MP3 music files from your computer to your handheld or to an expansion card (sold separately), and copy music from your CDs to your computer. This is the desktop companion for the Pocket Tunes application on your handheld. (Download requires Internet connection.)

**Windows Media Player  
link/Direct X link  
(Windows only)**

Work with the Media desktop application. These applications are required for Media to prepare videos for playback on your handheld. (Download requires Internet connection.)

**NOTE** We recommend that you use the links to download the current versions of Windows Media Player and Direct X, even if you already have Windows Media Player on your computer. These versions contain all of the components needed to prepare videos for playback on your handheld.

**Pocket Tunes plug-in  
(Windows only)**

Works with Rhapsody to convert music files to a format that you can carry on your handheld so that you can play them using the Pocket Tunes application on your handheld. (Rhapsody download requires Internet connection.)

The plug-in installs automatically during the initial CD installation process. It is included on the CD in case you should ever need to manually re-install it.

\* **Tip**  
Use the Find dialog box to locate specific items of information on your handheld—for example, a name or a phone number.

+ **Did You Know?**  
The System info icon shows the current time on the status bar.

\* **Tip**  
The Wi-Fi controls signal-strength bars show an exclamation point (!) if Wi-Fi functionality is turned on but you are not connected to a network.

## Using the status bar

The status bar at the bottom of the handheld screen gives you access to valuable tools and is accessible in all views.

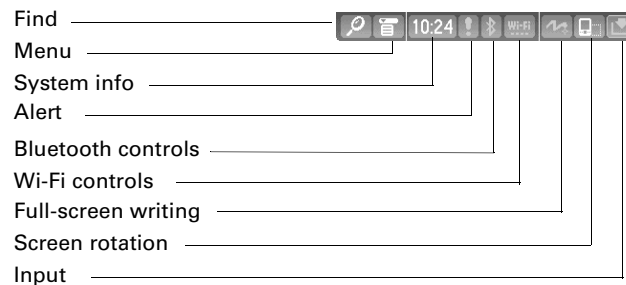

<b>Find</b>	Tap to open the <b>Find dialog box</b> .
<b>Menu</b>	Tap to <b>open the menus</b> for the current screen.
<b>System info</b>	Tap to open the system information dialog box. The dialog box shows the date and time, available memory, and battery level, and allows you to turn system sounds on and off and to adjust screen brightness.
<b>Alert</b>	Tap to display the <b>Reminders screen</b> .
<b>Bluetooth controls</b>	Tap to display the <b>Bluetooth</b> dialog box, where Bluetooth functionality can be turned on and off and you can connect to another Bluetooth device. The icon changes from gray to white when Bluetooth functionality is turned on.
<b>Wi-Fi controls</b>	Tap to display the <b>Wi-Fi</b> dialog box, where you can make a wireless connection to a Wi-Fi network. The icon displays “Wi-Fi” if Wi-Fi functionality is turned off and signal-strength bars if it is turned on.
<b>Full-screen writing</b>	Tap to turn <b>full-screen writing</b> on and off. When on, you can write Graffiti® 2 characters anywhere onscreen.
<b>Screen rotation</b>	Tap to switch between <b>landscape and portrait view</b> .
<b>Input</b>	Tap to switch between showing and hiding the <b>input area</b> . Tap and hold to display the input area selection menu.

- + **Did You Know?**  
You can customize which way the screen rotates in landscape mode by **choosing right- or left-handed rotation.**

## Rotating the screen

You can switch between landscape and portrait views by tapping Screen rotation  on the status bar. Landscape view is useful for viewing spreadsheets, email, web pages, and photos.

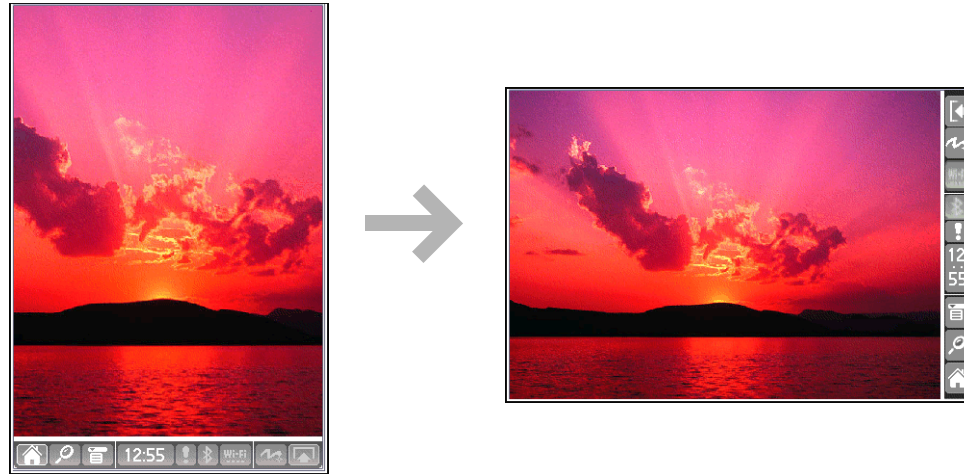

\* **Tip**  
Press Home once to open Favorites; press Home twice to open Applications. Switch between Favorites and Applications by pressing Home.

+ **Did You Know?**  
You can use a favorite photo as the background for Favorites or Applications View.

\* **Tip**  
Press and hold the Home button to see a list of recently used applications.

## Opening applications

Your handheld lets you display two views to quickly see and open the applications you use most. Favorites lets you create a list of the items you want to quickly access, while Applications lets you access all of the applications on your handheld—except the wireless applications, Wi-Fi and Bluetooth, which you need to access from the status bar.

### Using Favorites View

Favorites View can include applications and links to the web. Certain items are included in Favorites by default, but you can **customize the list** to contain any items you want.

To access an item from Favorites, press Home  and select an item from the list. Use the 5-way navigator or select the numbers in the upper-right corner of the screen to move to another page of favorites.

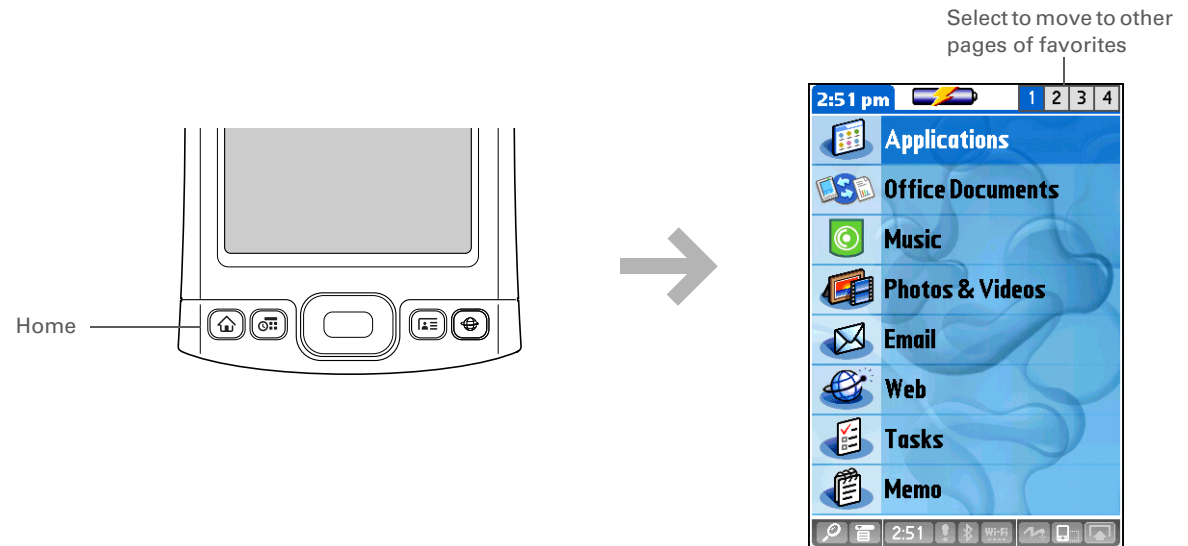

\* **Tip**  
You can open individual applications by pressing the **quick buttons** on the front of your handheld or tapping the icons in the **input area**. Note that tapping the Home icon is another way to access Applications View.

\* **Tip**  
Press Center on the 5-way to scroll through application categories.

## Using Applications View

The Applications View lets you access all of the applications on your handheld, except the wireless applications, Wi-Fi and Bluetooth, which you access from the **status bar** and are available on any screen. Use the category pick list in the upper-right corner of the screen to view applications by category or to view all applications.

To access an item from Applications, press Home  twice and select an icon.

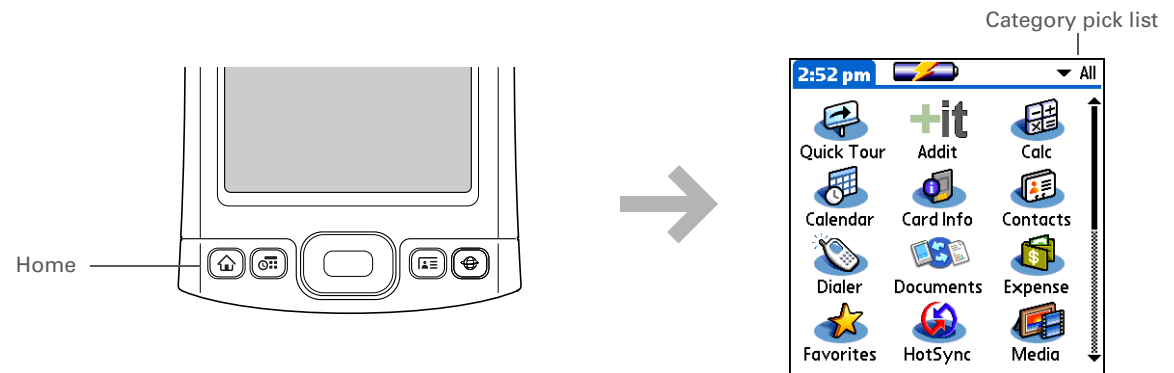



\* **Tip**  
See the [User Guide](#) on the web for complete details about using the 5-way on different types of screens.

\* **Tip**  
A few onscreen elements of your handheld can only be activated by tapping them with your stylus, for example, icons in the input area and on the status bar.

## Using the 5-way navigator

The 5-way navigator lets you access information quickly with one hand and without the stylus. The 5-way does various things based on which type of screen you're viewing, and which item on the screen is highlighted. To use the 5-way, press Up, Down, Left, Right, or Center.

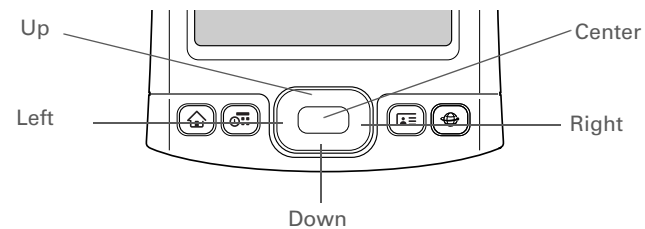

On most screens, one item—a button, a list entry, or an entire screen—is highlighted by default. The highlight identifies what element will be affected by your next action. Use the 5-way to move the highlight from one item to another onscreen.

\* **Tip**

When an entire screen is highlighted, only the top and bottom borders acquire the glow; the left and right borders do not show the highlight.

The highlight can take one of three forms, depending on what is highlighted:

**Border glow** This highlights elements of the user interface like command buttons, pick lists, and arrows.



**Reverse type (white text on a dark background)**

This highlights an entry on a list screen or a phone number, email address, or web link on a web page or in a message.

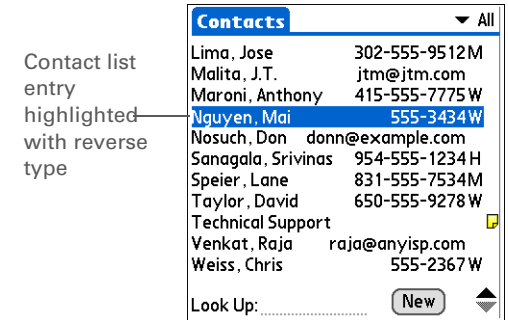

**Blinking cursor** The blinking cursor tells you that you can enter text at that point.

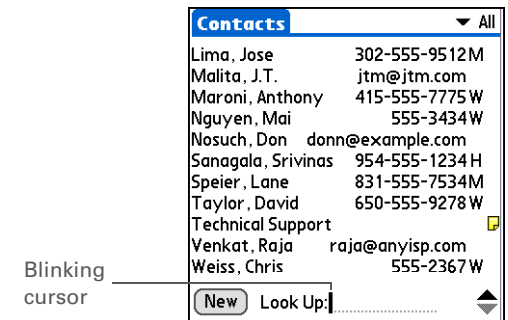

- \* **Tip**  
Write letters on the left side of the input area and numbers on the right. Uppercase letters go in the center.
- \* **Tip**  
Display the Graffiti 2 help screens at any time. Just draw a single stroke from the bottom of the input area to the top of your handheld's screen.

## Entering information on your handheld

There are several ways to enter information directly on your handheld. The most popular methods are using Graffiti 2 writing or using the onscreen keyboard from the **input area**. You can also **enter information directly on your computer** and transfer it to your handheld by **synchronizing**.

### Learning Graffiti® 2 writing

Graffiti 2 writing is a special set of letters, numbers, and symbols that you can use to write directly on the screen. With only a few minutes of practice, you can learn to use Graffiti 2 writing—and help is always only a tap away.

**1**

**Go to Applications** and select Quick Tour .

**2**

Select Writing Tips. Navigate through the screens to learn Graffiti 2 writing.

↓ Done

**» Key Term**

**Entry** A piece of information entered in an application such as a contact in Contacts or an appointment in Calendar.

**\* Tip**

You can enter text whenever you see a blinking cursor on the screen.

## Using the onscreen keyboard

You can use the onscreen keyboard in any application where you need to enter text, numbers, or symbols on your handheld.

**1**

Open an entry:

- a. **Open an application.**
- b. Select an entry or tap New.

**2**

If the input area is hidden, select Input  on the status bar to open it.

**3**

Tap abc or 123 to open the alphabetic or numeric keyboard, respectively.

↘ **Continued**



Tap to open keyboards

**\* Tip**

If you have a lot of information to enter, a portable wireless keyboard accessory makes data entry fast and easy. Visit [www.palm.com/myTX](http://www.palm.com/myTX) and click the Accessories link.

**4**

**[ & ] OPTIONAL** Select from among four separate keyboards.

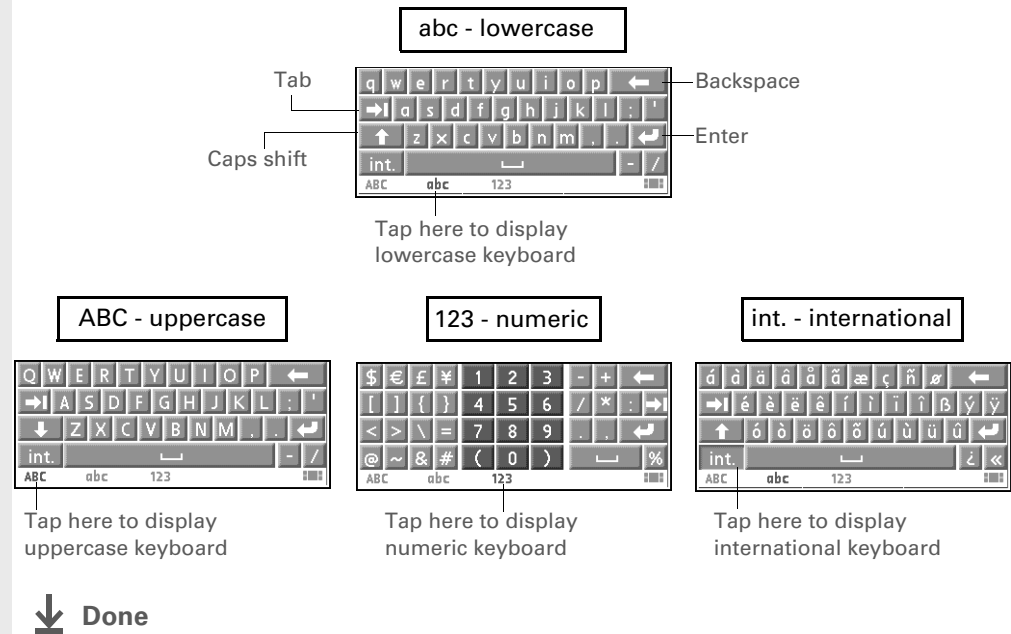

## Entering information using desktop software

Use Palm Desktop or Microsoft Outlook (Windows only) to enter information on your computer in applications such as Calendar, Contacts, Tasks, and Memos. The info is transferred to the corresponding handheld application when you synchronize. Information entered in these applications on the handheld is likewise synchronized with the application in the desktop software.

- \* **Tip**  
 The Palm Desktop online Help has lots of info about how to use Palm Desktop software. Open the Help menu and select Palm Desktop Help.

### WINDOWS ONLY

Double-click the Palm Desktop icon on your computer desktop, and then click the icons in the launch bar to access the various applications.



Launch bar

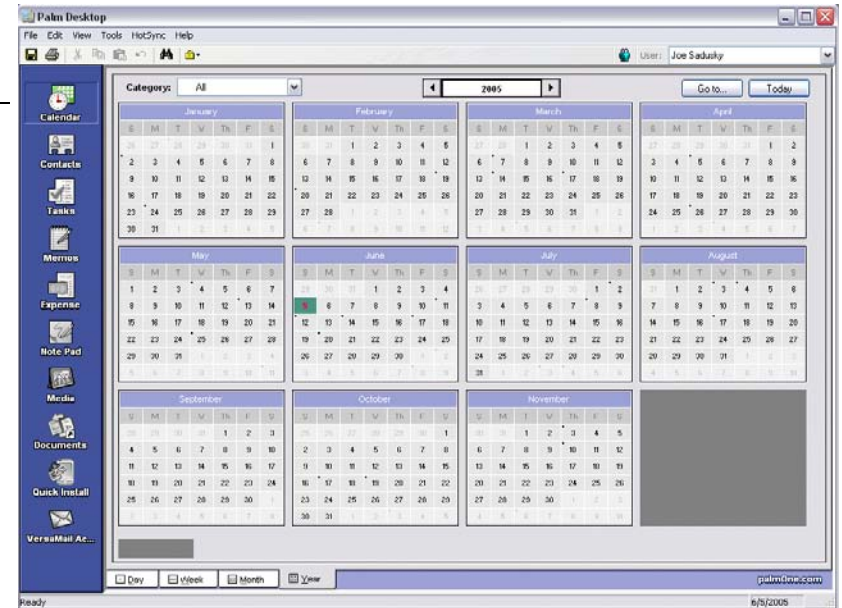

**MAC ONLY**

Double-click the Palm Desktop icon in the Palm folder on your computer, and then click the icons in the launch bar to access the various applications.

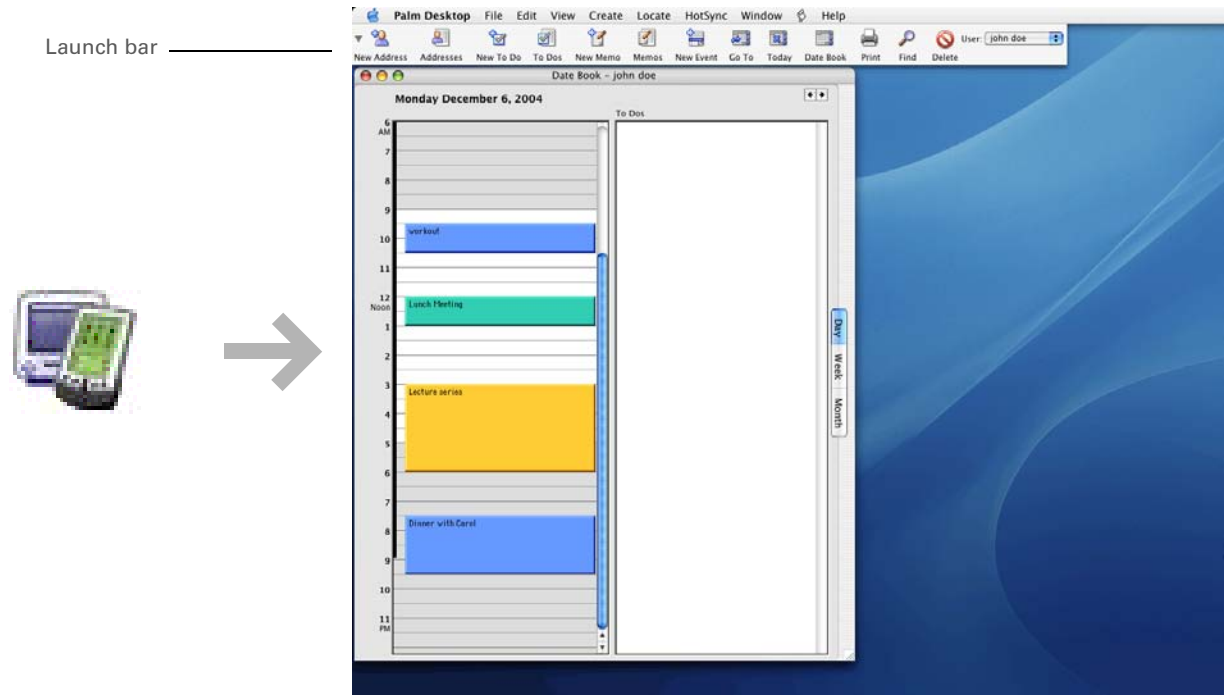

\* **Tip**  
You can also open the menus by tapping the application name in the upper-left corner of the screen.

\* **Tip**  
When the menus are open, you can **use the 5-way navigator** to select menus and menu items.

## Using menus

Menus let you access additional commands and settings. They are easy to use, and once you master them in one application, you know how to use them in all your applications.

<b>1</b>	<b><u>Open an application.</u></b>
<b>2</b>	Tap Menu  on the status bar.
<b>3</b>	Select a menu, and then select a menu item.  ↓ Done





**\* Tip**

If you're a Windows user, you can access the T|X Handheld Help from the Start menu. Navigate to Programs, navigate to the Palm program group, and then select Palm T|X Help. Windows users can also download the *Getting Started* PDF from [www.palm.com/support](http://www.palm.com/support).

## Learn more

The following tools are available to help you learn how to use your handheld and many of the applications on it.

- User Guide** For everything you need to know about your handheld—all that's in this guide, and much more—go to [www.palm.com/TX-userguide](http://www.palm.com/TX-userguide).
- Tutorial** Learn to use the popular features of your handheld. The Tutorial includes a tour of your handheld and step-by-step instructions. Access it from the CD.
-  **Quick Tour** Learn about your handheld and how to enter information. Select the Quick Tour icon in Applications View.
- Tips & Tricks** Make your handheld uniquely yours. For great tips, software, accessories, and more, visit [www.palm.com/myTX](http://www.palm.com/myTX).
- Support** If you're having problems with anything on your handheld, go to [www.palm.com/support](http://www.palm.com/support).
-  **Manual** Install a version of the information you're reading on your handheld. Install it from the software installation CD.

On a Windows computer, this is the T|X Handheld Help. On a Mac computer, it is the Acrobat (PDF) file called *Getting Started*.

**NOTE** The Windows and Mac information is identical; it is just presented in different formats.

## Do's and don'ts

To protect your handheld from damage and ensure reliable performance, follow these guidelines.

### Do's

- Use only the stylus to tap the screen—no pens, pencils, paper clips, or other sharp objects.
- Use only the supplied AC charger to charge your handheld.
- **Keep the battery charged.**
- Keep the screen free of dust (or anything else that could make it dirty).
- For general cleaning, use a soft, damp cloth. If the screen becomes dirty, use a soft cloth moistened with a diluted window-cleaning solution.
- Use only 3.5mm stereo headphones (sold separately) in your handheld's headphone jack.
- Be sure to **get rid of any static electricity buildup** before you connect your handheld to any cable or accessory.
- **Synchronize** often to maintain a backup copy of your important information on your computer.

## Don'ts

**[ ! ] IMPORTANT** Do not open your handheld for any reason. There are no user-serviceable parts inside.

- Do not drop, bang, or otherwise cause a strong impact to your handheld.
- Do not carry your handheld in your back pocket; you might sit on it by mistake.
- Do not let your handheld get wet; don't leave it in a damp location.
- Do not expose your handheld to very hot or cold temperatures, including placing it near a heater, leaving it in the trunk of a car, or setting it by a window in direct sunlight.
- Do not carry or use your handheld at extremely high altitudes, unless you're in an airplane.

**\* Tip**

Be sure to charge your handheld for a full three hours if it does not turn on when you press the power button.

**Conserving battery power**

If you see an alert on the screen warning you that the battery is low, recharge your handheld. Also recharge your handheld if it doesn't turn on when you press the power button.

**NOTE** The memory on your handheld is designed to store your information even if the battery becomes drained to the point that you cannot turn on your handheld. When you recharge your handheld, all of your existing information reappears.

Conserve battery life by doing any of the following:

- **Adjust the screen brightness**
- **Reduce the Auto-off setting**
- **Use Keylock to prevent your handheld from turning on by accident**
- Stop **music** or **video** playback when not in use
- **Respond to or cancel alerts** promptly
- **Turn off Bluetooth wireless technology and Wi-Fi functionality** when not in use
- **Minimize use of the expansion slot**

**User Guide**

For everything you need to know about your handheld—all that's in this guide, and much more—go to [www.palm.com/TX-userguide](http://www.palm.com/TX-userguide).

**Tips & Tricks**

Make your handheld uniquely yours. For great tips, software, accessories, and more, visit [www.palm.com/myTX](http://www.palm.com/myTX).

**Support**

If you're having problems with your handheld, go to [www.palm.com/support](http://www.palm.com/support).

## Beyond the basics

Click the link to the *User Guide* on the web and learn about these related topics:

**Entering Information**

Entering information with Graffiti 2 characters

**Moving Around**

- Working with Favorites and Applications
- Finding information on your handheld

**Moving Info**

- Adding applications to your handheld
- Deleting applications from your handheld
- Viewing application information

**Categories**

Organizing your applications and information by filing them into categories

**Privacy**

Keeping information private by turning on security options

**Sharing**

- Beaming information and applications to other Palm Powered™ devices
- Sending information and applications to other Bluetooth devices by using Bluetooth technology on your handheld

**Maintaining**

Caring for your handheld

# Moving Info Between Your Handheld and Your Computer

## In this chapter

[Why synchronize information?](#)

[What information is synchronized?](#)

[How to synchronize](#)

[Installing applications to your handheld](#)

[Beyond the basics](#)

If you regularly synchronize your handheld with your computer, you know what a powerful tool synchronization is for transferring, updating, and backing up large amounts of information on your handheld.

Synchronizing simply means that information that has been entered or updated in one place (your handheld or your computer) is automatically updated in the other. There's no need to enter information twice.



## Benefits

- Quickly enter and update information on your computer and your handheld
- Install applications
- Protect your information
- Send photos and videos to your handheld from your desktop computer

\* **Tip**  
Synchronize Microsoft Word, PowerPoint, or Excel files from your computer and open them in the **Documents** application on your handheld to view and edit them at your convenience.

## Why synchronize information?

**Quickly enter and update information.** Synchronizing updates and exchanges information between your handheld and **Palm® Desktop software** on your computer. For example, you can quickly enter a contact list on your computer and then send it to your handheld—no re-entering necessary!

**NOTE** During CD installation, you can choose to **synchronize your handheld with Microsoft Outlook** on your computer (Windows only).

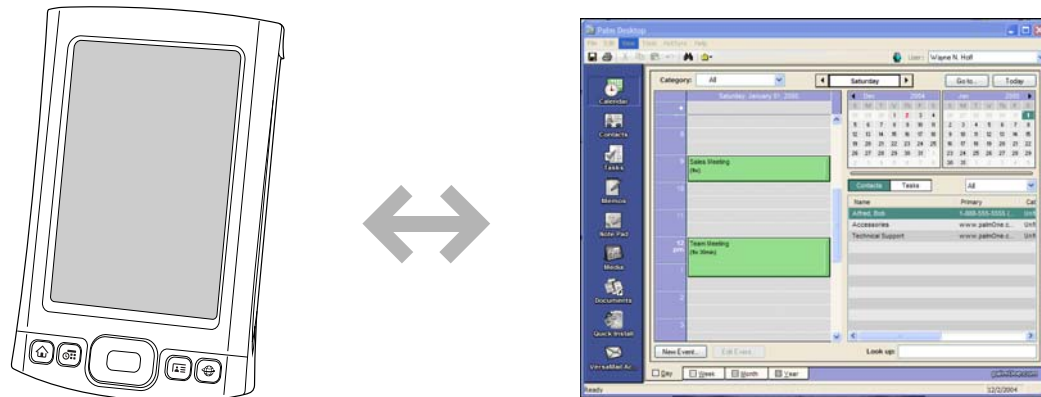

**Install applications.** With just a few clicks, you can use **Quick Install** (Windows) or the **Send To Handheld droplet** (Mac) to install applications on your handheld or to copy certain types of files to your handheld.

**Protect your information.** Nothing is worse than losing important information. When you synchronize information, you create a backup copy. If something happens to your handheld or your computer, the information is not lost; one tap restores it in both places.

**[ ! ] IMPORTANT** Be sure to synchronize information frequently so that you always have an up-to-date backup copy of important information.

**[ ! ] Before You Begin**

Complete the following:

- Perform initial handheld setup.
- Install Palm Desktop software and additional software from the CD.

For setup and installation procedures, see *Read This First* included in your handheld package.

**» Key Term**

**Conduit** The synchronization software that links an application on your computer with the same application on your handheld.

**\* Tip**

You can synchronize your handheld with your computer wirelessly using the built-in Wi-Fi® or Bluetooth® technology on your handheld.

## What information is synchronized?

When you install Palm Desktop software from the software installation CD, a conduit is installed to your computer for each of the following applications. The conduits allow you to transfer information between the application on your handheld and the corresponding application in Palm Desktop software when you synchronize:



**NOTE** Information from Expense and Media is synchronized on Windows computers only.

During CD installation, you can choose to synchronize your handheld with Microsoft Outlook on your computer (Windows only). If you do, info from Contacts, Calendar, Tasks, and Memos is synchronized with info in the same application in Outlook (Memos is called Notes in Outlook). Information for Expense, Note Pad, and Media is still synchronized with the same application in Palm Desktop software. You can insert the CD at any time to choose synchronization with Outlook if you did not do so during the initial installation.

**NOTE** You can also set up the VersaMail® application to synchronize with Outlook.

You can synchronize more than one handheld with your computer. For example, family members can all synchronize their handhelds with the same copy of Palm Desktop software. Just make sure that each handheld has its own username; the desktop software reads the username and recognizes the handheld during synchronization. Loss of info may occur from sharing the same username.



\* **Tip**  
If the Select User dialog box appears during synchronization, select the username whose information you want to synchronize, and then click OK.

\* **Tip**  
If you need help with synchronizing, see [What do I do if I can't synchronize with my computer?](#)

## How to synchronize

**1**

Connect the USB sync cable to the USB port on the back of your computer, and then insert the other end into your handheld.

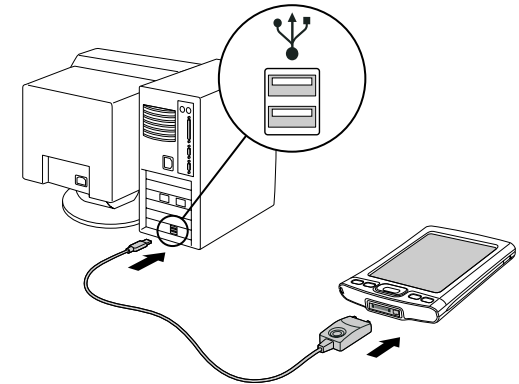
**2**

Synchronize your handheld with your computer:

- a. Press the sync button on the USB sync cable.
- b. When synchronization is complete, a message appears at the top of your handheld screen, and you can disconnect your handheld from the connector.

↓ Done

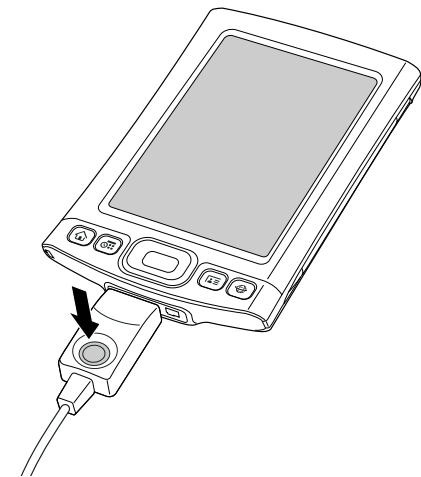

**\* Tip**

A confirmation dialog box shows whether the items will be copied to your handheld or to an expansion card. Choose which handheld will receive the items by selecting the username from the User drop-down list in the upper-right corner.

**+ Did You Know?**

You can move multiple applications into the Quick Install window to have them ready for installation the next time you synchronize.

## Installing applications to your handheld

Use Quick Install (Windows) or the Send To Handheld droplet (Mac) to install applications on your handheld.

### Using Quick Install

#### WINDOWS ONLY

**1**

Click the Quick Install icon on your desktop.

**2**

Copy the application:

- a. Drag and drop the application onto the Quick Install window.
- b. When the confirmation dialog box appears, confirm your username, the application name, and the destination, and then click OK.

**3**

**Synchronize to install the application on your handheld.**

↓ Done

\* **Tip**  
Also use the Send To Handheld droplet to copy photos, videos, and music files from your Mac computer to your handheld.

\* **Tip**  
In Mac OS X, you can make the Send To Handheld droplet a permanent part of your desktop by dragging the droplet to the Dock. Then simply drag photos, and other files you want to transfer to your handheld, onto the Dock.

## Using the Send To Handheld droplet

### MAC ONLY

**1**

Select the application you want to install:

- a. Drag and drop the application onto the Send To Handheld droplet in the Palm folder.
- b. In the Send To Handheld dialog box, select your username and click OK.

**2**

**Synchronize to install the application on your handheld.**

↓ Done

**User Guide**

For everything you need to know about your handheld—all that's in this guide, and much more—go to [www.palm.com/TX-userguide](http://www.palm.com/TX-userguide).

**Tips & Tricks**

Make your handheld uniquely yours. For great tips, software, accessories, and more, visit [www.palm.com/myTX](http://www.palm.com/myTX).

**Support**

If you're having problems with synchronization or with anything else on your handheld, go to [www.palm.com/support](http://www.palm.com/support).

## Beyond the basics

Click the link to the *User Guide* on the web and learn about these related topics:

**Moving Info**

- Synchronizing your handheld with Microsoft Outlook on your computer
- Synchronizing using the IR port on your handheld
- Using your company's network to synchronize information
- Choosing whether to synchronize information for a specific application

**Wi-Fi**

Synchronizing wirelessly using your handheld's built-in Wi-Fi capabilities

**Bluetooth**

Synchronizing wirelessly using your handheld's built-in Bluetooth technology

# Your Photo and Video Organizer

## In this chapter

[Copying photos and videos](#)

[Viewing photos and videos](#)

[Organizing photos and videos into albums](#)

[Sending a photo or video using Bluetooth® wireless technology](#)

[Beyond the basics](#)

A picture may be worth a thousand words, but what happens when you have a lots of pictures—or videos—that you are trying to keep organized? Or maybe just a few that are so meaningful that you want to have instant access to them at any time?

Solve both problems with the Media application. Media features easy viewing and organization of still photos and videos. You can keep your favorite photos right on your handheld; **select photos as the background** for your Favorites and Applications views and for Agenda View in Calendar; even **add a photo to a Contacts entry.**

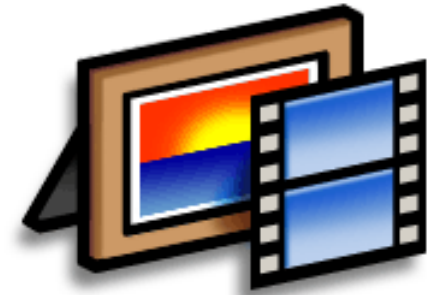

## Benefits

- Never be far from your favorite people or places
- Simplify photo and video organization
- Store multiple videos and hundreds of photos

**[ ! ] Before You Begin**

You must **synchronize** your handheld with your computer once before you can copy photos and videos to your handheld.

**\* Tip**

You can also copy photos and videos to an expansion card, and then view them by inserting the card into your handheld's expansion card slot.

## Copying photos and videos

You can copy photos and videos to your handheld in the following ways:

- On a Windows computer, open the **Media application from within Palm® Desktop software**, drag the photos or videos into the Media window, and then synchronize.
- On a Mac computer, drag the photos or videos onto the **Send To Handheld droplet** icon, and then synchronize.

On a Windows computer, when you copy a photo in a popular format—such as JPG, BMP, TIFF (uncompressed), and GIF—to your handheld, the photo is saved on your handheld in its original format. If you copy a photo in a different format, it is saved on your handheld in JPG format.

On a Mac computer, all photos you copy using the Send To Handheld droplet icon are saved on your handheld in JPG format.

When you copy a video from your Windows or Mac computer, the video is converted to a format your handheld can play and is optimized for viewing on the handheld. Note, however, that there are numerous video formats, and not all types can be converted to a format that's viewable on your handheld. To test a video on your Windows computer, try to open and view the video in the desktop Media application; if you can't view the video on your computer, you won't be able to view the video on your handheld.

- \* **Tip**  
 Select Slide Show to display all photos and videos in an album, automatically one after another. Tap a photo or video to stop the slide show.



## Viewing photos and videos

1

Tap Media  in the input area.

2

Go to the album where the photo or video is located:

- a. Select either Handheld  or Expansion card .

**NOTE** The Handheld and Expansion card icons appear only if an expansion card is inserted into your handheld's expansion card slot.

- b. Select the location pick list at the top of the screen, and then select the location of the photo or video you want to view. Select All Albums to view all photos and videos on your handheld or on the expansion card.

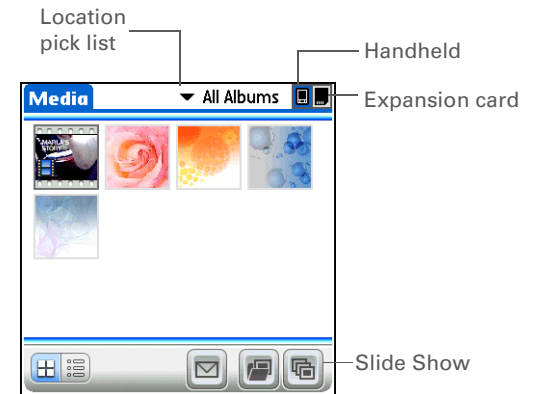

↘ Continued

- \* **Tip**  
If you are viewing a photo, you can also press Center to return to the selection screen.

**3**

Select the photo or video you want to view. Tap anywhere in the photo or video to return to the selection screen.

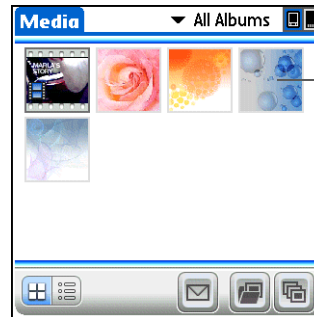

Select a photo or video to view



Tap the photo or video to return to the selection screen

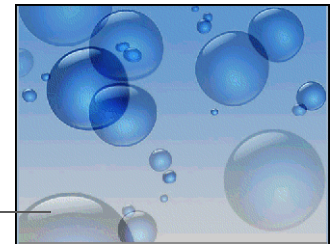

↙ Continued



\* **Tip**

If a video appears cropped in portrait view, tap the video to return to the selection screen, **rotate the screen** to landscape view, and then select the video again to get a full-screen view.

+ **Did You Know?**

The input area is automatically hidden when you view a video.

## 4

**[ & ] OPTIONAL** Access controls:

- For photos, press Up on the 5-way navigator to zoom in. Press Down to access the photo controls.
- For videos, press Center to access video controls.

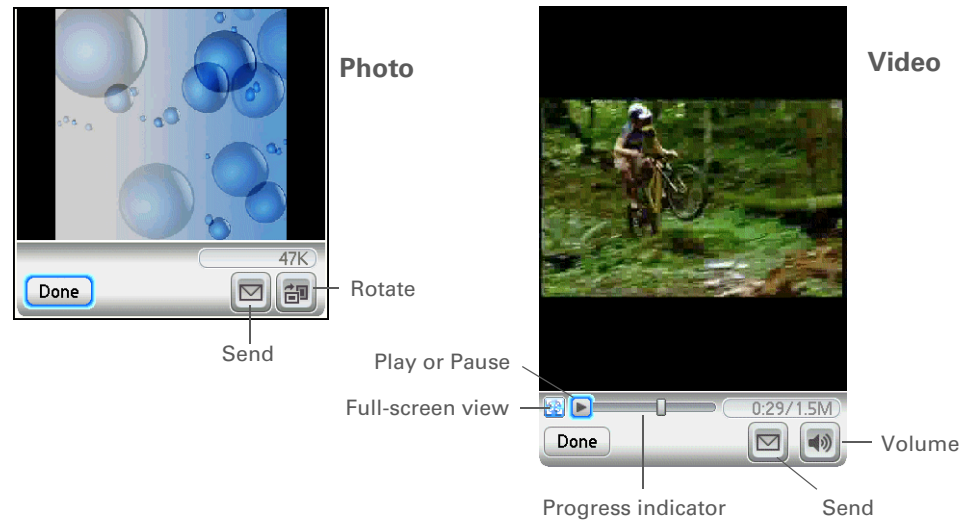

↓ Done

**\* Tip**

If a photo is stored on your handheld, you can add it only to an album located on the handheld. Likewise, if a photo is stored on an expansion card, you can add it only to an album that is on the same card.

## Organizing photos and videos into albums

**1**

Tap Media  in the input area.

**2**

Select Manage Albums .

↳ Continued

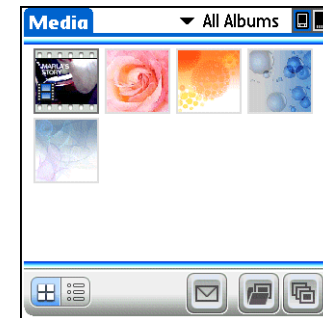

**\* Tip**

If you want to add or remove photos or videos in any album, select **Manage Albums** from **Thumbnail** or **List** view, select the album you want, and then select **OK**. Follow the directions in step 4 for adding or removing items in an album.

**3**

Create an album:

- a. Select whether to create the album on your handheld (Device) or on an expansion card inserted into the expansion card slot (Card).
- b. Select **New**, enter the name of the new album, and then select **OK**.
- c. Select **OK** on the **Manage Albums** screen.

**4**

Add photos or videos to the album you just created:

- a. Select each photo or video you want to add to the album. A plus sign appears to the left of selected items. To remove a photo or video from the album, select it again; the plus sign disappears.
- b. Select **Done**.

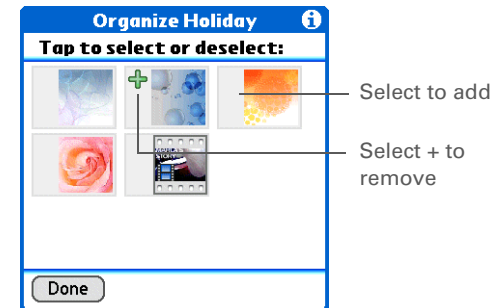

➤ **Continued**

**5**

Move photos or videos within albums:

- a. Select the location pick list at the top of the screen, and then select the album in which you want to move photos or videos.
- b. Select the photo you want to move, and then tap and drag with the stylus to move the photo or video to the desired location.

**NOTE** You cannot move photos or videos in All Albums view.

↓ Done

[!] **Before You Begin**  
**Set up a Bluetooth® connection** on your handheld.

+ **Did You Know?**  
 There are other ways to send photos and videos wirelessly. **Attach the items** to an email message. **Beam the items** to other Palm Powered™ devices. Copy the items to an **expansion card** and then insert the card into another device.

\* **Tip**  
 To send a photo to a device with which you have formed a **partnership**, select the Show pick list and then select Trusted devices on the Discovery Results screen.

## Sending a photo or video using Bluetooth® wireless technology

You can easily share photos with family and friends. **Use your handheld's built-in Bluetooth wireless technology** to send photos and videos to other wireless devices within range. Sending a file using wireless technology can take some time, so be patient.

1

Tap Media  in the input area.

2

Send a photo or video:

- Select the pick list at the top of the screen, and then select the album containing the photos and/or videos you want to send.
- Highlight the photo or video you want to send.
- Select Send .
- Select Bluetooth, and then select OK.
- Select the device to which you want to send the photo or video, and then select OK. The file is sent automatically.

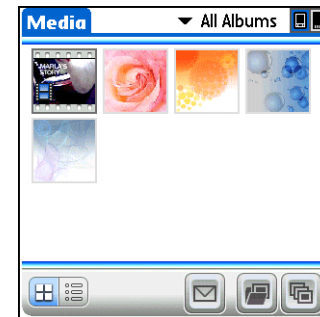

↓ Done

**User Guide**

For everything you need to know about your handheld—all that's in this guide, and much more—go to [www.palm.com/TX-userguide](http://www.palm.com/TX-userguide).

**Tips & Tricks**

Make your handheld uniquely yours. For great tips, software, accessories, and more, visit [www.palm.com/myTX](http://www.palm.com/myTX).

**Support**

If you're having problems with Media or with anything else on your handheld, go to [www.palm.com/support](http://www.palm.com/support).

## Beyond the basics

Click the link to the *User Guide* on the web and learn about these related topics:

**Media**

- Viewing photos and videos as thumbnails, lists, albums, and slide shows
- Copying photos and videos to other applications or expansion cards
- Deleting photos and videos

**Sharing**

Sending information using wireless technology on your handheld

**Email**

Sending photos and videos as attachments to email messages

# Your MP3 Player

## In this chapter

[Using Rhapsody as your desktop music application](#)

[Setting up Rhapsody for MP3](#)

[Transferring MP3 files to your handheld](#)

[Transferring music from a CD to your handheld](#)

[Playing music on your handheld](#)

[Beyond the basics](#)

Are you tired of listening to small talk during that long commute on the bus or train? Do you need something smaller than a CD player when you're out for a walk or at the gym? No need to buy an expensive MP3 player. Your handheld can carry lots of your favorite songs, and Pocket Tunes™ lets you play the music on your handheld. Simply transfer songs onto your handheld or an expansion card and then listen through the built-in speaker or stereo headphones (sold separately).

**NOTE** Mac users cannot transfer music files directly to your handheld. You must insert an expansion card into your handheld's expansion card slot, transfer the music files to the card, and then listen to the files from the card.



## Benefits

- Carry and listen to songs in the popular MP3 format
- No separate MP3, CD, or mini-disc player required
- Arrange your favorite songs into playlists on your handheld

**\* Tip**

If you do not have Internet access, you can still enjoy music on your handheld. Use **Quick Install** to copy music files to an expansion card, insert the card into your handheld's expansion card slot, and then use the Pocket Tunes application to listen to the songs on the card.

## Using Rhapsody as your desktop music application

The Pocket Tunes software that comes with your handheld is compatible with the popular MP3 audio file format. If your MP3 files are already on your computer's hard drive, you need to transfer them to your handheld to listen to them. You can use Rhapsody as your desktop music application to transfer files to your handheld.

**NOTE** An Internet connection is required to download Rhapsody and install it on your computer desktop.

Rhapsody has many advanced features that make it the recommended desktop music application:

- Rip CDs into MP3 format.
- Easily manage your music library on your desktop computer.
- Create playlists.
- Transfer music from your computer to your handheld.



**[ ! ] Before You Begin**

(Windows only) Perform the following:

- Install the Rhapsody desktop application on your computer. Insert the software installation CD and follow the onscreen instructions for installing extra software. You should install this software even if you already have a version of Rhapsody installed on your computer, because it contains all of the components needed to transfer music files to your handheld. An Internet connection is required to download the software.
- After you install the software, **synchronize** your handheld with your computer so that Rhapsody can recognize your handheld.

## Setting up Rhapsody for MP3

**WINDOWS ONLY**

To be compatible with Pocket Tunes, Rhapsody settings must be changed to support MP3.

**NOTE** The following procedure works with the version of Rhapsody you can download from the software installation CD. We recommend that you install this version even if you already have Rhapsody on your computer. If you choose to use a different version, the procedure steps may be different.

**1**

Prepare your computer and your handheld:

- a. **Connect your handheld and your computer to the USB sync cable.**
- b. On your handheld, **go to Favorites** and select Music .

➤ **Continued**

**2**

Set the Rhapsody format setting on your computer:

- a. Open the Rhapsody application on your computer.
- b. Click Tools, and then click Preferences.
- c. Click CD Importing & Playing.
- d. Select MP3 from the Format (codec) drop-down list.
- e. Click OK.

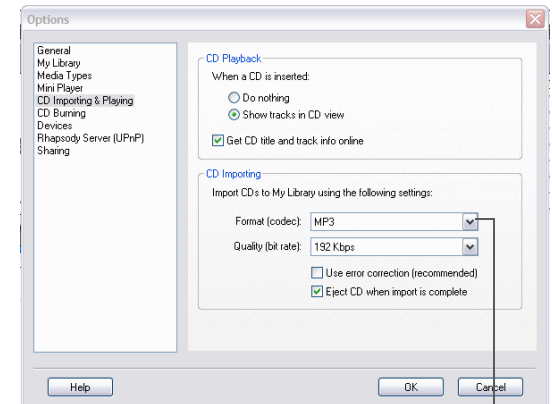

Select mp3



Done

You have now set up Rhapsody to import and play MP3 files.

[ ! ] **Before You Begin**  
(Windows only) You must set up **Rhapsody to support MP3 files.**

## Transferring MP3 files to your handheld

The Pocket Tunes software that comes with your handheld is compatible with the popular MP3 audio file format. If your MP3 files are already on your computer's hard drive, you need to transfer them to your handheld to listen to them on your handheld.

### WINDOWS ONLY

**1**

Prepare your computer and your handheld:

- a. **Connect your handheld and your computer to the USB sync cable.**
- b. On your handheld, **go to Favorites** and select Music .

↘ Continued

\* **Tip**  
If your handheld does not appear in the drop-down list in step 2, close Rhapsody, **install the Pocket Tunes plug-in** from the CD, and then open Rhapsody again.

## 2

Prepare Rhapsody on your computer:

- a. Open the Rhapsody application.
- b. Click the Transfer tab in the Mixer window.
- c. Click the Device Preferences  button and select your handheld from the drop-down list.
- d. Click the location, such as My Library, where the songs are stored on your computer.

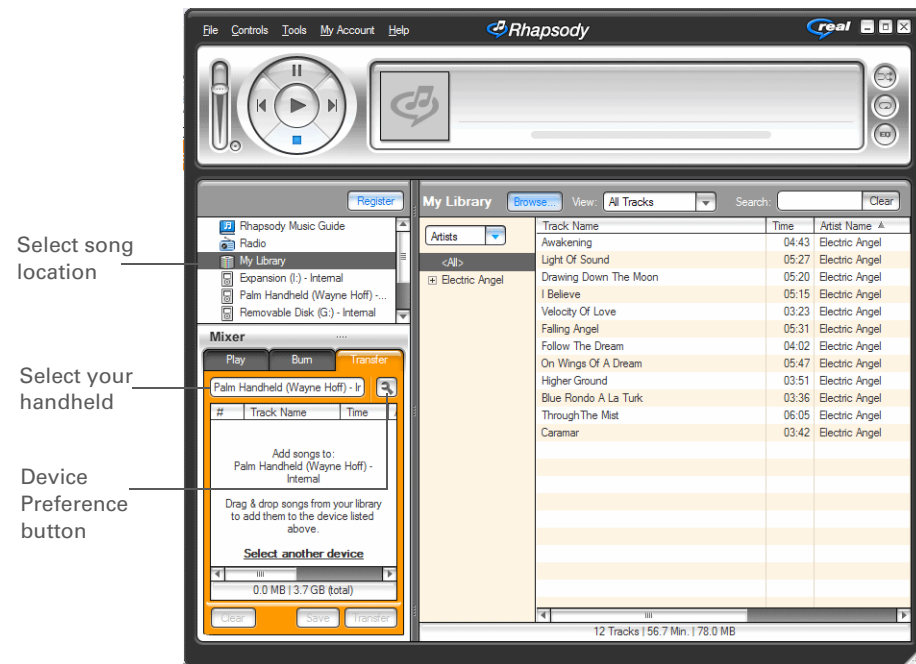

➤ Continued

## 3

Transfer the files to your handheld:

- a. Drag the song files you want from the song location window into the Transfer window.
- b. Click Transfer. The files are transferred to your handheld.

**[ ! ] IMPORTANT** Do not press the sync button on your cable. Rhapsody is transferring the files, so there's no need to do anything.

↓ Done

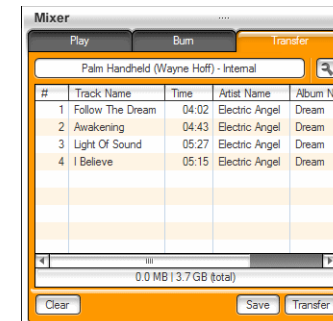

**\* Tip**

You can also use a card reader accessory (sold separately) to transfer MP3 files from your computer to an expansion card.

**MAC ONLY**

Mac users must transfer music files to an expansion card inserted into your handheld's expansion card slot.

**1**

**Connect your handheld and your computer to the USB sync cable.**

**2**

Insert an **expansion card** into your handheld's expansion card slot.

**3**

Select the MP3 files you want to transfer:

- a. Drag and drop the MP3 files onto the Send To Handheld droplet in the Palm folder.
- b. In the Send To Handheld dialog box, select your username and click OK.

**4**

**Synchronize your handheld with your computer.**

**NOTE** Be patient; transferring music to an expansion card can take several minutes.

↓ Done

[!] **Before You Begin**  
(Windows only) You must set up **Rhapsody to support MP3 files.**

## Transferring music from a CD to your handheld

If your songs are on a CD and you want to listen to them on your handheld, use the Rhapsody desktop application on your computer to convert and transfer the files.

**NOTE** Mac users can use iTunes, included with OS X, to transfer music from a CD to your computer, and then use the Send To Handheld droplet to transfer the files to your handheld. Music files should be imported in MP3 format.

### WINDOWS ONLY

1

Access the music CD from Rhapsody on your computer:

- a. Open the Rhapsody application.
- b. Insert the music CD into your computer's CD drive.

↘ Continued

+ **Did You Know?**  
An interactive tutorial on the software installation CD guides you through adding music. Insert the CD, go to the My Music section of the tutorial, and then select Add music from a CD.

+ **Did You Know?**  
For tips on using Rhapsody on your computer, go to the Help menu in Rhapsody or visit [www.real.com](http://www.real.com).

**2**

Transfer the songs you want to add to your library:

- a. Select the titles you want to transfer from the CD.
- b. Click Import CD.

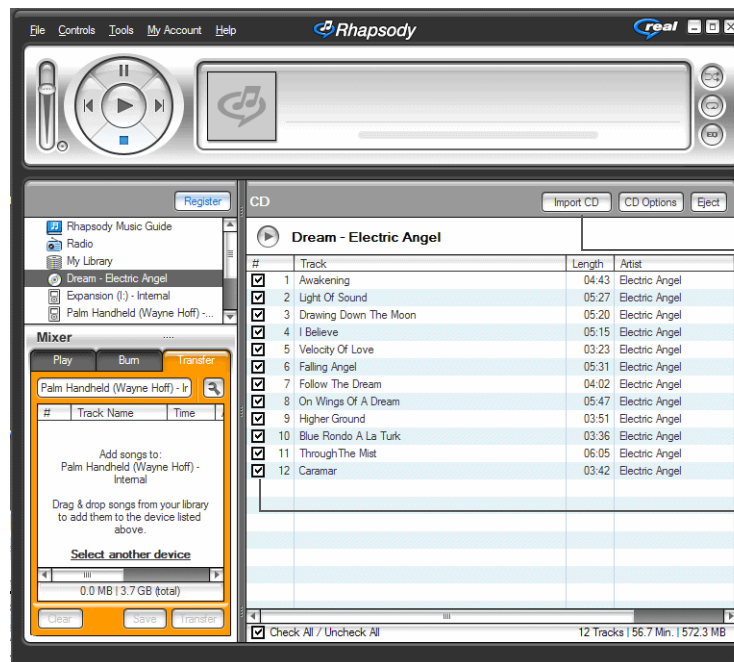

Import  
CD

Select  
titles

**3**

**Transfer the MP3 files to your handheld.**

↓ Done



+ **Did You Know?**  
Pocket Tunes continues playing the songs in your list until it reaches the end of your list or until you tap Stop, even if your handheld screen is off.

\* **Tip**  
You can upgrade Pocket Tunes to a version that supports additional music file formats, such as WMA; supports streaming music; and includes additional features such as graphic equalizers and bookmarks. For more information, visit [www.pocket-tunes.com/palm](http://www.pocket-tunes.com/palm).

## Playing music on your handheld

1

**Go to Favorites** and select Music .

2

Select a song to play:

- To play the current song, tap Play.
- To play a different song, tap Choose song and select a song from the list.



3

When you've finished listening, tap Stop.

↓ Done

**User Guide**

For everything you need to know about your handheld—all that's in this guide, and much more—go to [www.palm.com/TX-userguide](http://www.palm.com/TX-userguide)

**Tips & Tricks**

Make your handheld uniquely yours. For great tips, software, accessories, and more, visit [www.palm.com/myTX](http://www.palm.com/myTX)

**Support**

If you're having problems with Pocket Tunes, go to [www.pocket-tunes.com](http://www.pocket-tunes.com).

## Beyond the basics

Click the link to the *User Guide* on the web and learn about these related topics:

**Pocket Tunes**    Creating playlists by choosing which songs to play and the order to play them in

# Your Microsoft Office File Manager

## In this chapter

[Creating and managing Office files](#)

[Opening files from within Documents](#)

[Beyond the basics](#)

With its ability to store important information, your handheld lets you take your office with you—including your Microsoft Office files. With the Documents application, you can carry, view, and edit Microsoft Word and Excel files directly on your handheld, and create files that you can save in native Word or Excel format. You can also view, carry, and manage PowerPoint files on your handheld.

You can keep updated copies of the files on both your handheld and your computer so that you can work on them in the most convenient location any time.



## Benefits

- Manage Word, Excel, and PowerPoint files on your handheld
- Improve productivity by taking important docs, spreadsheets, and presentations with you on the go

**\* Tip**

For complete information on the Documents To Go application, click the application icon on your computer and then click Help, or go to [www.dataviz.com](http://www.dataviz.com).

## Creating and managing Office files

The Documents application provides powerful editing and file management features for Office files on your handheld. What's more, Documents makes it easy for you to share files between your computer and your handheld.

The Documents application has a companion application on your computer called Documents To Go. Use Documents To Go to transfer files to your handheld when you synchronize.

Here are some of the capabilities of Documents:

**NOTE** The Documents application does not support some editing functionality, such as multiple font sizes and spell check.

- View Word, Excel, and PowerPoint files (DOC, XLS, or PPT).
- Create or edit a Word-compatible document or Excel-compatible spreadsheet on your handheld, and then save it in the native DOC or XLS format.
- Create a PowerPoint presentation on your computer, use the Documents To Go desktop application to convert it to a format that is optimized for viewing on your handheld, then synchronize to transfer the file to your handheld. View or edit the file on your handheld, then synchronize again to transfer the changes to the original PowerPoint file on your computer.
- Open Office files received as attachments to incoming **email messages**, and attach files to outgoing messages.

**\* Tip**

When you are working on a file, save it to your handheld or to an expansion card by selecting Menu, selecting Save As from the File menu, and then selecting the location where you want to save the file.

## Opening files from within Documents

In the Documents application, you can view and open any Word, Excel, or PowerPoint file on your handheld.

**1**









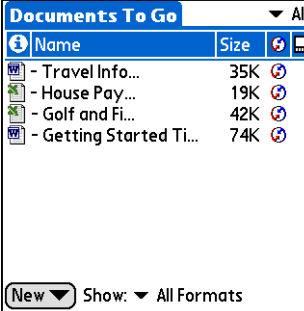



Tap Documents  in the input area.

**2**

Select the file you want from the list.

↓ Done



Documents To Go			▼ All
Name	Size		
 - Travel Info...	35K		
 - House Pay...	19K		
 - Golf and Fi...	42K		
 - Getting Started Ti...	74K		

New ▼ Show: ▼ All Formats

**User Guide**

For everything you need to know about your handheld—all that's in this guide, and much more—go to [www.palm.com/TX-userguide](http://www.palm.com/TX-userguide).

**Tips & Tricks**

Make your handheld uniquely yours. For great tips, software, accessories, and more, visit [www.palm.com/myTX](http://www.palm.com/myTX).

**Support**

If you're having problems with Documents, click the Documents To Go icon on your computer and then click Help, or go to [www.dataviz.com](http://www.dataviz.com).

## Beyond the basics

Click the link to the *User Guide* on the web and learn about these related topics:

**Email**                      Sending and receiving Office files as attachments to email messages

# Your Personal Information Organizer

## In this chapter

[Organizing your personal information](#)

[Managing your contacts](#)

[Managing your calendar](#)

[Managing your tasks](#)

[Beyond the basics](#)

Say good-bye to paper address books and calendars. Free yourself from having to frantically search for a misplaced address or phone number. Throw away all of those half-completed to-do lists that will never get done.

Your handheld is all that you need to organize your personal information and have it available wherever you go. You never lose your information, even if your battery is completely drained. All of your personal information is backed up each time you synchronize, and your information is kept private when you use your handheld's security features. Also, you can easily share info with others electronically.

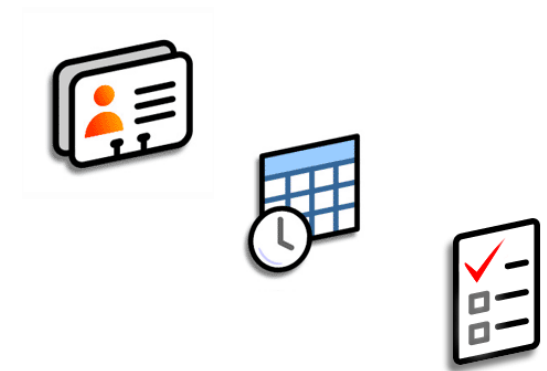

## Benefits

- Carry all your business and personal contact information in your hand
- Track current, future, and past appointments
- Make to-do lists that get done
- Set reminders for appointments, birthdays, important tasks, and more

## Organizing your personal information

You have three powerful tools to help you organize your personal information. These applications can be synchronized with either Palm® Desktop software or Microsoft Outlook.

### Contacts



Easily enter information such as names, addresses, birthdays, and phone numbers. You can even add photos of your contacts, friends, and loved ones directly to their contact information. Quickly view, update, and organize contact information. You can share info with other handhelds and dial phone numbers or send messages directly from a contact entry using your handheld's built-in wireless technology.

### Calendar



Stay on top of your schedule by creating appointments, setting alarms, and spotting conflicts in Calendar. You can view your calendar by day, week, or month, or as an agenda list that combines your list of tasks and email notifications with your appointments. Schedule repeating meetings or block out a vacation by creating one event set to repeat at an interval you specify. Color-code your appointments by category and add notes with helpful information.

### Tasks



Make lists of the things you need to do, and prioritize each task. Track deadlines and stay focused by setting alarms. This is an easy way to stay on top of your to-do list.



\* **Tip**

If the first character you enter in the Last Name or Company field is an asterisk (\*) or another symbol, that contact always appears at the top of the Contacts list. That's useful for an entry like "If Found Call [your phone number]."

+ **Did You Know?**

You can also enter one or more contacts on your desktop computer, and then copy them to your handheld by [synchronizing](#).

## Managing your contacts

Enter and organize all of your contact information for easy access and sharing with others.

### Adding a contact

1

Press Contacts .

2

Add your contact information:

a. Select New.

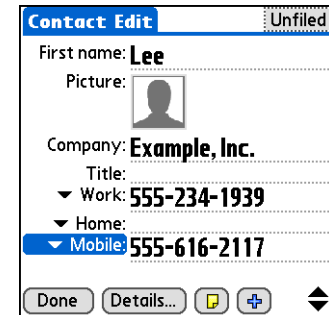
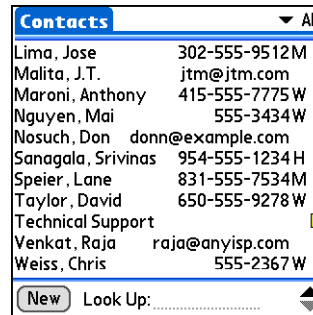

b. Select each field in which you want to enter information, and enter it. Tap the scroll arrows  to view more fields.

 **Continued**

### + Did You Know?

If you want a reminder about a birthday, select the Reminder box, enter the number of days before the birthday that you want to see the reminder, and then select OK.

### \* Tip

Birthdays you enter in Contacts appear as untimed events in Calendar. If you update the birthday in Contacts, it is automatically updated in Calendar as well.

## 3

[ & ] **OPTIONAL** Add a photo:

- Select the Picture box.
- Select and add a photo from the Media application.

**Contact Edit** Unfiled

First name: **Lee**

Picture:  Tap here



Company: **Example, Inc.**

Title:

Work: **555-234-1939**

Home:

Mobile: **555-616-2117**

Done Details...  

## 4

[ & ] **OPTIONAL** Add a birthday:

- Select the Birthday box.
- Select the birth year, month, and date.

**Contact Edit** Unfiled

Addr(W): **4929 Rockaway Dr.**

City: **Anytown**

State: **CA**

Zip Code: **90000**

Country:

Birthday: **-Tap to add -** Tap here

Custom 1:

## 5

After you finish entering all the information you want, select Done.





**Done**



That's it. Your handheld automatically saves the contact. Make sure you have a current backup. **Synchronize often.**

## + Did You Know?

**Phone Lookup** in the Options menu of many applications lets you add contact information when you are creating an entry in another application.

## Locating a contact on your list

<b>1</b>	Press Contacts  .
<b>2</b>	<p>Search for the contact:</p> <p>a. Select the Look Up line at the bottom of the screen and enter the first letter of the name you want to find.</p> <p>b. Enter the second letter of the name, and so on, until you can easily scroll to the contact you want.</p>
<b>3</b>	<p>Select the contact to open it.</p> <p style="text-align: center;"> Done</p>

<b>Contacts</b> <span style="float: right;">▼ All</span>	
Lima, Jose	302-555-9512M
Malita, J.T.	jtm@jtm.com
Maroni, Anthony	415-555-7775 W
Nguyen, Mai	555-3434W
Nosuch, Don	donn@example.com
Sanagala, Srivinas	954-555-1234 H
Speier, Lane	831-555-7534M
Taylor, David	650-555-9278 W
Technical Support 	
Tsai, Lee	555-234-1939 W
Venkat, Raja	raja@anyisp.com
<input type="button" value="New"/> Look Up: marl ..... 	

**\* Tip**

You can create a contact with your own information and select it as your business card by **opening the Record menu** and selecting Business Card. Beam your business card to other handhelds by holding down the Contacts button until the Beam dialog box appears.

**+ Did You Know?**

A Beam command appears on the leftmost menu of most applications. Beam information such as photos or appointments.

**\* Tip**

You can also **send information** to other devices using your handheld's built-in Bluetooth® wireless technology.

**Beaming a contact****1**

Press Contacts .

**2**

Beam the contact:

- Locate the contact** you want to beam.
- Open the menus.**
- Select Record, and then select Beam Contact.
- When the Beam Status dialog box appears, point your handheld's IR port directly at the IR port of the other handheld.



**NOTE** For best results, the handhelds should be between 4 and 36 inches apart, and there should be a clear path between them. Depending on the receiving handheld model, not all information may be sent correctly.

**3**

Wait for the Beam Status dialog box to indicate that beaming is complete.

 Done

## » Key Term

**Event** The name for an entry in the Calendar application, including appointments, birthdays, reminders, recurring meetings, and so on.

## \* Tip

You can also scroll to a date by pressing Left or Right on the 5-way navigator or by tapping the arrows at the top of the Day View.

## + Did You Know?

If you are synchronizing with Outlook, you can **add time zones** to your appointments to keep your calendar current no matter where you are traveling.



## Managing your calendar

Enter appointments to help you organize your time, and then set alarms to remind you before the event so that you have time to prepare.

### Scheduling an appointment

1

Open Day View:

- Press Calendar .
- Tap the Day View icon .

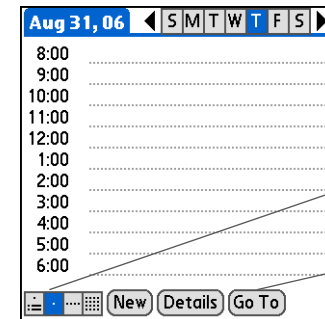

Day View icon

Go To

2

**[ & ] OPTIONAL** If the appointment is not for today, select the date of the appointment:

- Select Go To.
- Select the year, month, and date.

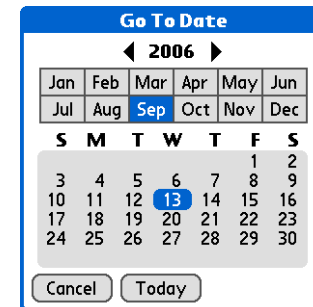

↘ Continued

\* **Tip**  
To enter reminders, holidays, anniversaries, and other events that take place on a particular date but not at a particular time, select No Time.

\* **Tip**  
Color-code your calendar. Tap the bullet next to the description to file the appointment in a category. Each category has its own color.

\* **Tip**  
Are you going to a weekly or multi-day event? You can select Details and then select the Repeat pick list to list the same event for multiple days.

3

Tap the line next to the time the appointment begins, and **enter a description**.

4

If the appointment is longer or shorter than an hour, set the duration:

- In Day View, tap the start time.
- In the Set Time dialog box, select End Time.
- Select the hour and minute lists to select the time the appointment ends.
- Select OK.

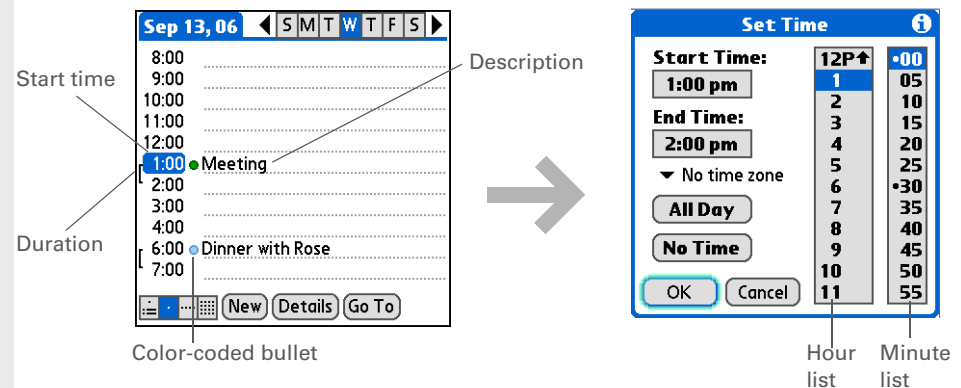

↓ Done

That's it. Your handheld automatically saves the appointment. Make sure you have a current backup. **Synchronize** often.

\* **Tip**  
Press the **Calendar** button repeatedly to cycle through the **Agenda View**, **Day View**, **Week View**, and **Month View**.

\* **Tip**  
You can also display **Year View**. From **Month View**, select **Year**.

+ **Did You Know?**  
You can use a favorite photo as the background for your **Agenda View**.

\* **Tip**  
Calendar opens to **Agenda View** by default, but you can change that to another view by selecting **Display Options** in the **Options menu**.

## Checking your schedule

Sometimes you want to look at your schedule for a particular date, while other times you want to see an overview of a week or month.

- 1 Press **Calendar** .
- 2 Tap the icons in the lower-left corner to see four different **Calendar** views:
 

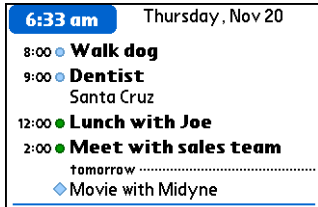

Agenda View

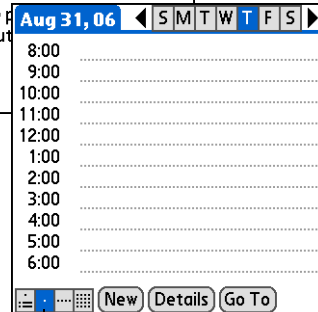

Day View

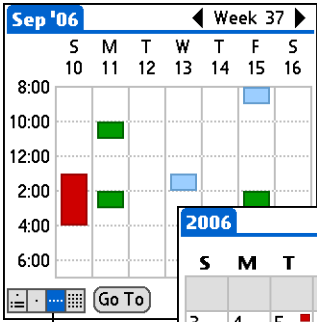

Week View

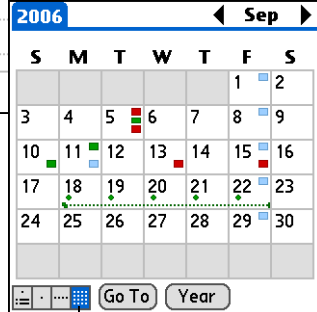

Month View

↓ Done

+ **Did You Know?**  
Setting your alarm sounds in World Clock instead of in Calendar gives you different alarm sound choices.

+ **Did You Know?**  
When you set an alarm, a little alarm clock appears to the right of the event description.

\* **Tip**  
You can beam events to anyone who has a handheld with an IR port. Just **open the Record menu** and select Beam Item or Beam Category.

## Setting an alarm to remind you of a scheduled event

1

Press Calendar .

2

Go to the event you want to assign an alarm to:

- a. From Day View, select Go To.
- b. Select the year, month, and date of the event.
- c. Tap the event description.

3

Set the alarm:

- a. Tap Details.
- b. Check the Alarm box.
- c. Select the pick list and select Minutes, Hours, or Days.
- d. Enter how many minutes, hours, or days before the event you want the alarm to sound, and then select OK.

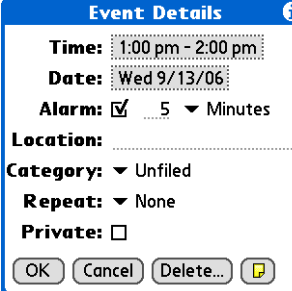

**Event Details** ⓘ

**Time:** 1:00 pm - 2:00 pm

**Date:** Wed 9/13/06

**Alarm:**  5 ▾ Minutes

**Location:** \_\_\_\_\_

**Category:** ▾ Unfiled

**Repeat:** ▾ None

**Private:**

OK Cancel Delete... ⓘ

↓ Done



\* **Tip**  
If no task is currently selected, you can create a new task simply by starting to write in the input area.

\* **Tip**  
Set an alarm for a task with a due date. Select the task, tap Details, select the Alarm box, check the Alarm box, enter the alarm settings, and then select OK.

## Managing your tasks

Create and organize your to-do list, and then track your progress.

### Creating a task

1

**Go to Favorites** and select Tasks .

2

Create a task:

- Select New.
- Enter a description of the task.

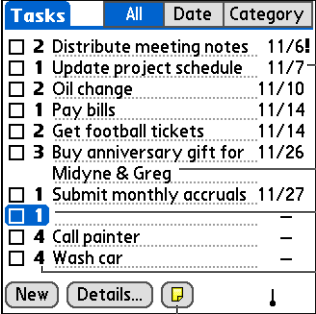

Tasks	All	Date	Category
<input type="checkbox"/> 2	Distribute meeting notes	11/6!	
<input type="checkbox"/> 1	Update project schedule	11/7	
<input type="checkbox"/> 2	Oil change	11/10	
<input type="checkbox"/> 1	Pay bills	11/14	
<input type="checkbox"/> 2	Get football tickets	11/14	
<input type="checkbox"/> 3	Buy anniversary gift for Midyne & Greg	11/26	
<input type="checkbox"/> 1	Submit monthly accruals	11/27	
<input checked="" type="checkbox"/> 1			
<input type="checkbox"/> 4	Call painter	-	
<input type="checkbox"/> 4	Wash car	-	

Due date

Long description

New task

Priority number

Note button

3

**[ & ] OPTIONAL** Assign a priority and due date:

- Select a priority number (1 is the most important).
- Select the Due Date pick list, and then select a date from the list, or select Choose Date to select a date from the calendar.

↓ Done

That's it. Your handheld automatically saves the task. Make sure you have a current backup. **Synchronize often.**

+ **Did You Know?**  
Overdue tasks have an exclamation point (!) next to the due date.

\* **Tip**  
Create a new category for tasks by selecting Edit Categories in the Category pick list.

## Organizing your tasks

Sometimes you want to look at all the things you need to do, while at other times you want to see only certain types of tasks.

**1** Go to Favorites and select Tasks .

**2** In the Tasks list, select one of these options:

**All** Displays all your tasks.

**Date** Displays tasks that are due in a specific time frame. Select the pick list in the upper-right to select Due Today, Last 7 Days, Next 7 Days, or Past Due.

**Category** Displays tasks that are assigned to the selected category: Business, Personal, and so on. Select the pick list in the upper-right to select a different category.

Tasks	All	Date	Category
<input type="checkbox"/> 2 Distribute meeting notes		11/6!	
<input type="checkbox"/> 1 Update project schedule		11/7	
<input type="checkbox"/> 2 Oil change		11/10	
<input type="checkbox"/> 1 Pay bills		11/14	
<input type="checkbox"/> 2 Get football tickets		11/14	
<input type="checkbox"/> 3 Buy anniversary gift for Midyne & Greg		11/26	
<input type="checkbox"/> 1 Submit monthly accruals		11/27	
<input type="checkbox"/> 4 Call painter		-	
<input type="checkbox"/> 4 Wash car		-	

Tasks	All	Date	Category
<input type="checkbox"/> 2 Distribute r		Due Today - 1	
<input type="checkbox"/> 1 Update pro		Last 7 Days - 2	
		Next 7 Days - 3	
		Past Due - 1	

Tasks	All	Date	Category
<input type="checkbox"/> 2 Distribute mee			Business
<input type="checkbox"/> 1 Update projec			Personal
<input type="checkbox"/> 1 Submit monthl			Unfiled
			Edit Categories...

 Done

**\* Tip**

You can set Task Preferences to record the date that you finish your tasks, and you can show or hide finished tasks. To change these settings, **open the Options menu** and select Preferences.

**Marking a task complete**

You can check off a task to indicate that you've completed it.

**1**      **Go to Favorites** and select Tasks .

**2**      Check the box on the left side of the task.

 Done

Tasks	All	Date	Category
▼ Personal			
<input checked="" type="checkbox"/> 4 Wash car		11/7	
<input checked="" type="checkbox"/> 2 Oil change		11/7	
<input type="checkbox"/> 1 Pay bills		11/14	
<input type="checkbox"/> 3 Buy anniversary gift for Midyne & Greg		11/26	
<input type="checkbox"/> 4 Call painter		-	

**NOTE** Palm® Desktop software and Microsoft Outlook handle completed repeating tasks differently. Palm Desktop software checks off all overdue instances of the task, and Microsoft Outlook checks off only the oldest instance of the task.

### User Guide

For everything you need to know about your handheld—all that's in this guide, and much more—go to [www.palm.com/TX-userguide](http://www.palm.com/TX-userguide).

### Tips & Tricks

Make your handheld uniquely yours. For great tips, software, accessories, and more, visit [www.palm.com/myTX](http://www.palm.com/myTX).

### Support

If you're having problems with organizer applications or with anything else on your handheld, go to [www.palm.com/support](http://www.palm.com/support).

## Beyond the basics

Click the link to the *User Guide* on the web and learn about these related topics:

- |                    |   |
|--------------------|---|
| <b>Contacts</b>    | <ul style="list-style-type: none"><li>• Displaying additional contact fields and defining custom fields</li><li>• Using Quick Connect to make a phone call, address and send an email or text message, or go to a web page directly from a contact</li></ul>  |
| <b>Calendar</b>    | <ul style="list-style-type: none"><li>• Setting a time zone for an individual appointment different from the time zone of the location you set for your handheld</li><li>• Reserving blocks of time for long events like vacations or conferences</li></ul>   |
| <b>Tasks</b>       | <ul style="list-style-type: none"><li>• Creating repeating tasks for things you need to do at regular intervals, such as taking out the trash on Thursday night or filing a weekly status report</li><li>• Setting preferences to choose which tasks appear in the Tasks list, whether to track completion dates, and which alarm sound plays</li></ul> |
| <b>Categories</b>  | Organizing items by type and sorting them   |
| <b>Moving Info</b> | Transferring information from other applications such as databases, spreadsheets, and other organizer software  |
| <b>Privacy</b>     | Keeping information private by turning on security options  |
| <b>Sharing</b>     | Sending information wirelessly using Bluetooth wireless technology on your handheld   |
| <b>Email</b>       | Sending information as attachments to email messages  |

# Your Memos and Notes

## In this chapter

[Organizing your memos and notes](#)

[Managing your memos](#)

[Managing your notes](#)

[Beyond the basics](#)

Throw away your yellow sticky notes, lists, and memo pads. You no longer have to organize your scraps of paper or search through piles for a misplaced memo. When an important idea pops into your head, jot it down it before you forget.

Your handheld is all that you need to organize your notes and memos. Also, you can easily share info with others electronically.



## Benefits

- Capture thoughts on the fly
- Send memos and notes to colleagues wirelessly
- Synchronize your information to back it up on your computer

## Organizing your memos and notes

You have two powerful tools to help you organize your memos and notes. Memos can be synchronized with either Microsoft Outlook (where it is called Notes) or Palm<sup>®</sup> Desktop software. Note Pad can be synchronized only with Palm Desktop software.

### Memos



Capture information that is meaningful to you, from meeting notes to recipes and favorite quotations. Memos provides a quick and easy way to enter, store, and share your important information.

### Note Pad



Draw freehand and take notes in your personal handwriting. Use Note Pad to do everything you might do with a piece of paper and a pencil, such as drawing a quick sketch.

\* **Tip**  
In the Memos list, you can also just start writing to create a new memo. The first letter is automatically capitalized.

\* **Tip**  
Use **Phone Lookup** to quickly add a name and phone number to a memo.

## Managing your memos

Create memos that are titled and organized so you can easily find them.

### Creating a memo

1

**Go to Favorites** and select Memo .

2

Create a memo:

a. Select New.

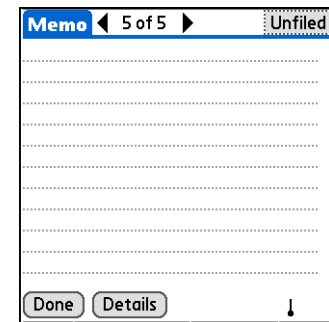
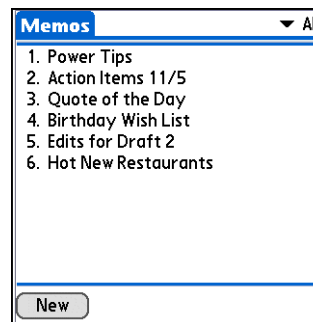

b. Enter your memo. Tap Enter on the onscreen keyboard or draw the **Graffiti® 2 writing** Return stroke  to move to a new line in the memo.

c. Select Done.



Done

That's it. Your handheld automatically saves the memo. Make sure you have a current backup. **Synchronize** often.

\* **Tip**

The Memos list shows the first line of each memo, so make sure that first line is something you will recognize.

+ **Did You Know?**

You can connect your handheld to a portable keyboard to easily type your memos on the go. To view a variety of portable keyboards for your handheld, visit [www.palm.com/myTX](http://www.palm.com/myTX) and click the Accessories link.

## Viewing and editing a memo

1

**Go to Favorites** and select Memo .

2

View or edit the memo:

a. In the Memos list, select the memo you want.

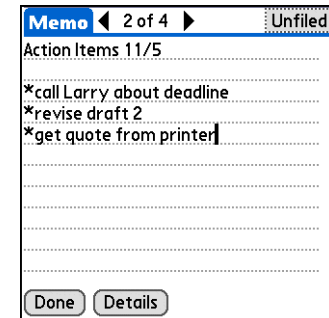
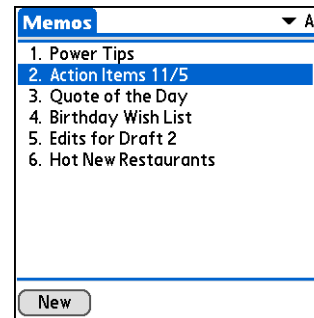

b. Read or edit the memo, and then select Done.

↓ Done



**[ ! ] Before You Begin**

Make sure **full-screen writing is turned off**. You cannot create or edit notes in Note Pad when full-screen writing is on.

**\* Tip**

You can change the color of the pen and paper (background). From the Note Pad list screen, **open the Options menu**, select Preferences, and then select Color.

**\* Tip**

Tap the pen selector to change the pen width or to select the eraser.

## Managing your notes

You can quickly create handwritten notes and sketches of your thoughts and ideas.

### Creating a note

1

**Go to Applications** and select Note Pad .

2

Create a note:

- Use the stylus to write your note directly on the handheld screen.
- Select the time at the top of the screen and enter a title using **Graffiti 2 writing** or the **onscreen keyboard**.
- Select Done.

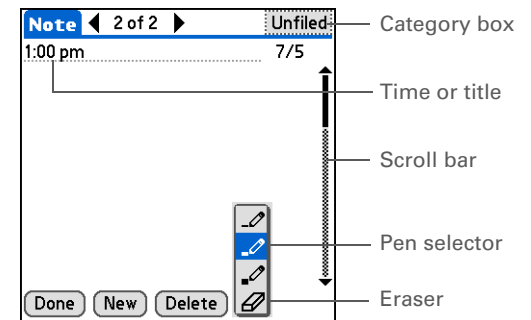

Done

That's it. Your handheld automatically saves the note. Make sure you have a current backup. **Synchronize** often.

\* **Tip**

Sort the Note Pad list alphabetically, by date, or manually. **Open the Options menu**, select Preferences, and then select the Sort by pick list.

If you sort manually, you can rearrange the list by dragging notes to another position in the list.

**Viewing and editing a note****1**

**Go to Applications** and select Note Pad .

**2**

Open the note:

- a. Select Done to display the Note Pad list.
- b. Select the note you want to view or edit.

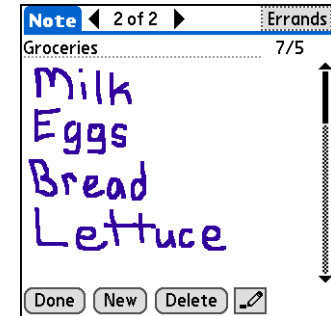
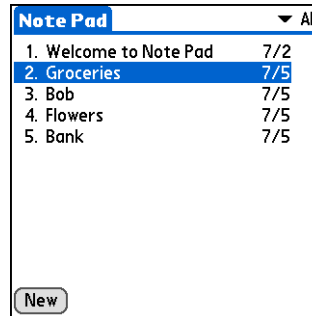
**3**

Read or edit the note, and then select Done.

↓ Done

**User Guide**

For everything you need to know about your handheld—all that's in this guide, and much more—go to [www.palm.com/TX-userguide](http://www.palm.com/TX-userguide).

**Tips & Tricks**

Make your handheld uniquely yours. For great tips, software, accessories, and more, visit [www.palm.com/myTX](http://www.palm.com/myTX).

**Support**

If you're having problems with Memos or Note Pad or with anything else on your handheld, go to [www.palm.com/support](http://www.palm.com/support).

## Beyond the basics

Click the link to the *User Guide* on the web and learn about these related topics:

<b>Memos</b>	<ul style="list-style-type: none"><li>• Deleting memos</li><li>• Sending memos to your computer by synchronizing, so you can cut text from a memo and paste it into an application such as Microsoft Word</li></ul>
<b>Notes</b>	Setting alarms when you use notes as reminders
<b>Categories</b>	Organizing items by type and sorting them
<b>Moving Info</b>	Transferring information from other applications such as databases, spreadsheets, and other organizer software
<b>Privacy</b>	Keeping information private by turning on security options
<b>Sharing</b>	Sending information wirelessly using Bluetooth® wireless technology on your handheld
<b>Email</b>	Sending information as attachments to email messages

# Your Wireless Connections

## In this chapter

[What can I do with built-in wireless technology?](#)

[When would I use Wi-Fi or Bluetooth technology?](#)

[Setting up a Wi-Fi network connection](#)

[Entering basic Bluetooth® settings](#)

[Setting up a Bluetooth® phone connection](#)

[Accessing email and the web with Bluetooth® wireless technology](#)

[Setting up a connection for Bluetooth synchronization](#)

[Beyond the basics](#)

Staying connected means you have the latest wireless technology at your fingertips at all times. Now your handheld can connect you to the wireless world using either Wi-Fi® or Bluetooth® wireless technology.

When you're in range of a network "hot spot," use Wi-Fi to access a home, public, or corporate network. When you're with friends who have compatible devices, use Bluetooth wireless technology to share your contacts or your favorite photos.



## Benefits

- Connect to home and public wireless networks
- Connect to your Bluetooth phone to send text or email messages or to access the web
- Reduce cable clutter by synchronizing wirelessly
- Connect to other devices to share files wirelessly

## » Key Term

**Wi-Fi** Wireless technology that allows devices such as handhelds, printers, and computers to connect wirelessly to the Internet and to corporate, home, and public networks through network access points.

## » Key Term

**Bluetooth** Technology that enables devices such as handhelds, mobile phones, and computers to connect wirelessly to each other within a 30-foot range.

## What can I do with built-in wireless technology?

**Access your corporate network.** Whether you are attending a meeting or roaming the hallway, you can stay connected to the information you need.

**Send and receive email messages.** Whether you send and receive email messages once a week or constantly throughout the day, wireless connectivity means that you can share information.

**Access the web.** Connect to the Internet for news and information in a cafe, in a meeting, or in your car.

**Reduce cable clutter by synchronizing wirelessly.** Imagine your desk and workstation without cable clutter. Wireless technology on your handheld replaces many of the connecting cables with a wireless connection for tasks such as synchronizing.

**Connect to other devices to share files wirelessly.** Wouldn't it be great if you could transfer files such as photos wirelessly?

## When would I use Wi-Fi or Bluetooth technology?

You can make many of the same types of connections—browsing the web, checking email, synchronizing wirelessly—using either the Wi-Fi or Bluetooth technology on your handheld. Which one you use depends mainly on your location and circumstances.

**Wi-Fi** Use Wi-Fi technology when you are in range of a Wi-Fi network access point, often called a “hot spot.” This can be in a public location such as a cafe, hotel, or airport; at your job over your company's network; or at home if you have a wireless network set up.

**Bluetooth** Use Bluetooth technology when you are not in range of a Wi-Fi network but are able to make a connection to your mobile phone that is also enabled with Bluetooth technology. This could be at home, on the road, or anywhere else you are in range of your wireless provider's data network.

Also use your handheld's Bluetooth technology to connect directly to other Bluetooth devices, such as computers or handhelds, to send and receive information. Check the documentation included with the other device for instructions on how to set up the device's Bluetooth capabilities.

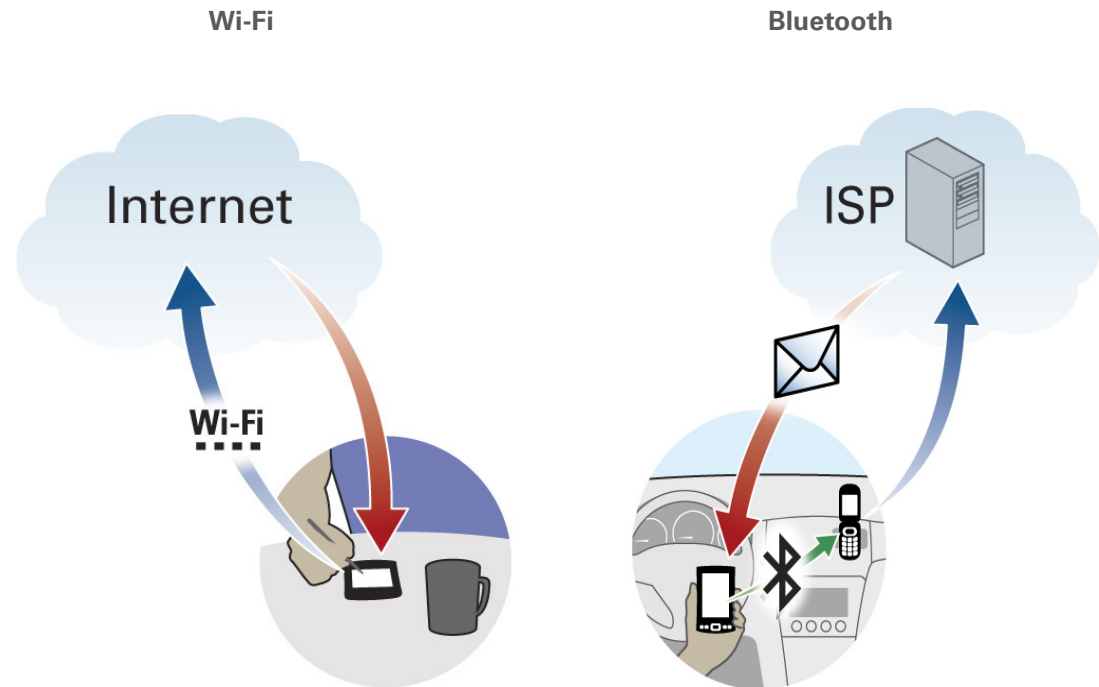

Example: You are at an Internet cafe and want to browse the web. Use your handheld's Wi-Fi technology to wirelessly connect to the cafe's network.

Example: You are out making sales calls and arrive early for an appointment. Use your handheld's Bluetooth technology to connect to your mobile phone and check your email from the car in the parking lot before you go into the appointment.

**[ ! ] Before You Begin**

Check with your system administrator to get the name of the network, also known as an SSID, and the security information, such as WEP or WPA-PSK keys.

**\* Tip**

Once you have set up a connection to a network, connect to it at any time by opening Wi-Fi controls, selecting the network from the Network pick list, and then selecting Connect.

## Setting up a Wi-Fi network connection

**1**

Tap Wi-Fi controls  on the status bar.

**2**

Do one of the following:

- If this is the first time you are setting up a Wi-Fi network connection, select Yes.
- If you have previously set up any network connections and are setting up a new connection, select the Wi-Fi pick list, select On, and then select Scan/Setup.

Your handheld scans for available networks.

➤ Continued

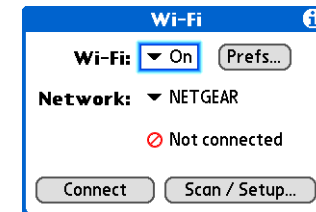
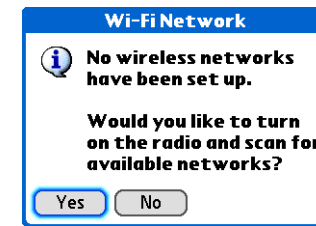

## » Key Term

**Encryption key** A series of letters and numbers that enables data to be encrypted and then decrypted so it can be safely shared within a network. Your handheld supports two encryption systems: WEP and WPA-PSK.

## + Did You Know?

A network that does not appear on the list may be hidden for security purposes.

## 3

Do one of the following:

**The network you want is listed**

Select the network, and then select Connect. If the network does not require an encryption key, the connection process begins. When the process is completed, you are returned to the application you were in when you opened the Wi-Fi controls. You are finished with this procedure.

If the network requires an encryption key, select Yes when asked if you want to enter security settings. Continue with step 4.

**The network you want is not listed** Select Edit, and then select Add. Continue with step 4.

» Continued

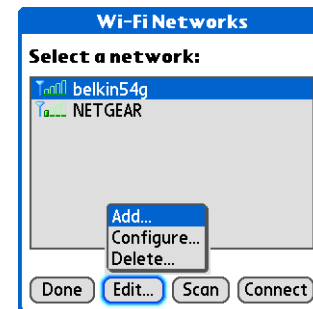
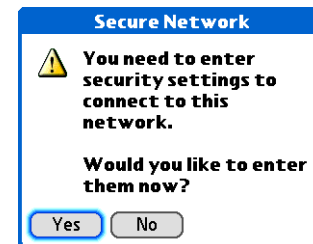
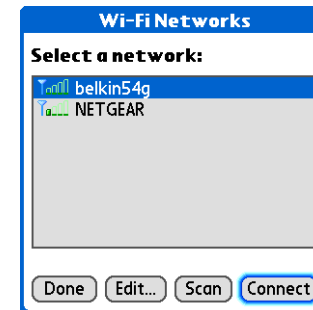



**4**

Add the network name or SSID if it does not appear. An SSID is required for hidden networks.

**5**

Select a security option:

- If your network does not require any encryption settings, select None and go to step 8.
- If your network requires WEP encryption, select WEP and go to step 6.
- If your network requires WPA-PSK encryption, select WPA-PSK and go to step 7.

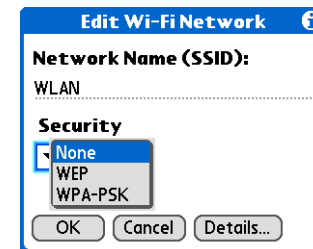

↘ Continued

\* **Tip**  
Check with your system administrator for WEP encryption information.

**6**

If you selected WEP in step 5:

- a. Select the Key box.
- b. Enter the WEP encryption information.
- c. Select OK.

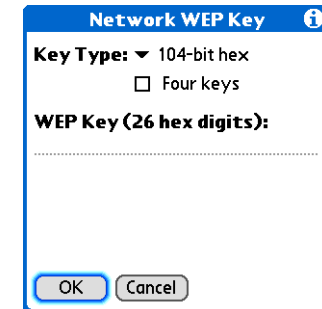

↘ Continued

\* **Tip**  
Check with your system administrator for the WPA-PSK passphrase.

**7**

If you selected WPA-PSK in step 5:

- a. Select the Key box.
- b. Assign a passphrase.
- c. Select OK.

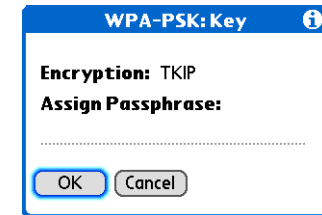
**8**

Select OK in the Edit Wi-Fi Network or New Wi-Fi Network dialog box, and then select Yes when asked if you want to connect to the network. When the connection completes, you are returned to the application you were in when you opened the Wi-Fi controls.

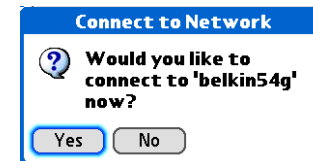

↓ Done

**\* Tip**

When you **enter a URL** in the web browser or select **Get and Send** in the VersaMail® application, a connection is automatically initiated with the last-used service.

## Accessing email and the web using Wi-Fi® functionality

After you set up a connection with a Wi-Fi network, you can send and receive email or browse the web wirelessly using this connection.

**NOTE** Wi-Fi functionality must be on before you can use it to make wireless connections. You must also **set up an email account** on your handheld before you can send or receive email messages.

**1**

Open the **email application** or the **web browser**.

**2**

Tap Wi-Fi controls  on the status bar.

**3**

Make sure that Wi-Fi is set to On.

↘ Continued

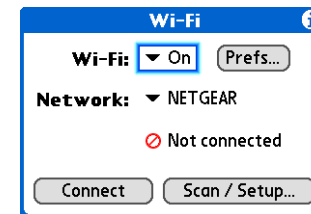

**+** **Did You Know?**  
When Wi-Fi functionality is on, the Wi-Fi icon on the status bar displays signal-strength bars showing the strength of your network connection.

**4**

Connect to the Wi-Fi network:

- a. Select the Network pick list, and then select the network you want.
- b. Select Connect. When the connection is completed, you are returned to the application you were in when you opened the Wi-Fi controls.

**Done**

You are now ready to send and receive email messages or to browse the web.

## » Key Term

**Discoverable** Setting that allows other devices to find and connect with your handheld using Bluetooth wireless technology. If your handheld is not discoverable, other devices cannot find it to make a connection.

## Entering basic Bluetooth® settings

**1**

Tap Bluetooth controls  on the status bar, and then select Prefs.

**2**

Enter the basic Bluetooth settings:

- Select On.
- Tap the Device Name field and enter a name for your handheld. This is the name that other Bluetooth devices see when they connect to your handheld. By default it is the username you use during synchronization, but you can change it.
- Select the Discoverable pick list, and then select Yes or No.

↓ Done

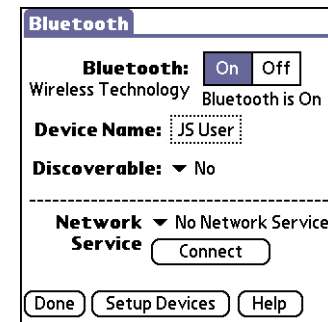

**[ ! ] Before You Begin**

If you have an IR phone, you must download the Phone Link application from the web. Go to [www.palm.com/us/support/downloads/phonelink.html](http://www.palm.com/us/support/downloads/phonelink.html) to download the software.

**\* Tip**

If you receive a message that your phone is not ready to accept a connection, check to make sure that your phone is prepared to make a Bluetooth connection. See the documentation included with your phone for instructions.

**» Key Term**

**GPRS** Acronym for General Packet Radio Service, a method of sending information wirelessly at high speeds.

## Setting up a Bluetooth® phone connection

**[ ! ] IMPORTANT** To set up a phone connection, you must have a GSM or GPRS mobile phone enabled with data services.

**1**

Tap Bluetooth controls  on the status bar.

**2**

Select Setup Devices, select Phone Setup, select Phone Connection, and then select Next.

**3**

Select the phone you want to connect to:

- a. Select the Manufacturer and Model pick lists, select the correct entries for your phone, and then select Next.

If the phone does not appear on the list, check for phone compatibility at [www.palm.com/us/support/downloads/phonelink.html](http://www.palm.com/us/support/downloads/phonelink.html).

- b. The Connection Setup screen displays all Bluetooth phones within range.

If your phone is not listed on the discovery results, check whether your phone is discoverable. Select Find More to search again.

- c. Select the phone you want, select OK, and then select Next.

**NOTE** Not all features are available if your specific phone model is not in the pick list.

 **Continued**

## » Key Term

**Passkey** Like a password, a passkey is a security measure. Connections can happen only between your handheld and a device that has the same passkey.

## » Key Term

**Partnership** Two devices—for example, your handheld and your mobile phone—that can connect to each other because each device can find the same passkey on the other device. Once you form a partnership with a device, you do not need to enter a passkey to connect with that device again.

**4**

Enter a passkey:

- a. Enter a passkey number. This can be any number you choose; it does not have to be, for example, a password you use to access a network or an email account. Entering a passkey creates a partnership between your handheld and your phone.

**[ ! ] IMPORTANT** You must enter the same passkey on your handheld and your mobile phone in order to connect to your phone. We recommend that you use a passkey of 16 digits where possible to improve the security of your handheld. The longer the passkey, the more difficult it is for the passkey to be deciphered.

- b. Select OK.

**5**

Finish phone connection setup and begin network setup:

- a. Select Done, and then select Yes.

**NOTE** If you want to use your phone connection only to dial phone numbers from your handheld or to **send text messages**, select Done, and then select No. You have finished the setup.

- b. Select Next.

**↘ Continued**



\* **Tip**  
Select Yes in step 6 only if you have a GPRS account for your mobile phone.

\* **Tip**  
Contact your ISP (for example, AOL or Earthlink) if you are not sure about one or more of the items to enter in step 8.

**6**

Select the pick list, select Yes or No, and then select Next.

- a. If you select Yes, go to step 7.
- b. If you select No, go to step 8.

**7**

If you selected Yes in step 6:

- a. Select the pick lists, and then select the correct information for your wireless service provider.
- b. Select Next, and then select Done.

**8**

If you selected No in step 6:

- a. Select Next.
- b. Enter the phone number you use to dial in to your Internet service provider, and then enter the username for your dial-up account.
- c. Select the Password box, enter your account password, and select OK. This is the password you use to access your dial-up account; it is not your passkey.
- d. Select Next, and then select Done.

**Done**

**See the next procedure for steps on using your phone connection to browse the web or to send and receive email messages.**

**\* Tip**

You can select Bluetooth controls on the status bar to quickly check Bluetooth status and make a connection from any application on your handheld.

## Accessing email and the web with Bluetooth® wireless technology

After you set up a connection with a mobile phone, you can send and receive email or browse the web wirelessly using this connection.

**NOTE** Bluetooth functionality must be on before you can use it to make wireless connections. You must also **set up an email account** on your handheld before you can send or receive email messages.

**1**

Open the **email application** or the **web browser**.

**2**

Tap Bluetooth controls  on the status bar. Make sure On is selected.

➤ **Continued**

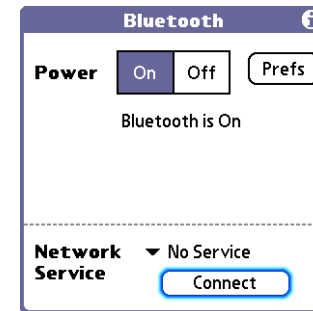

## » Key Term

**Service** Way of connecting to a mobile phone to send information wirelessly, for example, through a high-speed (GPRS) carrier or a dial-up account with an Internet service provider (ISP).

## \* Tip

When you **enter a URL** in the web browser or select **Get and Send** in the VersaMail application, a connection is automatically initiated with the last-used service.

**3**

Connect to your phone:

- a. Select the Network Service pick list and select the service that you want to use to connect to the Internet. If you **set up a phone connection**, the name of the service you configured is listed.
- b. Select Connect.

**Done**

You are now ready to **send and receive email messages** or **browse the web**.

\* **Tip**

To open HotSync® Manager on your computer in step 2 of the onscreen instructions (see procedure step 3b, on this page), click the HotSync Manager icon on the taskbar in the lower-right corner of your computer screen.

\* **Tip**

After the first time you set up a connection and wirelessly synchronize with a computer, you can synchronize with that computer at any time by choosing its device name from the Service pick list and tapping Connect.

## Setting up a connection for Bluetooth synchronization

### WINDOWS ONLY

1

Tap Bluetooth controls  on the status bar, and then select Prefs.

2

Select Setup Devices, select PC Setup, select Bluetooth HotSync, and then select Next.

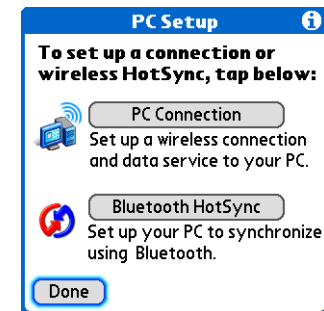

3

Set up a connection for wireless synchronization:

- Follow the onscreen instructions for steps 1–3, selecting Next after each step.
- Select Launch HotSync Manager in step 4.
- Tap the HotSync  icon onscreen to wirelessly synchronize.

↓ Done

## MAC ONLY

1

**Go to Applications** and select **Prefs** .

2

Open the Edit Connection screen:

- a. From the Communications Preferences list, select Connection.
- b. Select New.

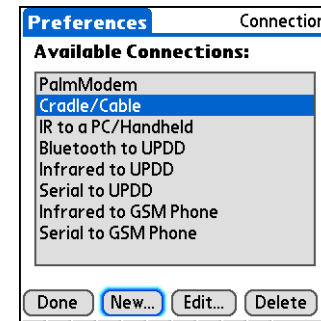

3

Set up the connection to your computer:

- a. Enter a name for the connection, such as BT to Mac.
- b. Select the Connect to pick list, and then select PC.
- c. Select the Via pick list, and then select Bluetooth.

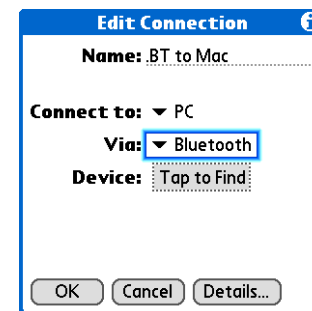

↘ Continued

**\* Tip**

Your passkeys are more secure if you use a different passkey for each device with which you want to connect—one passkey for a connection to a phone, a different one for a connection to a computer, and so on.

**Cont'd.**

d. Make sure the computer is ready to accept a Bluetooth connection.

**NOTE** See the documentation included with the computer for information on how to prepare it to accept a Bluetooth connection. The documentation might refer to a Bluetooth connection as a Bluetooth pairing or a Bluetooth link.

e. Select the Device box.

**4**

Select the computer:

- a. When the Discovery Results screen appears, select your computer. If your computer does not appear on the list, select Find More.
- b. Select OK.

**5**

**[ & ] OPTIONAL** If prompted, enter a passkey:

- a. Enter a passkey number. This can be any number you choose; it does not have to be, for example, a password you use to access a network or an email account.



**[ ! ] IMPORTANT** You must enter the same passkey on your handheld and your computer in order to wirelessly synchronize with your computer. We recommend that you use a passkey of 16 digits where possible to improve the security of your handheld. The longer the passkey, the more difficult it is for the passkey to be deciphered.

- b. Select OK.

➤ **Continued**

## 6

Synchronize your handheld with your computer:

- a. **Go to Applications** and select HotSync .
- b. Make sure that Local is selected, and then select the connection you created in step 3 from the pick list.
- c. Tap the HotSync  icon onscreen.

↓ Done

**User Guide**

For everything you need to know about your handheld—all that's in this guide, and much more—go to [www.palm.com/TX-userguide](http://www.palm.com/TX-userguide).

**Tips & Tricks**

Make your handheld uniquely yours. For great tips, software, accessories, and more, visit [www.palm.com/myTX](http://www.palm.com/myTX).

**Support**

If you're having problems with your handheld's wireless capabilities or with anything else on your handheld, go to [www.palm.com/support](http://www.palm.com/support).

## Beyond the basics

Click the link to the *User Guide* on the web and learn about these related topics:

- |                  |   |
|------------------|---|
| <b>Wi-Fi</b>     | Configuring ad hoc connections to connect point-to-point with other devices enabled with Wi-Fi capability   |
| <b>Bluetooth</b> | <ul style="list-style-type: none"><li>• Connecting to the Internet through your Bluetooth desktop computer to access the web wirelessly</li><li>• Connecting to your Bluetooth phone by means of the infrared port on your handheld</li><li>• Setting the Bluetooth options on your handheld to allow your handheld to wake up and receive an incoming connection request when turned off</li></ul> |
| <b>Sharing</b>   | Sending information wirelessly using Bluetooth wireless technology on your handheld   |



# Your Email

## In this chapter

[Setting up an account](#)

[Getting and reading email](#)

[Sending an email message](#)

[Working with attachments](#)

[Working with Microsoft Exchange ActiveSync](#)

[Beyond the basics](#)

You already know how efficient email is for staying in touch with personal and business contacts. Now the VersaMail® application brings you a new level of convenience: email on the go. Enjoy the ease and speed of communicating with friends, family, and colleagues anywhere you can make an Internet connection.

You can email photos to your friends and family. Or use Documents on your handheld to create Microsoft Word or Excel files, and send them to your colleagues. You can also receive any of these file types as attachments to view and edit at your convenience.



## Benefits

- Access email on the go
- Send and receive photos, sound files, Word and Excel files, and more
- Save messages from your computer to view at a convenient time

## Setting up an account

**[ ! ] IMPORTANT** You must have an account with an email provider or a corporate account. VersaMail works with these accounts to transfer messages to and from your handheld. The application is not an email service provider.

Before you can use the VersaMail application with a given email account, you need to set up the account in VersaMail. You can do this in one of three ways:

- On a Windows computer, if the email account is already set up on your computer—for example, if you use Outlook Express on your computer to access your EarthLink account—you can transfer the account settings to your handheld in just a few steps.
- On a Windows computer, if this is a new account, you can quickly set up the account on your computer and **synchronize** the information to your handheld.
- If you are a Mac user, you can set up the account directly on your handheld. Windows users can also choose to set up either a new or existing account directly on the handheld.

**NOTE** Special setup considerations apply if you are setting up a **Microsoft Exchange ActiveSync® account** to synchronize email and Calendar information with Microsoft Exchange Server 2003.

## Setting up an account on your computer

### WINDOWS ONLY

The procedures for transferring settings from an existing account on your computer are the same as for setting up a new account, except for one step.

If you are setting up a new account and your email provider is not listed in the Mail Service list, follow the [full account setup instructions](#).

**1**

On your computer desktop, select Start, navigate to Programs, navigate to the Palm program group, and then select VersaMail Setup.

**2**

Select your username from the drop-down list at the top of the screen, and then select the option to create a new VersaMail email account. Click Next.

**3**

Select the setup option you want:

**Transfer settings from an existing account** Select the option to synchronize with an email account detected on your PC, and then select the account from the list at the top of the screen. Click Next.

**Set up a new account** Select the option to synchronize with a mail service from this list, and then select your mail service from the list. Click Next.

↘ **Continued**

- + **Did You Know?**  
If you are transferring existing account settings, your username and email address are already entered based on the account settings that the VersaMail application finds on your computer.

## 4

Enter the basic account information:

- Enter a descriptive name for the account, or use the one shown.
- Enter your account username and password. Your email address will be entered automatically based on the username you enter.



- Click Next.

## 5

Enter the names of the incoming and outgoing mail servers for this account, whether the account requires Extended Simple Mail Transfer Protocol (ESMTP), and, if so, the username and password required for ESMTP. Check with your email service provider for this information.

**NOTE** If you are using a common email provider, the mail server information is already filled in.

➤ **Continued**

6

Select whether to synchronize the information for this account to your handheld or to set up another account, and then click Next.

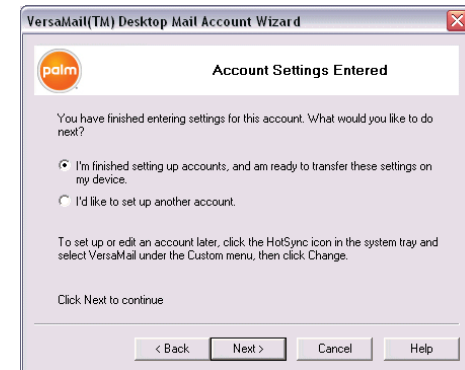

7

When you have finished setting up all accounts, click Finish.



8

**Synchronize** to transfer all account information to your handheld.

↓ Done

## Setting up an account on your handheld

Mac users must set up their VersaMail accounts on their handheld. Windows users can set up the account either on their handheld or on their computer. If you set up an account on your computer and synchronize the account information to your handheld, you do not need to set up the account on the handheld; it's already there.

**NOTE** Special setup considerations apply if you are setting up a **Microsoft Exchange ActiveSync® account** to synchronize email and Calendar information with Microsoft Exchange Server 2003.

**1**

Tap VersaMail  in the input area.

**2**

Open the Account Setup screen:

- a. **Open the menus**, select Accounts, and then select Account Setup.
- b. Select New.

↘ **Continued**

» **Key Term**

**Protocol** Settings your email provider uses to receive email messages. Most providers use the Post Office Protocol (POP); a few use the Internet Message Access Protocol (IMAP).

+ **Did You Know?**

Some service providers such as Yahoo! require you to pay for a POP account in order to download email messages from your account to your handheld.

+ **Did You Know?**

If your email provider appears on the Mail Service pick list, the Protocol pick list is not displayed.

**3**

Enter the basic account information:

- a. In the Account Name field, enter a descriptive name.

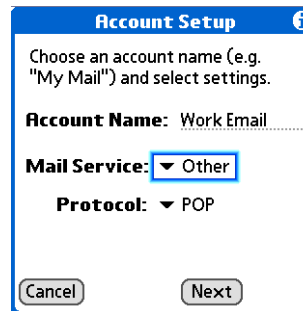

- b. Select the Mail Service pick list, and then select your email provider. Select Other if your provider is not listed.
- c. If you chose Other, select the Protocol pick list, and then select POP or IMAP.
- d. Select Next.

➤ **Continued**

\* **Tip**

Your username is usually the part of your email address appearing before the @ symbol, not your entire email address. Check with your ISP if you are not sure what username to enter.

+ **Did You Know?**

Your incoming mail server is also called your POP or IMAP server; your outgoing mail server is also called your Simple Mail Transfer Protocol (SMTP) server. Check with your email service provider if you need the names of these servers.

4

Enter the account username and password:

- Enter the username you use to access your email.
- Select the Password box, enter your email account password, and then select OK.
- Select Next.

5

Enter your email address and mail server info:

**NOTE** If you chose a common email provider from the Mail Services pick list on the Account Setup screen, this screen is already filled in.

- Enter your email address.
- Enter the names of your mail servers.
- Select Next.

6

Select Done.

↓ Done



+ **Did You Know?**  
You can set up your handheld to **automatically check for and download** new email messages.

\* **Tip**  
The first 5KB of each message is downloaded. You can **change the maximum size** for downloaded messages in the VersaMail preferences.

## Getting and reading email

**1** Tap VersaMail  in the input area.

**2** Retrieve messages:

- Open the menus.**
- Select Accounts, and then select the account you want.
- Select Get or Get & Send.

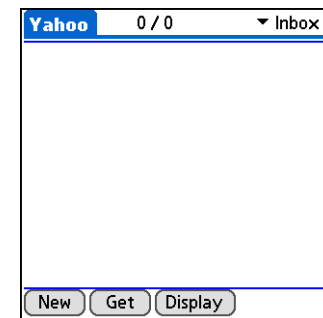

**3** In the Inbox, select the message to read it.

↓ Done

+ **Did You Know?**

When you put addresses in the copies (cc:) field, they are visible to all other recipients. Addresses in the blind copies (bcc:) field are hidden from all other recipients. Some account types do not support the bcc: field, so it may not appear.

+ **Did You Know?**

You can set up your handheld to **automatically continue to try and send messages** if the first attempt fails.

## Sending an email message

1

Tap VersaMail  in the input area.

2

Send email:

- a. **Open the menus**, select Accounts, and then select the account you want.
- b. Select New.

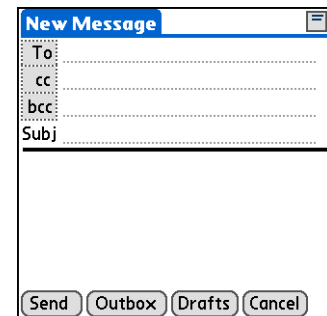
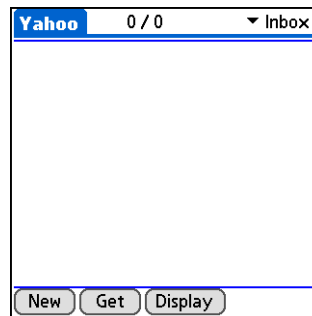

- c. In the To field, enter the recipient's email address. For multiple recipients, type a semicolon (;) between recipient names.
- d. In the Subj field, enter the subject of your email. In the area below the Subj line, enter the text of your email.
- e. Select Send.

↓ Done

**\* Tip**

If an attachment is not downloaded, the paper clip does not appear on the envelope icon. You need to open the message and download the complete message to see if there are any attachments.

**+ Did You Know?**

You can download a maximum of 10 attachments for any received messages.

## Working with attachments

You can easily download, view, save, and send attachments with email messages. Among the attachment types you can download and work with are Word docs, Excel spreadsheets, web pages, photos and videos, contacts, appointments, and tasks.

### Downloading an attachment to your handheld

In the message list, a paper clip on a message's envelope icon indicates that the message has an attachment that has been downloaded. You can view, edit, install, or save an attached file, depending on the file type.

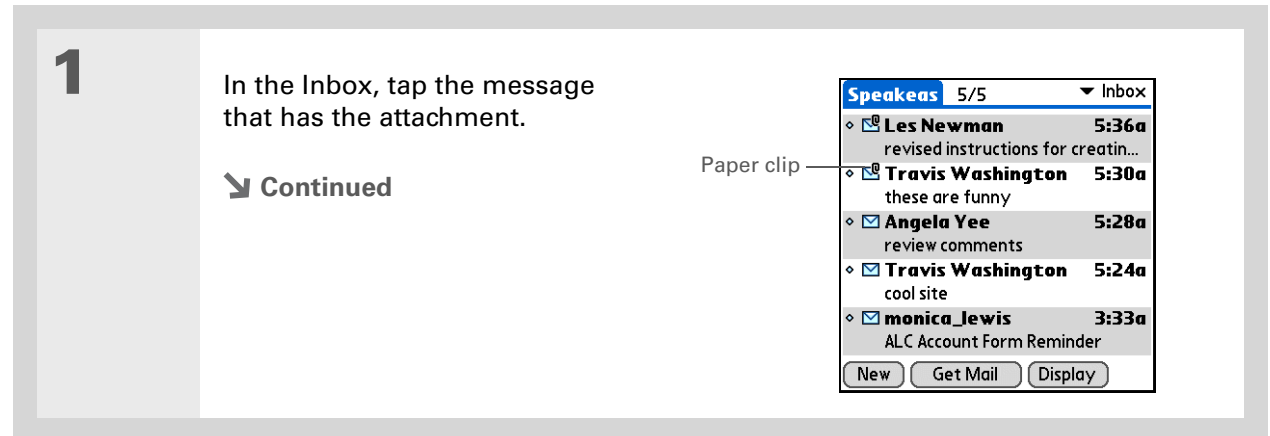

**+ Did You Know?**

The maximum message size you can download is 60KB for the body text and approximately 5MB total, including attachments. If an attachment is too large, it cannot be downloaded to the handheld.

**\* Tip**

The VersaMail application displays the size of large messages and asks if you want to continue downloading any message that exceeds your maximum message size, up to a total size of 5MB.

**2**

Select one of the following options for working with the downloaded attachment:

**Attachment name** Tap the attachment name at the bottom of the message screen to view it in the default viewer on your handheld.

**Folder icon** Tap the folder icon to the left of the attachment name to open a menu of tasks you can do with the attachment:

- View, Install, or Unzip, depending on the attachment file type
- Save to Card to save the attachment to an expansion card inserted in your handheld's expansion card slot
- Select Viewer to select the application you want to use to view the attachment

**3**

When you have finished with the attachment, select Done to return to the Attachments dialog box. If there is no Done button, press Home  and select VersaMail to return to the Inbox of the account you were using.

 Done

**+ Did You Know?**

The maximum size message you can send is 60KB for the body text and approximately 5MB of total data for any attachments. The maximum number of attachments for any email message is ten, regardless of the attachments' total size.

**Attaching a file from your handheld****1**

Open the Attachments screen:

- a. Create the message to which you want to attach the file.
- b. On the New Message screen, tap the red paper clip icon in the upper-right corner.

➤ **Continued**

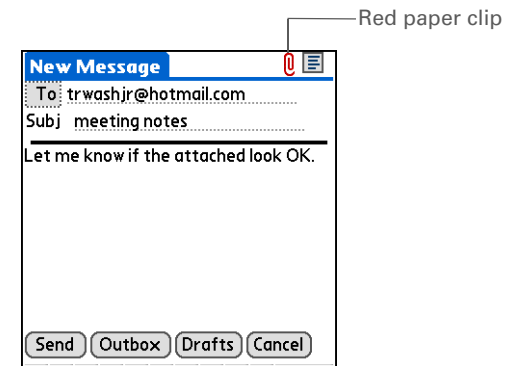

**\* Tip**

Repeat step 2 to attach more than one file to a message. To remove an attachment, select the file in the Attachments box, and then tap Delete.

**2**

Attach the file:

- a. Select the Type pick list, and then select the file type.

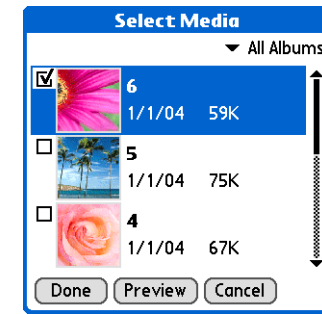
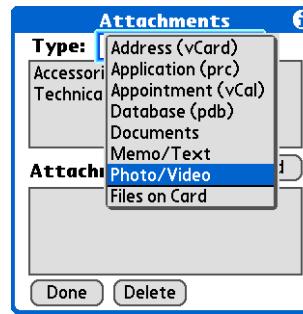

**NOTE** The Files on Card option appears only if an expansion card is inserted into your handheld's expansion card slot. Select it to display all files on the card in the upper box of the Attachments dialog box.

- b. Select the file that you want to attach, select Add or Attach, and then select Done. For photos and videos, check the box next to the items you want, and then select Done.

↓ Done

## Working with Microsoft Exchange ActiveSync

Microsoft Exchange ActiveSync works with the VersaMail and Calendar applications on your handheld to directly access corporate groupware information on a Microsoft Exchange 2003 server. You can access business email and calendar info on the Exchange 2003 server from your handheld without using a desktop computer.

When you create a Microsoft Exchange ActiveSync account in the VersaMail application, both your email and calendar info synchronize directly with the Exchange server; information does not synchronize with the desktop software application on your computer, such as Microsoft Outlook or Palm® Desktop software. Other information, such as contacts, tasks, and memos, continues to synchronize with your desktop software.

For most VersaMail features, using a Microsoft Exchange ActiveSync account works the same as using any other type of account. However, certain features—such as automatically retrieving and resending email messages and downloading attachments—work differently for Microsoft Exchange ActiveSync accounts. Also, the account setup procedure is slightly different for a Microsoft Exchange ActiveSync account. And, with a Microsoft Exchange ActiveSync account, you can receive and reply to meeting invitations directly from within the VersaMail application.

For complete information on using a Microsoft Exchange ActiveSync account, see the *[User Guide](#)* for your handheld on the web.

**User Guide**

For everything you need to know about your handheld—all that's in this guide, and much more—go to [www.palm.com/TX-userguide](http://www.palm.com/TX-userguide).

**Tips & Tricks**

Make your handheld uniquely yours. For great tips, software, accessories, and more, visit [www.palm.com/myTX](http://www.palm.com/myTX).

**Support**

If you're having problems with the VersaMail application or with anything else on your handheld, go to [www.palm.com/support](http://www.palm.com/support).

## Beyond the basics

Click the link to the *User Guide* on the web and learn about these related topics:

**Email**

- Using the VersaMail application with Microsoft Outlook® on your computer
- Setting basic email preferences such as changing the maximum message size, adding a signature to outgoing messages, and downloading files attached to email messages
- Using a virtual private network (VPN) to get and send email over your company's network
- Editing and deleting an email account
- Automatically retrieving email on your handheld
- Automatically trying to resend messages that weren't sent the first time
- Customizing your Inbox display options such as message summary view and font size and colors for read and unread mail
- Synchronizing email messages on your handheld with email messages on your computer

**Customizing**

Setting preferences for connecting to a network



# Your Text Messaging Tool

## In this chapter

[Sending a text message](#)

[Viewing a text message](#)

[Beyond the basics](#)

If you need to get a short message to a friend or co-worker fast, send a text message from your handheld by means of your mobile phone (GSM phone required; sold separately) to their mobile phone. Messaging is a popular way for people to stay connected using the text messaging features of their mobile phone.



## Benefits

- Enjoy quick communication
- Use text messaging to chat with friends

[ ! ] **Before You Begin**

**Set up a phone connection** on your handheld to send and receive information wirelessly.

» **Key Term**

**SMS** A type of message that can be received by most mobile phones. More commonly known as text messaging.

## Sending a text message

1

**Go to Applications** and select SMS .

2

Send a text message:

a. Select New.

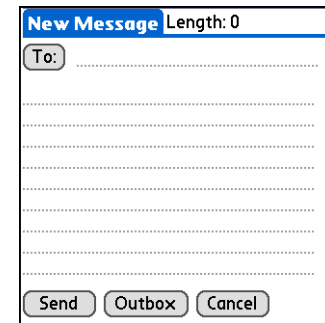
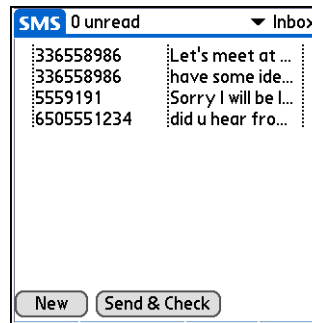

b. Select To. Select the recipient's name if it appears on the Mobile Number Lookup list, and then select Add. If the name does not appear on the list, select Cancel and enter the recipient's mobile phone number on the To line.

c. In the area below the To line, enter the text of your message.

d. Select Send.

 Done

**\* Tip**

Use the buttons at the bottom of the message screen to reply to or delete a message after you open it.

## Viewing a text message

**1**

**Go to Applications** and select SMS .

**2**

Select **Send & Check**.

**3**

Read a message:

a. Select the message to open it.

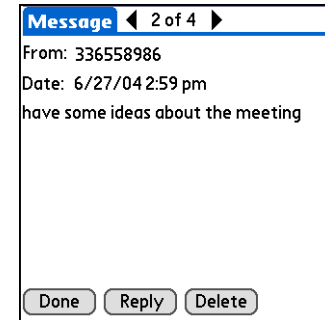
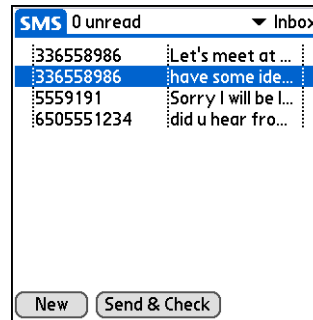

b. Read the message, and then select **Done**.

 **Done**

**User Guide**

For everything you need to know about your handheld—all that's in this guide, and much more—go to [www.palm.com/TX-userguide](http://www.palm.com/TX-userguide).

**Tips & Tricks**

Make your handheld uniquely yours. For great tips, software, accessories, and more, visit [www.palm.com/myTX](http://www.palm.com/myTX).

**Support**

If you're having problems with SMS or with anything else on your handheld, go to [www.palm.com/support](http://www.palm.com/support).

## Beyond the basics

Click the link to the *User Guide* on the web and learn about these related topics:

**SMS**

- Replying to and deleting messages you receive
- Setting preferences for receiving messages
- Hearing an alert when you receive a message

**Customizing**

Setting preferences for connecting to a network

# Your Web Browser

## In this chapter

[Accessing a web page](#)

[Beyond the basics](#)

You use the web for so many things: checking email, finding driving directions, getting news, buying gifts. Now you can take the web with you almost anywhere you go. Make an Internet connection through your mobile phone, and the web browser opens the entire web to you.



## Benefits

- Carry the web with you
- View web pages in a handheld-friendly format
- Store pages for offline viewing

**[ ! ] Before You Begin**

To browse the web, you must **set up a connection to the Internet** from your handheld.

**» Key Term**

**URL** Stands for “uniform resource locator,” the technical name for a web address. For example, the URL for Yahoo! is `http://www.yahoo.com`.

## Accessing a web page

**1**Press Web .**2**

Go to the web page you want to view:

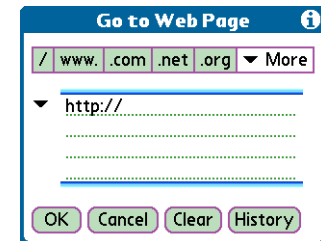
a. Select Go to Web Page .

b. Enter the address, or URL, of the web page you want to visit. Use the buttons in the Go to Web Page dialog box for quick entry of characters commonly used in web addresses. If you have previously visited a web page, the web browser recognizes the address when you begin entering it and automatically completes it.

c. Select OK.

 Done

### User Guide

For everything you need to know about your handheld—all that's in this guide, and much more—go to [www.palm.com/TX-userguide](http://www.palm.com/TX-userguide).

### Tips & Tricks

Make your handheld uniquely yours. For great tips, software, accessories, and more, visit [www.palm.com/myTX](http://www.palm.com/myTX).

### Support

If you're having problems with the web browser or with anything else on your handheld, go to [www.palm.com/support](http://www.palm.com/support).

## Beyond the basics

Click the link to the *User Guide* on the web and learn about these related topics:

### Web

- Enabling fast mode browsing
- Refreshing a page to see updated information
- Using a bookmark for quick access to your favorite web pages
- Returning to a web page you just visited or to your home page
- Downloading a file from a web page
- Changing your start and home pages

### Customizing

Setting preferences for connecting to a network

**NOTE** This is a sample Note inserted for the purposes of this test.

# Your Expandable Storage

## In this chapter

[What type of expansion cards can I use?](#)

[How can expansion cards help me?](#)

[Removing an expansion card](#)

[Inserting an expansion card](#)

[Beyond the basics](#)

A Chinese proverb says, “Life just gives you time and space; it’s up to you to fill it.” But doesn’t it always seem that no matter how much space you have, you still need more?

Expansion cards (sold separately) provide a compact and limitless answer to the storage dilemma. When one card becomes full, simply use another card. Also use expansion cards to install and run cool games and other types of software, from dictionaries to travel guides, on your handheld.



## Benefits

- Back up info
- Add more games and other software
- Add accessories
- Store all your info



**» Key Term**

**SDIO** An acronym for Secure Digital input/output.

## What type of expansion cards can I use?

Your handheld is compatible with SDIO, SD, and MultiMediaCard expansion cards. SDIO expansion cards let you add accessories to your handheld. SD and MultiMediaCard expansion cards let you store information and applications.

## How can expansion cards help me?

**Back up info.** Make a copy of your important information for safekeeping in case your handheld becomes damaged or is stolen.

**Add games and other software.** Purchase popular games, dictionaries, travel guides, and more. To check out the variety of expansion cards available for your handheld, visit [www.palm.com/myTX](http://www.palm.com/myTX) and click the Accessories link.

**Add accessories.** Attach SDIO accessories, such as a presentation module, to your handheld.

**Store all your info.** Never worry about running out of space on your handheld. Purchase as many expansion cards as you need to store your music, photos, videos, and other information. Expansion cards come in a variety of capacities, and they're very small, easy to store, and affordably priced.

**NOTE** Mac users must copy music files from your computer to an expansion card inserted into your handheld's expansion card slot in order to listen to music on your handheld.

- \* **Tip**  
To prevent damaging the card and the info on it, always wait for your handheld to finish writing to the expansion card before you remove the card from the slot.

## Removing an expansion card

**NOTE** Your handheld comes with a dummy card inserted into the expansion card slot. You must remove this card before you can put a real card into the slot.

**1**

Push lightly against the card with your thumb until you hear the confirmation tone.

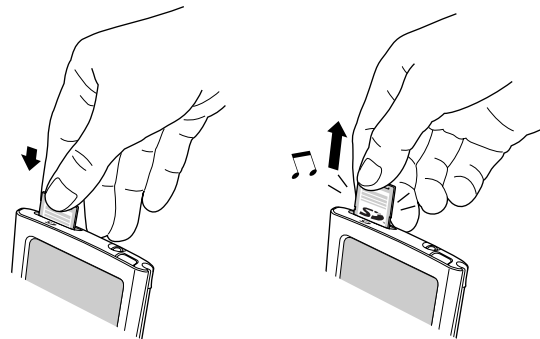
**2**

Slide the card out of the expansion slot.

↓ Done

## Inserting an expansion card

**1**

Insert the card into the expansion slot with the label side facing the front of the handheld.

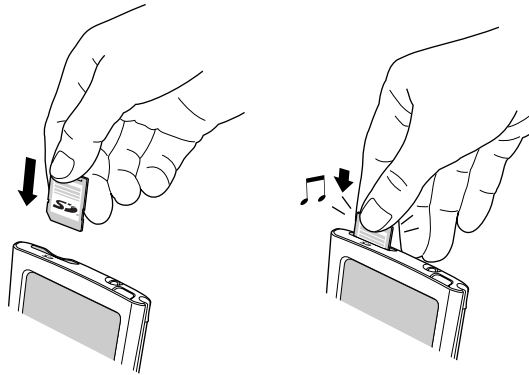
**2**

Push the card in with your thumb until you feel the card “click” into place and you hear the confirmation tone.

**NOTE** No confirmation tone? Check the [Sounds & Alerts Preferences](#) to make sure the System Sound setting is turned on.

↓ Done

**User Guide**

For everything you need to know about your handheld—all that's in this guide, and much more—go to [www.palm.com/TX-userguide](http://www.palm.com/TX-userguide).

**Tips & Tricks**

Make your handheld uniquely yours. For great tips, software, accessories, and more, visit [www.palm.com/myTX](http://www.palm.com/myTX).

**Support**

If you're having problems with expansion cards or with anything else on your handheld, go to [www.palm.com/support](http://www.palm.com/support).

## Beyond the basics

Click the link to the *User Guide* on the web and learn about these related topics:

**Expansion Cards**

- Opening applications that are stored on expansion cards
- Copying applications between your handheld and an expansion card
- Deleting applications and other files from an expansion card
- Reviewing information about the contents of an expansion card using the Card Info application
- Naming an expansion card so you can easily identify its contents

**Moving Info**

Adding applications from your computer to an expansion card, and installing other files such as music

**Sharing**

- Exchanging applications and information with other Palm Powered™ devices by exchanging cards or beaming items
- Sending applications and information to other Bluetooth® devices using Bluetooth wireless technology on your handheld

# Your Personal Settings

## In this chapter

[Changing entries in Favorites](#)

[Conserving battery power](#)

[Preventing your handheld  
from turning on by accident](#)

[Setting the date and time](#)

[Changing the screen fonts](#)

[Changing the background of  
your screen](#)

[Correcting problems with  
tapping](#)

[Selecting sound settings](#)

[Beyond the basics](#)

Although customizing your handheld is optional, it's like changing the preset radio stations in your car. Since you're probably not driving around with the dealer's preset radio stations, why not personalize your handheld, too?

You can easily customize the sound levels, fonts, and screen colors on your handheld by using preferences and menus. And preference settings can help extend the life of your handheld's battery.



## Benefits

- Access applications quickly
- Make your screen easy to read
- Conserve power
- Enjoy your handheld more

- + **Did You Know?**  
You can move a favorite to a different location on the Favorites list by opening the Favorite menu and then selecting Rearrange Favorites. Drag the favorite you want to the new location.

## Changing entries in Favorites

Change the entries in the Favorites View to include the applications or web links you use most often.

**1**

Open the Edit Favorites dialog box:

- Press Home  to open Favorites.
- Highlight the favorite you want to change.
- Open the menus.**
- Select Edit Favorites.

**2**

Change the favorite:

- Select the favorite type from the Type pick list: App (application) or Web Link.
- Select the application from the Original pick list or tap to enter the web address you want.
- Enter a name for your new favorite.
- Select OK.

 Done

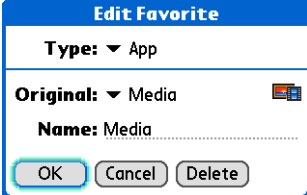

**Edit Favorite**

Type: ▼ App

Original: ▼ Media 

Name: Media

OK Cancel Delete

\* **Tip**

When Keylock is on, your handheld does not respond when you press the buttons on the front of your handheld. To use your handheld again, press the power button and then tap Deactivate Keylock.

+ **Did You Know?**

You can use **Owner Preferences** to enter your name, address, and phone number. If you also turn on **Security settings**, your Owner info appears when you turn on your handheld. This could help someone contact you if you ever lose your handheld.

## Preventing your handheld from turning on by accident

Does your handheld turn itself on accidentally in your briefcase, pocket, or purse? You can lock the buttons on the front of your handheld so you prevent this from happening and don't drain the battery.

1

Open Keylock Preferences:

- a. **Go to Applications.**
- b. Select Prefs .
- c. Select Keylock.

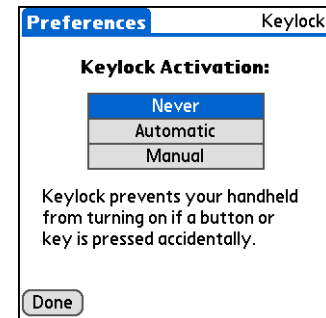

2

Select one of these settings, and then select Done.

**Never** Keylock always remains off.

**Automatic** Keylock turns on automatically when you turn off your handheld or when your handheld goes to sleep.

**Manual** Keylock turns on when you hold down the power button until the system sound confirms that Keylock is on.

↓ Done

**+ Did You Know?**

If you have an expansion card inserted into your handheld's expansion card slot, the System info screen shows the available memory for both your handheld and the card. The graphic labeled "Device" with the larger memory size is your handheld, while the graphic with the smaller memory size is the card.

## Conserving battery power

You can conserve your handheld's battery power by reducing screen brightness or customizing the power settings.

### Adjusting the brightness

**1**

Tap System info **12:55**, which shows the current time, on the status bar.

**2**

Drag the slider to adjust the brightness level, and then tap outside the dialog box.

↓ Done

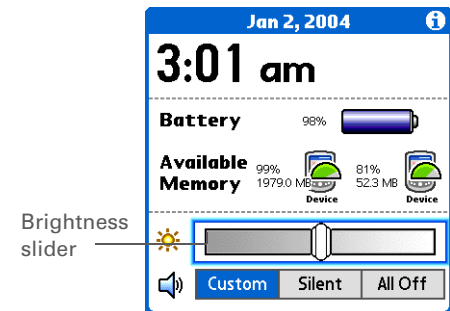



## Selecting power-saving settings

The Power Preferences screen enables you to set power consumption options.

**1**

Open Power Preferences:

- a. **Go to Applications.**
- b. Select Prefs .
- c. Select Power.

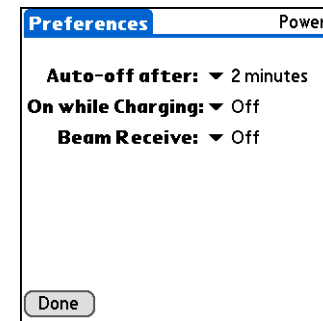
**2**

Select the pick lists to change any of the following settings, and then select Done.

**Auto-off after** Select how quickly your handheld automatically turns off after a period of inactivity: 30 seconds, 1 minute, 2 minutes, or 3 minutes.

**On while Charging** Select whether your handheld stays on continuously when it is connected to the AC charger. When this option is off, you can still turn on your handheld while it charges to view your info, but it turns off automatically after a period of inactivity.

**Beam Receive** Select whether you can receive beamed information on your handheld. Turn this setting on to receive beamed info, or turn it off to prevent receiving beamed info.

↓ Done

\* **Tip**

You can rename the location to the city where you live. Select the Name field, and then modify the location name.

## Setting the date and time

You can set the current date and time based on your location. These settings are used by all the applications on your handheld that require a date, time, or location.

### 1

Open Date & Time Preferences:

- a. **Go to Applications.**
- b. Select Prefs .
- c. Select Date & Time.

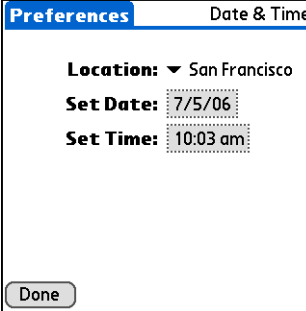

**Preferences** Date & Time

**Location:** San Francisco

**Set Date:** 7/5/06

**Set Time:** 10:03 am

Done

### 2

Select the location:

- a. Select the Location pick list, and select a city in your time zone. No nearby city? Select Edit List and do steps b and c.
- b. Select Add.
- c. Select a city in your time zone, and then select OK. Select OK again, and then select Done.



**Edit Location** ⓘ

**Name:** Bonny Doon

**Time Zone:** USA (Pacific)

**This location observes Daylight Saving Time**

**Start:** First Sunday of April

**End:** Last Sunday of October

OK Cancel

↘ **Continued**

## 3

Set the date:

- Select the Set Date box.
- Select the arrows to select the current year.
- Select the current month.
- Select the current date.

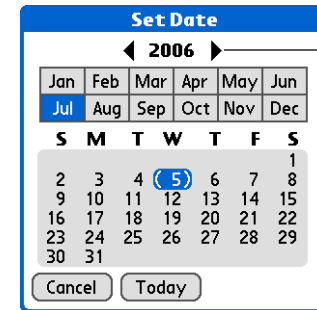

Year  
arrows

## 4

Set the time:

- Select the Set Time box.
- Select the hour and minute boxes, and then tap the arrows to change them.
- Select AM or PM, and then select OK.

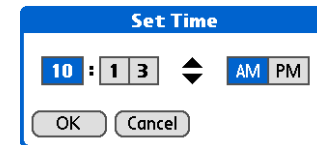

## 5

Select Done.

↓ Done

## Changing the screen fonts

In many applications, you can change the font style to make text easier to read. There are four font styles available in applications that let you change the font style.

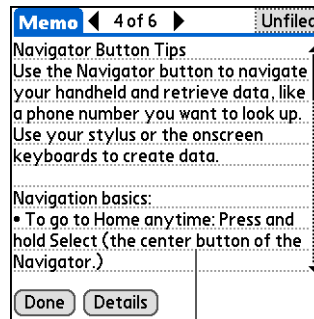

Small font

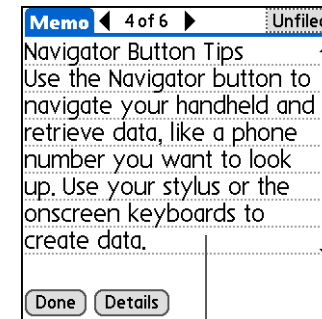

Large font

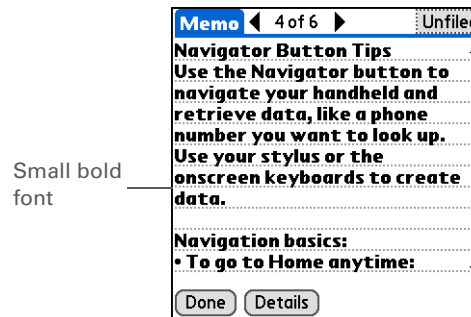

Small bold font

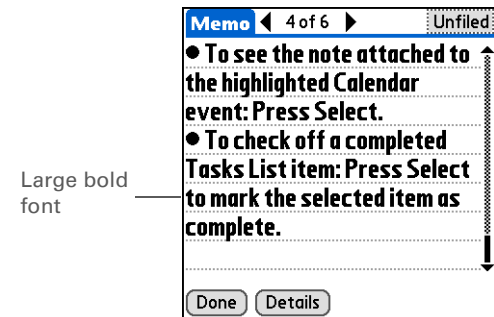

Large bold font

**1**

Open the Select Font dialog box:

- a. **Go to Applications.**
- b. **Open the menus.**
- c. Select Options, and then select Font.

**2**

Select the font style you want to use, and then select OK.

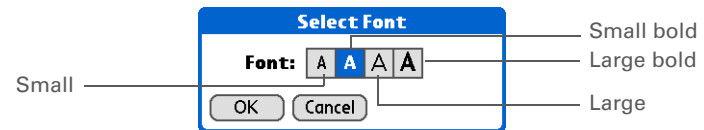



↓ Done

## Changing the background of your screen

Use your favorite photos as the background for the Favorites and Applications Views and the Agenda View in Calendar. Choose the same photo for all screens or make them different.

### 1

Open the Display Options dialog box:

- Press Home  once for Favorites, twice for Applications. Or press Calendar  for Agenda View.
- Open the menus.**
- Select Options, and then select Display Options. For Favorites, select Options, and then select Preferences.

### 2

Select a photo:

- Check the Background box.
- Tap the photo thumbnail and select a photo.
- Adjust the fade setting so that text and icons are easy to see against the photo.
- Select OK.

↓ Done

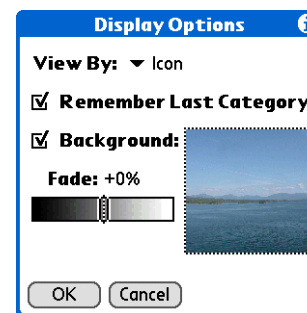

**NOTE** The dialog box for selecting a background photo appears differently in each of the three applications. The Applications Display Options dialog box is shown here.

## » Key Term

**Touchscreen** Another name for your handheld's screen and its internal circuitry.

## \* Tip

If your screen is not responding to taps, use the 5-way navigator to open Touchscreen Preferences.

## Correcting problems with tapping

Is your screen not responding to taps? Are you getting unexpected results when you tap? For example, when you tap the number keyboard icon, does the Wi-Fi® dialog box open instead? If this happens, it's time to align the screen.

**1**

Open Touchscreen Preferences:

- a. **Go to Applications.**
- b. Select Prefs .
- c. Select Touchscreen.

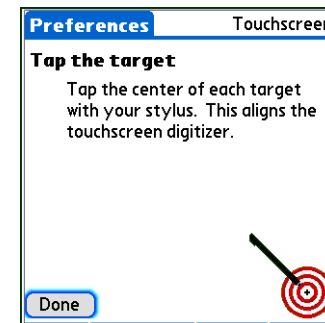
**2**

Tap the targets on the screen as precisely as possible, and then select Done.

**NOTE** You need to tap at least three targets—maybe more if you don't tap carefully.

↓ Done

\* **Tip**  
You can choose different types of sounds for Calendar, Tasks, and World Clock. Go to the application, **open the Options menu**, and then select Preferences.

+ **Did You Know?**  
Curtain going up? The quickest way to turn off all sounds coming from your handheld is to tap System information on the status bar and select Silent.

## Selecting sound settings

Are sounds too soft or too loud? Set the volume levels for the system, game, and alarm tones, or turn sounds off altogether with the Silent profile.

### 1

Open Sounds & Alerts Preferences:

- a. **Go to Applications.**
- b. Select Prefs .
- c. Select Sounds & Alerts.

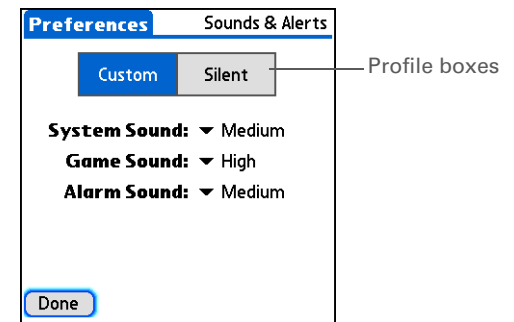

### 2

Select Custom or Silent.

### 3

If you selected Silent in step 2, select Done.

If you selected Custom in step 2, tap the System Sound, Game Sound, and Alarm Sound pick lists and select the volume level for each sound; then select Done.

↓ Done



**User Guide**

For everything you need to know about your handheld—all that's in this guide, and much more—go to [www.palm.com/TX-userguide](http://www.palm.com/TX-userguide).

**Tips & Tricks**

Make your handheld uniquely yours. For great tips, software, accessories, and more, visit [www.palm.com/myTX](http://www.palm.com/myTX).

**Support**

If you're having problems with customization or with anything else on your handheld, go to [www.palm.com/support](http://www.palm.com/support).

## Beyond the basics

Click the link to the *User Guide* on the web and learn about these related topics:

**Customizing**

- Choosing formats for times, dates, calendar, and numbers based on a geographical region
- Selecting options for entering text, such as choosing how to enter certain Graffiti® 2 characters and using the full screen as the writing area
- Helping someone who has found your lost handheld identify its owner by entering information that identifies you as the owner
- Configuring communication connections and network settings

**Privacy**

Keeping information private by turning on security options

# Common Questions

\* **Tip**  
During the transfer process, you can select which information to transfer from the old software to the new software.

Although we can't anticipate all the questions you might have, this chapter provides answers to some of the most commonly asked questions.

## How do I upgrade from another Palm Powered™ device?

1. Synchronize your old handheld with your old desktop software.
2. Install the new Palm® Desktop software. There's no need to delete the old desktop software first.
3. Select the username you assigned to your old handheld during the desktop installation. This will transfer your information from the old software to the new software.
4. Synchronize your new handheld with your new desktop software.
5. If any third-party applications do not transfer to your new handheld, reinstall them.
6. If you have problems with your third-party applications on your new handheld, you'll have to update them. If any of the following symptoms occur on your new handheld after you synchronize, remove the third-party applications and contact the vendor for updated versions:
  - Handheld freezes or resets when you open an application
  - Slow performance
  - Unusual screen display
  - Difficulties using handheld features
  - Uneven sound quality

### Why can't I find an icon in Applications View?

- Tap the category pick list in the upper-right corner of the Applications View screen and select All. You may need to scroll down a bit, but you should now see an icon for each of the applications on your handheld—except the wireless applications, Wi-Fi® and Bluetooth®, which you need to access from the status bar.
- Some of the applications that come with your handheld are not preinstalled. You need to **install these extra applications from your software installation CD.**

### How do I save my info?

Each time you complete an entry such as a contact, memo, or note, your handheld automatically saves the information you entered. You don't have to do anything special to save your info. To protect your info and create a backup of your info, we recommend that you synchronize your handheld with your computer often.

### How do I know when I need to recharge my handheld?

A battery icon  appears at the top of the Favorites and Applications screens. Check the gauge periodically to see if your handheld needs to be recharged. If the battery becomes low, a message appears on the screen prompting you to recharge the battery.

### Will I lose all my information if the battery becomes drained?

The memory on your handheld is designed to store your information even if the battery becomes drained to the point that you cannot turn on your handheld. When you recharge your handheld, all of your existing information will appear.

### What do I do if pressing the Home button opens something else besides Favorites?

If the input area does not display the Home icon, tap and hold one of the icons in the input area, and then select Launcher (Applications View) from the list. Tap the Home icon to open Applications, and then select Prefs. Select Buttons, select the pick list next to the Home icon, and then select Favorites. Pressing the Home button will now open Favorites.

\* **Tip**

Need more help with synchronizing your handheld? Open Palm Desktop software, go to the Help menu, and then select HotSync Online Troubleshooting Guide.

## How often should I recharge my handheld?

We recommend that you recharge your handheld for at least half an hour every day. Ideally, connect your handheld to a power source every night and recharge it while you sleep. Also, you can conserve battery life by doing any of the following:

- **Adjust the screen brightness**
- **Reduce the Auto-off setting**
- **Use Keylock to prevent your handheld from turning on by accident**
- Stop **music** or **video** playback when not in use
- **Respond to or cancel alerts promptly**
- **Turn off Bluetooth® wireless technology and Wi-Fi® functionality** when not in use
- **Minimize use of the expansion slot**

## What do I do if I can't synchronize with my computer?

Make sure the USB sync cable is connected securely.

### WINDOWS ONLY

- Click the HotSync® Manager  icon in the Windows taskbar in the lower-right corner of your screen. Make sure that Local USB has a checkmark next to it. If not, click it.



- If you don't see the HotSync Manager icon, click Start on the Windows taskbar, and then select Programs. Go to the Palm program group and select HotSync Manager. Click the HotSync Manager icon when it appears in the system tray. Make sure that Local USB is selected.

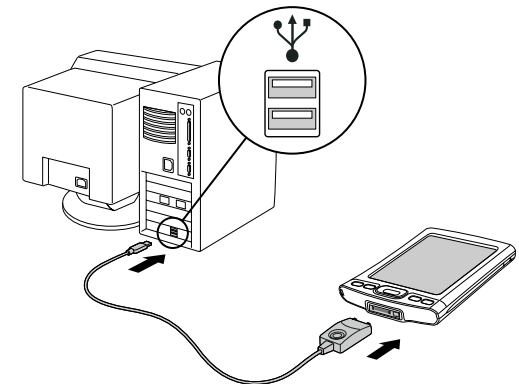

**[ ! ] Before You Begin**

You must have completed CD installation and chosen Palm Desktop software as your desktop application for synchronization in order to switch to Outlook.

Note that you can choose Outlook as your synchronization software for Contacts, Calendar, Tasks, and Memos during CD installation.

**MAC ONLY**

- Make sure that HotSync Manager is enabled: Open the Palm folder and double-click the HotSync Manager icon. On the HotSync Controls tab, be sure Enabled is selected. If it is not, click it. On the Connection Settings tab, make sure that USB has a checkmark next to it.
- Disconnect the USB sync cable from your computer, and then reconnect the cable and restart your computer.

**How do I change from synchronizing with Palm® Desktop software to synchronizing with Outlook?****WINDOWS ONLY**

During CD installation, you chose a desktop software application to synchronize with your handheld. You may have chosen Palm Desktop software at that time. But if Microsoft Outlook already contains all of your contacts, appointments, tasks, and notes, you can change your synchronization method so that your handheld synchronizes with Outlook instead. You can also change from Outlook to Palm Desktop software.

**NOTE** If you choose to synchronize with Outlook, info from Contacts, Calendar, Tasks, and Memos is synchronized with info in the corresponding application in Outlook. (Memos is called Notes in Outlook.) You can also set up the VersaMail® application to synchronize with Outlook. Other info, such as photos and notes, is synchronized with info in the corresponding application in Palm Desktop software.

1. Insert the CD into your computer.
2. Select Change your synchronization method.
3. Follow the onscreen instructions for the desktop software you want to use.

**What do I do if my handheld doesn't respond to taps correctly?**

If your handheld is not responding to taps correctly, you need to **align the screen**.

\* **Tip**  
After a soft reset, the Preferences screen appears with the Date & Time option highlighted so you can reset the date and time if necessary.

## What do I do if my handheld is not responding?

On rare occasions your handheld may not respond to tapping or pressing of buttons. If this happens, first check that **Keylock** is not turned on.

If Keylock is off and your handheld is still not responding, you need to reset your handheld. A soft reset tells your handheld to stop and start over again. This does not affect any of the information or applications on your handheld.

Use the tip of the stylus to gently press the reset button on the back of your handheld.

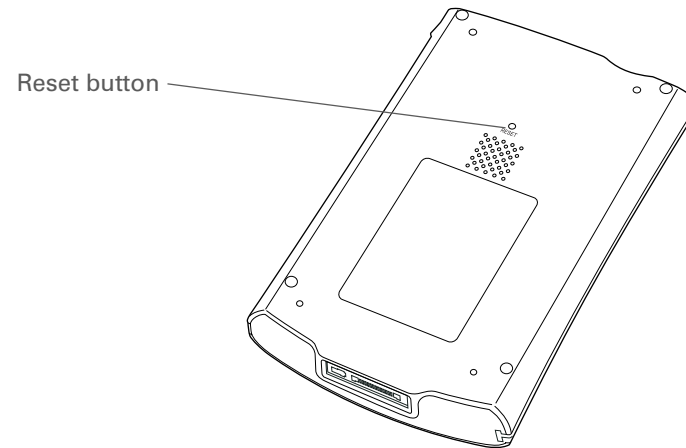

If a soft reset does not unfreeze your handheld, you need to perform a hard reset. For instructions, see the *User Guide* on the web.

## Can I open my handheld?

No, do not open your handheld; there are no user-serviceable parts inside. Opening your handheld voids the warranty and is not recommended under any circumstances.

**User Guide**

For everything you need to know about your handheld—all that's in this guide, and much more—go to [www.palm.com/TX-userguide](http://www.palm.com/TX-userguide).

**Tips & Tricks**

Make your handheld uniquely yours. For great tips, software, accessories, and more, visit [www.palm.com/myTX](http://www.palm.com/myTX).

**Support**

If you're having problems with your handheld, go to [www.palm.com/support](http://www.palm.com/support).

## Beyond the basics

Click the link to the *User Guide* on the web and learn about these related topics:

**Common Questions**

- Troubleshooting software installation problems
- Solving problems with specific applications
- Troubleshooting synchronization problems
- Solving problems with beaming and communication settings

**Maintaining**

Performing a hard reset if a soft reset does not unfreeze your handheld

# Product Regulatory Information

## FCC Statement

This device complies with part 15 of the FCC rules. Operation is subject to the following two conditions: (1) This device may not cause harmful interference, and (2) this device must accept any interference received, including interference that may cause undesired operation.

This equipment has been tested and found to comply with the limits for a Class B digital device, pursuant to Part 15 of the FCC rules. These limits are designed to provide reasonable protection against harmful interference in a residential installation. This equipment generates, uses, and can radiate radio frequency energy and, if not installed and used in accordance with the instructions, may cause harmful interference to radio communications. However, there is no guarantee that interference will not occur in a particular installation. If this equipment does cause harmful interference to radio or television reception, which can be determined by turning the equipment off and on, the user is encouraged to try to correct the interference by one or more of the following measures:

- Reorient or relocate the receiving antenna.
- Increase the separation between the equipment and receiver.
- Connect the equipment into an outlet on a circuit different from that to which the receiver is connected.
- Consult the dealer or an experienced radio/TV technician for help.

The use of shielded I/O cables is required when connecting this equipment to any and all optional peripheral or host devices. Failure to do so may violate FCC rules.

**[ ! ] IMPORTANT** Changes or modifications not covered in this manual must be approved in writing by the manufacturer's Regulatory Engineering Department. Changes or modifications made without written approval may void the user's authority to operate this equipment.

In August 1996, the FCC of the United States with its action in Report and Order FCC 96-326 adopted an updated safety standard for human exposure to radio frequency electromagnetic energy emitted by FCC regulated transmitters. Those guidelines are consistent with the safety standard previously set by both U.S. and international standards bodies. The design of this product complies with the FCC guidelines and these international standards.



## Exposure to radio frequency energy (SAR)

In order to comply with FCC RF exposure safety guidelines, this device and its antenna must not be co-located or operating in conjunction with any other antenna or transmitter. The user of this device should ensure that the operation of this device is in compliance with these provisions.

FCC ID: O8FAOKI

### Responsible Party:

Palm, Inc.  
950 W. Maude Ave.  
Sunnyvale, California 94085-2801  
United States of America  
(408) 617-7000



## Industry Canada

The term "IC:" before the certification/registration number only signifies that the Industry Canada technical specifications were met.

IC: 3905A-AOKI

## Canadian Wireless Regulatory Notice

This Class B digital apparatus meets all the requirements of the Canadian Interference Causing Equipment Regulations. Operation is subject to the following two conditions: a) this device may not cause any interference, and b) this device must accept any interference, including interference that may cause undesired operation of the device. To prevent radio interference to the licensed service, this device is intended to be operated indoors, and away from windows to prevent maximum shielding. Equipment (or its transmit antenna) that is installed outdoors is subject to licensing.



## CE Declaration of Conformity

<b>Palm, Inc., Declares the Product:</b>	Handheld PDA & HotSync® cable
<b>Model Name/Number:</b>	T X
<b>Manufacturer's Name:</b>	Palm
<b>Manufacturer's Address:</b>	950 W. Maude Ave. Sunnyvale, California 94085-2801

Meets the following European Council Directives:

- 89/336/EEC (EMC Directive)
- 99/5/EC (R&TTE Directive)
- 73/23/EEC (Low Voltage Directive).

Conforms with the following specifications:

- EN 55024: 1998 (Emissions & Immunity)
- EN55022:1998, CISPR 22 1997, Class B Radiated and Conducted Emissions
- EN 300-328V1.5.1 (2004-08)
- EN 59005: 1998
- EN 50392: 2004

**Authorized Palm Representative:** Palm Regulatory Compliance Department

**Date:** June 23, 2005

## Battery Warning

Do not mutilate, puncture, or dispose of batteries in fire. The batteries can burst or explode, releasing hazardous chemicals. Discard used batteries according to the manufacturer's instructions and in accordance with your local regulations.

### Varning

Eksplodingsfara vid felaktigt batteribyte. Använd samma batterityp eller en ekvivalent typ som rekommenderas av apparattillverkaren. Kassera använt batteri enligt fabrikantens instruktion.

### Advarsel!

Lithiumbatteri—Eksplodingsfare ved fejlagtig håndtering. Udskiftning må kun ske med batteri af samme fabrikat og type. Levér det brugte batteri tilbage tilleverandøren.

### Varoitus

Paristo voi räjähtää, jos se on virheellisesti asennettu. Vaihda paristo ainoastaan valmistajan suosittelemaan tyyppiin. Hävitä käytetty paristo valmistajan ohjeiden mukaisesti.

### Advarsel

Eksplodingsfare ved feilaktig skifte av batteri. Benytt samme batteritype eller en tilsvarende type anbefait av apparatfabrikanten. Brukte batterier kasseres i henhold til fabrikantens instruksjoner.

### **Waarschuwing!**

Bij dit produkt zijn batterijen geleverd. Wanneer deze leeg zijn, moet u ze niet weggooien maar inleveren als KCA.

### **Uwaga**

Nie kroić lub przekłuwać baterii, ani nie wrzucać ich do ognia. Mogą się rozerwać lub wybuchnąć wydzielając trujące środki chemiczne. Zużytych baterii należy pozbywać się w sposób opisany przez producenta i zgodnie z miejscowymi przepisami.

אזהרה  
יש סכנת התפוצצות אם מחליפים את הסוללה בצורה לא נכונה.  
יש להחליף את הסוללה בסוללה זזה או דומה, בהתאם להמלצת היצרן.  
יש להשליך סוללות משומשות בהתאם להוראות היצרן

## **Intrinsic Safety Warning**

### **Warning – Explosion Hazard**

- Substitution of components may impair suitability for Class I, Division 2;
- When in hazardous location, turn off power before replacing or wiring modules, and,
- Do not disconnect equipment unless power has been switched off or the area is known to be non-hazardous.

## **Wireless Notices— Usage Cautions**

In some situations, the user of the wireless device may be restricted. Such restrictions may apply aboard an airplane, in hospitals, near explosive environment, in hazardous locations etc. If you are not certain of the policy that applies to the use of this device, please ask for authorization prior to turning on the device.

## **Static Electricity, ESD, and Your Palm<sup>®</sup> Handheld**

Electrostatic discharge (ESD) can cause damage to electronic devices if discharged into the device, so you should take steps to avoid such an occurrence.

### **Description of ESD**

Static electricity is an electrical charge caused by the buildup of excess electrons on the surface of a material. To most people, static electricity and ESD are nothing more than annoyances. For example, after walking over a carpet while scuffing your feet, building up electrons on your body, you may get a shock—the discharge event—when you touch a metal doorknob. This little shock discharges the built-up static electricity.

### **ESD-susceptible equipment**

Even a small amount of ESD can harm circuitry, so when working with electronic devices, take measures to help protect your electronic devices, including your Palm® handheld, from ESD harm. While Palm has built protections against ESD into its products, ESD unfortunately exists and, unless neutralized, could build up to levels that could harm your equipment. Any electronic device that contains an external entry point for plugging in anything from cables to docking stations is susceptible to entry of ESD. Devices that you carry with you, such as your handheld, build up ESD in a unique way because the static electricity that may have built up on your body is automatically passed to the device. Then, when the device is connected to another device such as a docking station, a discharge event can occur.

### **Precautions against ESD**

Make sure to discharge any built-up static electricity from yourself and your electronic devices *before* touching an electronic device or connecting one device to another. The recommendation from Palm is that you take this precaution before connecting your handheld to your computer, placing the handheld in a cradle, or connecting it to any other device. You can do this in many ways, including the following:

- Ground yourself when you're holding your mobile device by simultaneously touching a metal surface that is at earth ground. For example, if your computer has a metal case and is plugged into a standard three-prong grounded outlet, touching the case should discharge the ESD on your body.
- Increase the relative humidity of your environment.
- Install ESD-specific prevention items, such as grounding mats.



### **Conditions that enhance ESD occurrences**

Conditions that can contribute to the buildup of static electricity in the environment include the following:

- Low relative humidity.
- Material type (The type of material gathering the charge. For example, synthetics are more prone to static buildup than natural fibers like cotton.)
- The rapidity with which you touch, connect, or disconnect electronic devices.

While you should always take appropriate precautions to discharge static electricity, if you are in an environment where you notice ESD events, you may want to take extra precautions to protect your electronic equipment against ESD.

**SYMBOLS**

- \* (asterisk) characters 64
- ; (semicolon) characters 113

**NUMERICS**

- 5-way navigator 3, 16
  - scrolling application categories 15

**A**

- AC charger 25
- accessing
  - applications 146
  - email accounts 8, 91, 95, 97, 101
  - information 16
  - web pages 125, 126
  - websites 84, 91, 97, 124
- accessories 28, 45, 57, 61, 75, 82, 119, 128, 150
- Account Setup screen 109
- adding
  - applications 30
  - contacts 64, 66
  - email messages 113
  - events 68
  - expansion cards 128
  - memos 77, 78, 79
  - notes 80
  - other software 128
  - reminders 65
  - tasks 63, 72
- Addit software 9
- add-on applications 145
- addresses 4
  - See also* contacts
- addressing
  - email 75, 113
  - text messages 121
- adjusting speaker volume 143
- Adobe Acrobat Reader 7
- agenda lists 63
  - See also* Calendar application
- Agenda View (Calendar) 70
- alarm clock 71
- Alarm Sound pick list 143
- alarms
  - See also* reminders
  - adjusting volume for 143
  - icon on status bar 12
  - incoming messages and 123
  - selecting sounds for 71, 75
  - setting 71, 72, 82
- albums
  - additional information for 45
  - creating 41
  - moving photos in 43
  - moving videos in 43
- alerts 27
  - icon on status bar 12
- alerts *See* alarms
- aligning screen 142
- anniversaries 69
- application buttons, location of 3
- application icons 146
- applications
  - See also* specific built-in application
  - accessing 146
  - additional information for 28, 131
  - copying 131
  - deleting 28, 131
  - exchanging 28, 131

- installing 6, 30
  - not finding 7
  - setting local preferences for 137
  - soft resets and 149
  - storing on expansion cards 131
  - switching between 148
  - transferring third-party 145
  - transferring to handheld 10
  - troubleshooting 146, 150
- Applications View
  - adding background to 141
  - displaying icons on 146
  - opening applications in 15
  - using 15
- appointments
  - See also* Calendar application; events
  - color-coding 69
  - combining tasks with 63
  - entering from Outlook 148
  - filing 69
  - scheduling 68–69
  - setting duration of 69
  - sharing 4
- ASF media files 37
- asterisk (\*) characters 64
- attachments
  - downloading 114
  - sending events as 75, 82
  - sending files as 116, 117
  - sending multimedia files as 45
- Attachments screen 116
- Audible Player software 7
- audio
  - applications 4
  - files 50–53

auto-off delay 136

## **B**

back panel controls 5

backgrounds

changing 80

customizing 141

backing up information *See* synchronizing

battery

cautions for 153

charging 25, 136, 146

conserving power for 27, 134

extending life of 132, 147

recharging 27, 136

battery icon 146

Beam Category command 71

Beam Contact command 67

Beam Item command 71

Beam Status dialog box 67

beaming 4, 28, 67, 136, 150

birthdays 65

Blazer application *See* web browser

blinking cursor 19

Bluetooth application

additional information for 103

computer setup options for 99

features 84

icon on status bar 12

setting connection information 93

setting up connections 94–96

status bar icon 93

Bluetooth devices

sending applications to 28, 131

sending entries to 28, 131

setting up 93

Bluetooth icon 8

Bluetooth technology 83, 84

BMP files 37

bold fonts 140

bookmarks 126

browsing the web 8, 97, 124

built-in applications 6

Business Card command 67

business cards 67

buttons

locking 134

navigator 16

not responding 4

## **C**

Calculator application 7

Calculator icon 7

calculators 7

calendar

color-coding appointments 69

formatting 144

Calendar application

checking schedules in 70

customizing 141

entering birthdays for 65

opening 6, 63, 68, 70, 71

scheduling appointments in 68–69

selecting dates on 72

setting alarms 71

Calendar icon 6, 63

calendar views 70

calibration 142

capitalization 78

Card Info application 9, 131

Card Info icon 9

card readers 53

categorizing

information 28, 69

tasks 73

CDs 54

Change your synchronization option 148

changing

backgrounds 80

email accounts 119

fonts 139–140

character entry 18, 64, 125

options 144

charging battery 25, 136, 146

checking for email 112, 113

Choose Date command 72

cleaning your handheld 25

clock 137–138

*See also* World Clock

Color Theme Preferences screen 133

color-coding

appointments 69

messages 119

colors, applying to notes 80

commands 23

communication settings 150

compact discs 54

completed tasks 74

computers

preinstalled software for 6

synchronizing handheld with 99

troubleshooting synchronization

problems 147

conduit 31

configuring connections 144

confirmation tones 130

- conformity declaration 152
- connecting
  - to AC charger 136
  - to mobile phones 98
  - to other devices 83
  - to the Internet 84
- connections
  - additional information for 103
  - configuring 144
  - customizing 123, 126
  - omitting passkeys for 95
  - precautions for 25, 155
  - setting preferences for 119
  - setting up phone 94–96
  - setting up wireless 99
  - troubleshooting 150
  - unable to establish 93
- conserving power 27, 134
- contacting ISPs 96
- contacts
  - adding 66
  - adding contacts 64
  - entering from Outlook 148
  - entering in memos 78
  - managing 63
  - saving 65
- Contacts application
  - adding contact information 64–65
  - additional information for 75, 82
  - beaming contacts 67
  - customizing 75
  - locating 66
  - opening 6, 64, 67
  - saving information in 65
  - searching from 66

- Contacts icon 6, 63
- continuous events *See* repeating events
- controls, handheld 2
- copying
  - applications 131
  - photos 45
  - videos 45
- corporate email accounts 119
- CPUs
  - preinstalled software for 6
  - troubleshooting synchronizing problems 147
- creating
  - appointments 68
  - contacts 64, 66, 67
  - email messages 113
  - memos 77, 78, 79
  - MP3 files 54
  - notes 80
  - photo albums 41
  - reminders 65
  - song lists 57
  - tasks 63, 72
  - video albums 41
- current date and time 137
- cursor 19
- customer support 28, 57, 61, 119, 150
- customizing
  - backgrounds 141
  - connections 123, 126
  - Contact application 75
  - handheld 9, 132
  - Inbox 119
- cutting and pasting 82

**D**

- data entry 4, 19, 28, 144
  - input area for 2
- Date & Time Preferences screen 137
- dates
  - assigning to appointments 68
  - formatting 144
  - scheduling reminders for 65
  - selecting on calendar 72
  - setting 137–138
  - setting due 72
  - sorting by 81
- Day View (Calendar) 68, 70
- Day View icon 68
- Deactivate Keylock button 134
- delays 136
- deleting
  - See also* removing
  - applications 28, 131
  - email accounts 119
  - files 131
  - memos 82
  - messages 123
  - photos 45
  - photos from album 42
  - video from album 42
  - videos 45
- desktop software, installing 6
- device
  - ESD and 154
- Device name field 93
- dial-up accounts 96, 98
- dictionaries 128
- Digitizer Preferences screen 142
- Discoverable setting 87, 93



- display options 119
  - Favorites 141
- Display Options command 141
- display preferences 135
- displaying
  - application icons 146
  - calculators 7
  - expansion card information 9
  - expense reports 6
  - information 2
  - memos 79
  - notes 81
  - PDF files 7
  - personal calendars 63
  - photos 45
  - schedules 70
  - tasks 73, 75
  - videos 45
  - web pages 125
  - World Clock 9
- do's and don'ts 25
- documentation 28, 45, 57, 75, 82, 119, 150
- Documents application 7
  - creating files 59
  - editing files 59
  - opening files 60
  - viewing files 59
- Documents To Go application 30, 59
  - See also* Documents application
- downloading
  - attachments 114
  - files 126
- drawing freehand 77
- due dates 72
- dummy expansion card 129

## E

- eBooks 7
- Edit Categories command 73
- editing 79, 80, 81, 119
  - See also* changing
- electrostatic discharge 154–156
- email
  - See also* email accounts
  - accessing 8, 91, 95, 97, 101
  - additional information for 119
  - addressing 75, 113
  - attaching events to 75, 82
  - attaching photos to 45
  - automatically checking for 112, 113
  - automatically retrieving 119
  - changing maximum size 112
  - composing 113
  - deleting accounts for 119
  - downloading attachments 114
  - Microsoft Exchange ActiveSync 118
  - receiving 97
  - sending 97, 113
  - setting preferences for 119
  - synchronizing 119
- email providers 110
  - See also* ISPs
- entering
  - information 2, 4, 18–22, 28, 144
  - passwords 96, 111
  - URLs 125
- Enterprise Software link 9
- entries
  - defined 19
  - sorting 75, 82
- eraser 80

- eReader 7
- ESD (electrostatic discharge) 154–156
- Essential Software option 8
- Euro, in onscreen keyboard 20
- events
  - See also* appointments
  - contact information and 65
  - defined 68
  - entering 69
  - setting alarms for 71
- Excel files 7, 30, 59
- exchanging
  - applications 28, 131
  - expansion cards 131
  - files 84
  - information 4, 28
- expansion cards
  - adding applications to 10, 131
  - additional information for 131
  - benefits of 128
  - deleting applications from 131
  - displaying contents of 131
  - displaying information about 9
  - dummy card 129
  - inserting 4, 130
  - naming 131
  - overview 127
  - preventing damage to 129
  - removing 129
  - saving multimedia files on 45
  - transferring audio files to 53
  - types of 128
- Expense application 6
- Expense icon 6
- expense reports 6

## **F**

- fade setting 141
- FAQs 145
- Favorites View
  - adding background to 141
  - changing entries 133
  - defined 9
  - using 14
- FCC Statement 151
- file transfers 126
- file types 47, 50
- files
  - attaching to email 117
  - deleting 131
  - removing from expansion cards 131
  - sharing 84
- filing appointments 69
- Find icon on status bar 12
- finding contacts 66
- font styles 139, 140
- fonts
  - changing 139–140
  - customizing email 119
- formats
  - audio files 46
  - setting 144
- formatting information 144
- freehand drawing 77
- frequently asked questions 145
- front panel controls 2
- frozen screen 5, 149, 150
- full-screen writing 80
  - icon on status bar 12

## **G**

- Game Sound pick list 143
- games 128, 143
- General Packet Radio Service (GPRS) 94
- Go To Date dialog box 68
- going online 84
- GPRS mobile phones 94
- Graffiti 2 writing 18, 28, 144
- GSM mobile phones 94

## **H**

- handheld
  - adding applications to 28, 145
  - adding other software 128
  - additional information for 28
  - charging battery for 136
  - connecting to AC charger 136
  - controls described 2
  - copying applications on 131
  - customizing 9, 132
  - do's and don'ts 25
  - losing 134
  - naming 93
  - not responding 134, 149
  - opening 149
  - preinstalled applications for 6
  - protecting 95, 144
  - recharging 25, 146
  - recharging battery 27, 136
  - removing applications from 28
  - restarting 149
  - running out of space on 128
  - setting auto-off delay for 136
  - setting power preferences for 135–136
  - synchronizing 145, 146, 147

- troubleshooting 142, 145
  - turning on and off 4, 134
  - upgrading 145
  - viewing applications on 2
  - viewing information on 2
  - Wi-Fi radio 5
  - hard resets 149, 150
  - headphone jack 4
  - headphones 25
  - headsets 4
  - help 28, 45, 57, 75, 82, 119, 150
  - Help menu 147
  - high-speed connections 98
  - holidays 69
  - home page 126
  - HotSync icon 6
  - HotSync Manager 99, 147
    - starting 6
  - HotSync Online Troubleshooting Guide 147
  - HotSync technology 10
- ## **I**
- icons 146
  - image files 37
  - IMAP protocol 110
  - IMAP servers 111
  - Inbox 119
  - incoming mail servers 111
  - incoming messages 123
  - information
    - accessing 16
    - backing up 30, 128
    - categorizing 28, 69
    - displaying 2
    - entering 2, 4, 18–22, 28, 144

- formatting 144
- losing 149
- managing 10
- owner 134
- saving 146
- sharing 4, 28, 77, 131
- synchronizing 29–32
- updating 29, 30

infrared port *See* IR port

input area 2

- icon on status bar 12

inserting expansion cards 4, 130

installing

- applications 6, 30
- third-party applications 145

Internet

- Bluetooth 96
- connecting to 84
- selecting service provider for 98
- using web 124

Internet Message Access Protocol (IMAP) 110

Internet Service Provider 111

IR port 67

- See also* beaming
- Bluetooth phone 103
- location of 4

ISP

- See* Internet Service Provider

iTunes application, transferring songs 54

**J**

JPG files 37

**K**

keyboard

- connecting to portable 79
- entering information from 19
- onscreen types 20

Keylock 4, 134

Keylock Preferences screen 134

**L**

landscape view 13

Large bold icon 140

Large font icon 140

listening to music 46, 47, 50, 56

local settings 137, 144

locating contacts 66

Location pick list 137

locking handheld buttons 134

Look Up line (Contacts) 66

losing handheld 134

losing information 30, 146, 149

low battery 27, 146

**M**

Mac information

- installing extra software from CD 8
- Send To Handheld droplet 34
- synchronizing handheld 148
- transferring MP3 files to handheld 53

mail servers 111

Mail Service pick list 110

math calculators 7

Media application

- adding photo to contact 65
- additional information for 45
- backing up information in 10

- benefits of 36
- companion applications for 11
- displaying photos or videos 38
- overview 36

Media icon 7

memos

- adding contact information to 78
- backing up 10
- creating 77, 78, 79
- deleting 82
- displaying 79
- editing 79
- saving 78
- synchronizing 82

Memos application

- opening 6, 78, 79, 80, 81
- selecting memos 79
- writing memos with 78

Memos icon 6, 77

Memos list 78, 79

menu bar 23

menus 23

- icon on status bar 12

message summary view 119

messages

- automatically resending 119
- color-coding 119
- deleting 123
- receiving 44, 123
- replying to 123
- synchronizing 119

Microsoft Exchange ActiveSync 118

Microsoft Outlook

- applications that synchronize 31
- synchronize with 35

Microsoft Outlook *See* Outlook  
Microsoft Windows systems *See* Windows information  
Microsoft Word files 7, 30  
Mini-USB connector icon 5  
missing applications 7  
mobile phones  
    compatibility 94  
    connecting to 98  
    connecting to Internet from 98  
    setting up connection 94  
Month View (Calendar) 70  
moving  
    photos 43  
    videos 43  
MP3  
    files 46, 50–53  
    players 46  
MultiMediaCard expansion cards, types 128  
multiple email recipients 113  
music  
    listening to 46, 47, 50  
    playing 56  
    storing 128  
Music application 57  
music files *See* audio files

## N

names *See* usernames; contacts  
naming  
    email accounts 110  
    expansion cards 131  
    handheld 93  
    photo albums 42  
    video album 42

navigator 3, 16  
network connections  
    setting preferences for 119, 123, 126  
    setting up 144  
networks  
    Bluetooth 35  
Note Pad  
    backing up information in 10  
    creating notes from 80  
    displaying notes in 81  
    opening 6  
    overview 77  
    setting preferences for 80  
Note Pad icon 6, 77  
notes  
    *See also* memos; Note Pad  
    attaching alarms to 82  
    backing up 10  
    creating 80  
    editing 80, 81  
    saving 80  
    selecting 81  
    sorting 81  
numbers 18, 144

## O

Office files 58  
omitting passkeys 95  
online documentation 28, 45, 57, 75, 82, 119, 131, 150  
Online Troubleshooting Guide 147  
onscreen keyboard *See* keyboard  
Open URL  
    dialog box 125  
    icon 125

opening  
    handheld 149  
    handheld menus 23  
    HotSync Manager 6, 99  
    Note Pad 6  
    Pocket Tunes 7  
    text messages 122  
orientation of screen 13  
outgoing mail servers 111  
Outlook  
    marking completed tasks and 74  
    synchronizing with 148  
overdue tasks 73  
owner information 134, 144  
Owner Preferences screen 134

## P

Palm Desktop software 145  
    completing repeated tasks and 74  
    described 10  
    synchronizing with 148  
Palm OS devices, beaming to 28  
paper clip icon 114  
partnership 95  
passkeys 95, 101  
Password check box 111  
passwords  
    Bluetooth 95, 96, 101  
    entering 111  
pasting text 82  
PC Setup screen 99  
PCs *See* personal computers  
PDF files 7  
pen 80  
Pen selector 80

- pen widths 80
- performance 25
- personal computers
  - preinstalled software for 6
  - synchronizing handheld with 31
  - troubleshooting synchronization 147
- phone calls 75
- phone connections 94–96
- Phone Link Updater application 94
- Phone Lookup 66
- phone numbers, sharing 4
- photo albums
  - additional information for 45
  - creating 41
  - moving photos in 43
- photos
  - adding to albums 42
  - adding to contacts 65
  - copying 45
  - deleting from album 42
  - displaying 45
  - emailing 45
  - moving 43
  - selecting as backgrounds 141
  - sharing 33
  - storing 128
  - viewing 38
- Picture box 65
- playing music 46, 47, 50, 56
- playlists 57
- Pocket Tunes application
  - compatible formats for 47, 50
  - getting help with 57
  - icon 7
  - opening 7, 56

- overview 46
- POP protocol 110
- POP servers 111
- portable keyboards 79
- portrait view 13
- ports 4
- Post Office Protocol (POP) 110
  - See also* POP servers
- Power button 4
- power consumption options 136
- power preferences 135–136
- Power Preferences screen 136
- PowerPoint files, creating and viewing 59
- power-saving settings 136
- precautions 155
- preferences
  - overview 132
  - setting connection 119
  - setting email 119
  - setting locale-specific 137
  - setting network connection 123, 126
  - setting text messaging 123
- Preferences screen 9
- Prefs icon 9
- preinstalled applications 6
- printing expense reports 6
- prioritizing tasks 72
- privacy settings
  - contacts 75, 82
  - handheld 28, 144
- protecting
  - information 128
  - your handheld 28, 144
- protecting your handheld 28
- protocol (defined) 110

Protocol pick list 110

## Q

- questions and answers 145
- quick buttons
  - not responding 4
  - opening applications from 6
- Quick Connect option 75
- Quick Install software 10
- Quick Tour 18, 24

## R

- radio 5, 7
- reading text messages 122
- RealPlayer
  - converting songs on CDs 54
  - transferring songs from CD 54
- reboots 149, 150
- receiving email 97
- receiving messages 44, 123
- recharging battery 27, 136
- recharging handheld 25, 146
- recurring tasks 75
- refreshing web pages 126
- reminders
  - entering 69
  - scheduling 65
  - setting alarms for 82
- removing
  - See also* deleting
  - expansion cards 129
- repeating tasks 74, 75
- replying to text messages 123
- resending messages 119
- reserving blocks of time 75

reset button 5, 149  
resetting local settings 137  
restarting handheld 149  
rotating the screen 13  
running out of space 128

## S

saving

- attachments 114
- contacts 65
- information 146
- memos 78
- notes 80
- tasks 72

schedules 63, 70

*See also* appointments; calendar

scheduling

- appointments 68–69
- reminders 65

scheduling conflicts 63

screen

- aligning 142
- caring for 25
- changing colors of 133
- changing fonts for 139, 140
- frozen 5, 149, 150
- landscape and portrait views 13
- not responding 4, 5
- viewing information on 2

screen rotation 13

Screen rotation button 13

scrolling 68

SD memory cards 128

SDIO accessories 128

SDIO cards 128

searching for information 66

Secure Digital input/output (SDIO) 128

security

- WEP Encryption 89

- Wi-Fi 89

- WPA-PSK 90

security options

- contacts 75, 82
- handheld 28, 95, 144

Security settings 134

Select a Color Theme dialog box 133

Select Font dialog box 140

Select User dialog box 32

semicolon (;) characters 113

Send To Handheld droplet 10

sending

- email 97, 113
- text messages 84, 95, 120, 121

service (defined) 98

Service pick list 98

Set Date dialog box 138

Set Time dialog box 69, 138

setting alarms 71, 72, 82

settings 23

*See also* preferences

sharing

- files 84
- information 4, 77, 131
- photos 33

sharing information 28

Short Message Service *See* SMS

- application

short messages 120

side panel controls 4

Silent profile 143

sketching 77

slide shows 38, 45

Small bold icon 140

Small font icon 140

small fonts 135

SMS application

- additional information for 123

- benefits of 120

- installing 8

- messages 121

- opening 121, 122

- sending text messages 121

SMS messaging 8

SMTP servers 111

soft resets 149

software 150

*See also* specific application

- adding other 128

- included on handheld 6

Solitaire 7

song files *See* audio files

song formats 46

song lists 57

songs 56

Sort by pick list 81

sorting

- information 75, 82

- notes 81

sound files

*See* audio files

sounds 143

Sounds & Alerts screen 143

speaker 5, 143

special characters 18

specifications 153

spreadsheets 7  
    *See also* Excel files  
        creating and viewing 59  
starting HotSync Manager 6  
static electricity 25, 154–156  
status bar icon descriptions 12  
stopping MP3 player 56  
stopping slide shows 38  
storage 127, 128  
stylus 4, 25  
Subject fields 113  
subject lines (email) 113  
supported file types 47, 50  
switching between applications 148  
symbols 18, 64  
synchronizing  
    backing up information 30, 128  
    handheld 145, 146, 147  
    information 29–32  
    messages 119  
    options 148  
    problems 150  
    software 31  
    wirelessly 84, 99  
    with Microsoft Outlook 148  
system information, icon on status bar 12  
System Sound pick list 143

## T

tapping 142, 148  
Task Preferences settings 75  
tasks  
    categorizing 73  
    combining with appointments 63  
    completing 74

    creating 72  
    defining recurring 75  
    displaying 73, 75  
    entering from Outlook 148  
    organizing 73  
    prioritizing 72  
    saving 72  
    setting alarms for 72  
Tasks application  
    adding tasks 72  
    marking completed tasks 74  
    opening 6, 63, 72, 73, 74  
    saving information in 72  
    setting display options for 73  
Tasks icon 6, 63  
technical assistance 28, 57, 61, 119, 150  
telephone numbers *See* phone numbers  
text  
    adjusting fade setting for 141  
    changing fonts for 139  
    cutting and pasting 82  
    entering 18, 144  
text messages  
    additional information for 75  
    creating 75  
    deleting 123  
    managing 8  
    opening 122  
    sending 84, 95, 120, 121  
    setting preferences for 123  
    viewing 122  
third-party applications 145  
thumbnails 45  
TIFF files 37  
time

    formatting 144  
    reserving blocks of 75  
    scheduling 69  
    setting 71, 137–138  
    setting location-specific 9  
top panel controls 4  
touchscreen  
    aligning screen 142  
    defined 142  
tracking completion dates 75  
tracking expenses 6  
transferring  
    applications 10  
    information 4  
    wirelessly 84  
transferring information 31  
travel guides 128  
troubleshooting 142, 145  
trusted pair *See* partnership  
turning handheld on and off 4, 134, 136  
Tutorial 24

## U

uniform resource locators (URLs) 125  
unread mail 119  
untimed events 65, 69  
updating information 29, 30  
upgrading 145  
URLs 125  
USB sync cable 32  
User Guide 28, 35, 45, 57, 61, 75, 82, 103,  
    119, 123, 126, 131, 144, 150  
usernames  
    Bluetooth 96  
    finding in email addresses 111

- multiple users 31
  - synchronize 32
- V**
- VersaMail application 8
    - adding attachments 116
    - additional information for 119
    - benefits of 104
    - downloading attachments 114
    - sending email 113
    - setting up email accounts 109–111
  - video albums
    - creating 41
    - moving photos in 43
  - videos
    - adding to album 42
    - copying 45
    - deleting 45
    - deleting from album 42
    - displaying 45
    - moving 43
    - viewing 38
  - viewing
    - application icons 146
    - calculators 7
    - expansion card information 9
    - expense reports 6
    - information 2
    - memos 79
    - notes 81
    - PDF files 7
    - personal calendars 63
    - photo 38
    - photos 45
    - schedules 70
    - tasks 73, 75
    - video 38
    - videos 45
    - web pages 125
    - World Clock 9
  - views in Calendar 70
  - virtual private networks 119
  - volume 143
- W**
- warnings 153
  - warranty 149
  - web addresses 125
  - web browser
    - additional information for 126
    - displaying web pages 125
    - overview 124
  - web pages 125, 126
  - websites
    - accessing 84, 91, 97, 124
    - adding bookmarks for 126
    - browsing 8, 97
    - downloading files 126
    - navigating 125
  - Week View (Calendar) 70
  - WEP Encryption 89
  - Wi-Fi
    - definition 84
    - radio 5
    - security information 86
    - types of connections 84
    - WEP Encryption 89
    - WPA-PSK 90
  - Windows information, synchronization
    - options for 148
  - Windows Media Player 11
  - wireless
    - connections 83, 84, 99, 121
    - features 91, 97
    - synchronization 84, 99
  - Word files 7
    - creating and viewing 59
    - synchronizing 30
  - World Clock 71
    - displaying 9
  - World Clock icon 9
  - WPA-PSK 90
  - writing area 144
  - writing in your own handwriting 77
  - writing tool 4, 25
- Y**
- Year View 70
- Z**
- zooming 40