



**Handbook for the  
Palm™ Tungsten™ C  
Handhelds**

## Copyright

© 2003 Palm, Inc. All rights reserved. Graffiti, HotSync, MultiMail, the Palm logo, PalmModem, and Palm OS are registered trademarks, and Palm, Palm Powered, Tungsten, and VersaMail are trademarks of Palm, Inc. Palm, Inc. uses the Bluetooth trademark under express license from Bluetooth SIG, Inc., U.S.A. All other brands are trademarks or registered trademarks of their respective owners.

## Disclaimer and Limitation of Liability

Palm, Inc. assumes no responsibility for any damage or loss resulting from the use of this handbook.

Palm assumes no responsibility for any loss or claims by third parties which may arise through the use of this software. Palm, Inc. assumes no responsibility for any damage or loss caused by deletion of data as a result of malfunction, dead battery, or repairs. Be sure to make backup copies of all important data on other media to protect against data loss.

---

**IMPORTANT** Please read the End User Software License Agreement with this product before using the accompanying software program(s). Using any part of the software indicates that you accept the terms of the End User Software License Agreement.

---

## Software Download Available

Palm™ Desktop software is supplied on a CD-ROM disc. If you do not have access to a CD-ROM drive for your computer, you can download the Palm Desktop software from [www.palm.com/support/tungstenc](http://www.palm.com/support/tungstenc).

# Contents

<b>About This Book</b> .....	<b>1</b>
<b>Chapter 1: Welcome</b> .....	<b>3</b>
System requirements .....	4
Minimum requirements: Windows computers .....	4
Minimum requirements: Mac computers .....	4
Finding information .....	5
<b>Chapter 2: Exploring Your Handheld</b> .....	<b>7</b>
Locating handheld components .....	8
Locating front panel controls .....	8
Locating back panel components .....	10
Adding an expansion card .....	11
Adjusting the screen brightness level .....	12
<b>Chapter 3: Navigating and Entering Data</b> .....	<b>13</b>
Tapping .....	13
Using the navigator .....	14
Using the keyboard .....	15
Typing capital letters .....	17
Accessing international and special characters .....	17
Using the Function key .....	18
Using ShortCuts .....	19
Using elements of the handheld interface .....	20
Using Graffiti 2 writing to enter data .....	22
Activating and deactivating Writing Area preference .....	22
Learning Graffiti 2 concepts .....	23
Graffiti 2 tips .....	25
Graffiti 2 alphabet .....	26
Capital letters .....	27
Graffiti 2 numbers .....	27
Punctuation marks .....	28
Accented characters .....	29

Symbols and other special characters .....	30
Graffiti 2 Gestures .....	31
Graffiti 2 ShortCuts .....	31
Beaming data .....	32
Using your computer keyboard .....	34
Importing data .....	34
Importing data from a Windows computer .....	34
Using File Link .....	35
Importing data from a Mac computer .....	36
<b>Chapter 4: Working with Applications .....</b>	<b>37</b>
Opening applications .....	37
Other ways to open applications .....	38
Opening expansion card applications .....	38
Switching between applications .....	39
Categorizing applications .....	39
Changing the Applications Launcher display .....	40
Copying applications to or from an expansion card .....	41
Selecting copy settings .....	43
Using menus .....	43
Using menu commands and the command toolbar .....	45
Using menu commands .....	45
Using the command toolbar .....	45
Choosing application preferences .....	46
Performing common tasks .....	47
Creating records .....	47
Editing records .....	47
Deleting records .....	49
Purging records .....	50
Categorizing records .....	50
Finding information .....	54
Sorting lists of records .....	58
Attaching notes .....	60
Choosing fonts .....	61
Receiving alerts .....	62
Hiding or masking private records .....	63
Installing and removing applications .....	63
Installing files and add-on applications .....	63
Installing applications and files on a Windows computer .....	64

---

Palm Quick Install Tips .....	67
Installing applications and files on a Mac computer .....	67
Removing applications .....	69
Removing Palm Desktop software .....	70
<b>Chapter 5: Using Address Book .....</b>	<b>73</b>
Creating an Address Book entry .....	74
Selecting types of phone numbers .....	75
Changing Address Entry details .....	76
Making connections from Address Book .....	77
Address Book menus .....	80
Record menus .....	80
Options menus .....	81
<b>Chapter 6: Using Calculator .....</b>	<b>83</b>
Performing calculations .....	83
Viewing recent calculations .....	84
Using Calculator menus .....	85
<b>Chapter 7: Using Card Info .....</b>	<b>87</b>
Reviewing Card Information .....	87
Renaming a card .....	88
Formatting a card .....	88
Managing an expansion card .....	89
Using the Card Info menu .....	89
<b>Chapter 8: Using Date Book .....</b>	<b>91</b>
Scheduling an event .....	92
Selecting an event .....	95
Rescheduling an event .....	95
Setting an alarm for an event .....	95
Scheduling repeating or continuous events .....	97
Changing repeating or continuous events .....	97
Considerations for repeating or continuous events .....	98
Changing the Date Book view .....	99
Working in Week view .....	99
Working in Month view .....	100
Working in Agenda view .....	101
Spotting event conflicts .....	102

Using Date Book menus .....	103
Record menu .....	103
Options menu .....	103
<b>Chapter 9: Using Expense .....</b>	<b>107</b>
Adding expense items .....	108
Changing the date of an Expense item .....	109
Entering receipt details .....	109
Customizing the Currency pick list .....	110
Changing the default currency .....	111
Defining a custom currency symbol .....	111
Setting Show Options .....	112
Working with Expense data on your computer .....	113
Displaying the euro on your computer .....	113
Printing the euro .....	113
Using Expense menus .....	113
Record menu .....	114
Options menu .....	114
<b>Chapter 10: Using Memo Pad .....</b>	<b>115</b>
Creating memos .....	115
Reviewing memos .....	116
Using Memo Pad menus .....	117
Record menus .....	117
Options menus .....	117
<b>Chapter 11: Using Note Pad .....</b>	<b>119</b>
Creating a note .....	120
Reviewing notes .....	120
Changing Note Pad color settings .....	121
Setting an alarm for a note .....	122
Using Note Pad menus .....	123
Record menu .....	123
Options menus .....	124
<b>Chapter 12: Using Palm™ Photos .....</b>	<b>125</b>
Viewing photos .....	125
Viewing photos in Thumbnail view .....	126
Viewing photos in List view .....	126
Viewing a slide show .....	127

---

Rotating photos .....	128
Viewing photo information .....	129
Organizing photos .....	129
Sorting photos in List view .....	130
Creating an album .....	130
Filing photos in albums .....	131
Copying photos .....	131
Renaming or deleting an album .....	132
Beaming photos .....	134
Deleting photos .....	135
Working with photos on your computer .....	135
Using Palm Photos menus .....	136
Photo menu .....	136
Options menus .....	136
<b>Chapter 13: Using To Do List .....</b>	<b>137</b>
Creating list items .....	138
Setting priority .....	138
Checking off a To Do List item .....	139
Changing To Do List item details .....	140
Setting a due date .....	140
Setting To Do preferences .....	141
Using To Do List menus .....	142
Record menu .....	142
Options menu .....	142
<b>Chapter 14: Using Palm™ VersaMail™ Personal E-mail Software .....</b>	<b>143</b>
VersaMail™ application features .....	143
Getting started with the VersaMail application .....	144
Synchronizing an existing username .....	144
Upgrading a MultiMail/VersaMail database .....	144
Setting up and managing e-mail accounts .....	145
Account and connection types .....	145
Network e-mail account prerequisites .....	146
Creating a network e-mail account .....	149
Creating a synchronize-only account .....	155
Editing e-mail accounts .....	163
Deleting an e-mail account .....	169

Selecting a different service for a given e-mail account . . . . .	170
Troubleshooting account access problems . . . . .	172
Getting, sending, and managing e-mail . . . . .	172
Getting e-mail . . . . .	173
Auto get mail with notification . . . . .	175
Creating and editing mail folders . . . . .	194
Creating and sending new e-mail . . . . .	195
Working with URLs . . . . .	207
Working with attachments . . . . .	207
Deleting messages . . . . .	217
Emptying the trash . . . . .	220
Marking messages as read or unread . . . . .	221
Setting preferences for getting and deleting e-mail . . . . .	223
Adding or updating an Address Book entry directly from a message . .	224
Synchronizing e-mail between the handheld and the desktop . . . . .	225
Configuring an account in HotSync Manager . . . . .	226
Setting synchronization options and account settings . . . . .	227
Converting attached files . . . . .	240
Synchronizing an account . . . . .	242
Using SSL with the conduit . . . . .	244
Going beyond the basics . . . . .	244
Managing mail filters . . . . .	245
Managing mail settings . . . . .	249
Adding APOP to an account . . . . .	257
Adding ESMTP to an account . . . . .	259
Setting advanced account preferences . . . . .	260
Cutting and copying text from an e-mail message for use in other applications . . . . .	261
Using the command bar . . . . .	262
Changing e-mail header details . . . . .	263
Backing up mail databases . . . . .	265
Wireless IMAP folder synchronization . . . . .	265
Using Secure Sockets Layer (SSL) . . . . .	268
Viewing the wireless coverage indicator . . . . .	268
Five-way navigation in the VersaMail application . . . . .	269
Keyboard shortcuts in the VersaMail application . . . . .	271



---

<b>Chapter 15: Using PalmSource® Web Browser</b> .....	<b>273</b>
Using Web Browser's features .....	273
Web Browser is easy to use .....	273
Web Browser is fast .....	273
Web Browser is secure .....	274
What Web Browser looks like .....	274
Getting help in Web Browser .....	275
Opening Web Browser .....	276
Browsing the Web on your handheld .....	276
Visiting a web page .....	276
Following a link .....	277
Returning to a web page you just visited .....	277
Going to your home page .....	278
Downloading a file to your handheld .....	278
Stopping the download process .....	279
Refreshing a page .....	279
Viewing information about a web page .....	280
Bookmarking your favorite pages .....	280
Adding a bookmark .....	281
Visiting a bookmarked page .....	281
Editing information about a bookmark .....	282
Deleting a bookmark .....	282
Saving pages .....	283
Saving a page .....	283
Opening a saved page .....	283
Editing information about a saved page .....	284
Copying text from a page to another application .....	285
Deleting a saved page .....	285
Searching for text on a page .....	285
Finding web pages you recently visited .....	286
Returning to a page you visited .....	286
Using Web Preferences .....	286
Setting General Preferences .....	287
Setting Connecting Preferences .....	290
Setting Privacy Preferences .....	291
Finding the Web Browser version number .....	293
Web Browser menus .....	293
Page menu .....	294
Options menu .....	294

<b>Chapter 16: Using World Clock</b> .....	<b>295</b>
Setting the primary location .....	295
Choosing a different primary location .....	297
Setting the secondary locations .....	298
Adding a location .....	298
Modifying a Location .....	300
Removing a location .....	300
Setting an alarm .....	301
Using World Clock menus .....	302
<b>Chapter 17: Performing HotSync® Operations</b> .....	<b>303</b>
Selecting HotSync setup options .....	303
Customizing HotSync application settings .....	305
Conducting network HotSync operations .....	308
Connecting to your computer through a wireless LAN .....	308
Performing a wireless network HotSync operation .....	309
Performing cradle/cable HotSync operations .....	312
Performing a cradle/cable HotSync operation: Windows computer ...	312
Performing a direct HotSync operation: Mac computer .....	314
Conducting IR HotSync operations .....	317
Preparing your computer for infrared communication .....	317
Performing an IR HotSync operation .....	319
Returning to cradle/cable HotSync operations .....	319
Using File Link .....	320
Creating a user profile .....	321
Performing the first HotSync operation with a user profile .....	322
<b>Chapter 18: Setting Preferences for Your Handheld</b> .....	<b>325</b>
Setting General Preferences .....	326
Date and Time preferences .....	327
Digitizer preferences .....	328
Formats preferences .....	328
Graffiti 2 Preferences .....	330
Keyboard preferences .....	330
Power preferences .....	332
Sounds and Alerts preferences .....	334
Writing Area preferences .....	335
Setting Communication Preferences .....	336
Connection preferences .....	337
Network preferences .....	339

---

VPN preferences .....	350
Wi-Fi preferences .....	355
Setting Personal Preferences .....	364
Buttons preferences .....	365
Color Theme preferences .....	366
Owner preferences .....	367
Security preferences .....	368
ShortCuts preferences .....	383
<b>Appendix A: Maintaining Your Handheld .....</b>	<b>385</b>
Caring for your handheld .....	385
Battery considerations .....	386
Resetting your handheld .....	386
Performing a soft reset .....	386
Performing a hard reset .....	387
<b>Appendix B: Frequently Asked Questions .....</b>	<b>391</b>
Software installation problems .....	392
Operating problems .....	393
Tapping and writing problems .....	395
Application problems .....	395
HotSync problems .....	397
Beaming problems .....	402
Recharging problems .....	403
Security problems .....	404
Wi-Fi and VPN problems .....	404
E-mail problems .....	406
Technical support .....	407
<b>Appendix C: Wi-Fi Frequencies .....</b>	<b>409</b>
<b>Product Regulatory and Safety Information .....</b>	<b>411</b>
<b>Index .....</b>	<b>417</b>



# About This Book

This handbook is designed to help you get up and running quickly on your Palm™ Tungsten™ C handheld. It describes all you need to know about how to use your handheld and the applications that come with it. It describes:

- Enabling wireless features
- Locating all the parts of your handheld
- Viewing and entering data
- Working with expansion cards
- Using your handheld with your computer
- Personalizing your handheld with your own preference settings

After you become familiar with the basic functionality of your handheld, you can use the rest of this handbook as a reference for performing less common tasks, for maintaining your handheld, and for solving problems that might arise as you operate your handheld.



# Welcome

Your new Palm™ Tungsten™ C handheld is wirelessly enabled so that you can use it to transmit and receive information over the airwaves. Use your handheld to do the following:

- Connect to your corporate or personal local area network (LAN) wirelessly with a built-in 802.11b radio, enabling you to read, compose, and send e-mail on the go.
- Browse or search the Internet through your wireless LAN.
- Stay organized and on time by keeping your appointments, contact information, and to-do items in one place.
- Wirelessly connect in coffee shops and airports that have wireless LAN service. A service subscription agreement is required for you to access these services.

---

**IMPORTANT** Your Tungsten C handheld operates in the Industry Scientific and Medical band (ISM). Not all countries support all channels in the ISM band. Because the regulations for wireless communication vary between countries, the Tungsten C handheld is only certified for use in the country where it was originally sold. For more information on which channels your handheld supports, see [Appendix C](#).

---

Before you can use all these features, you must set up your handheld and install software on your desktop computer.

Your handheld comes with an easy-to-follow installation guide, *Palm™ Tungsten™ C Read This First*, that walks you through the process of successfully setting up your handheld. The guide contains important information that must be followed for initial setup of the features available on your handheld.

---

**IMPORTANT** If you are upgrading from another Palm OS® handheld, see [www.palm.com/support/tungstenc](http://www.palm.com/support/tungstenc) for important upgrade instructions before beginning your Tungsten C handheld installation.

---

## System requirements

Before you install and operate Palm™ Desktop software, your computer system must meet the following minimum requirements.

### Minimum requirements: Windows computers

The minimum requirements for Windows computers are as follows:

- IBM-compatible Pentium-class computer
- One of the following operating systems:
  - Windows NT 4.0 Workstation with SP6 or later (requires a serial cradle/cable, sold separately, and administrator rights to install Palm Desktop software)
  - Windows 98
  - Windows ME
  - Windows 2000 Pro (requires administrator rights to install Palm Desktop software)
  - Windows XP Home or Pro (requires administrator rights to install Palm Desktop software)
- Internet Explorer 4.1
- 50 megabytes (MB) available hard disk space
- VGA monitor or better (16 Bit or High Color, and 800 x 600 resolution recommended)
- CD-ROM or DVD-ROM drive
- Mouse
- One available USB port or serial port (serial cradle/cable sold separately)

### Minimum requirements: Mac computers

The minimum requirements for Mac computers are as follows:

- Mac computer or compatible with a PowerPC processor
- Mac OS X, version 10.1.2 or later
- 25MB available hard disk space
- 12MB available RAM
- Monitor that supports screen resolution of 800 x 600 or better
- CD-ROM or DVD-ROM drive
- Mouse
- One available USB port



## Finding information

For installation information, see the *Palm™ Tungsten™ C Read This First* that came with your Tungsten C handheld. For information to help you connect to your wireless LAN, see the *Wi-Fi Getting Started Guide*. For comprehensive information about using your handheld, continue reading this electronic handbook.

For support information, upgrade information, articles, and answers to questions, see [www.palm.com/support/tungstenc](http://www.palm.com/support/tungstenc).

For more information about using Palm Desktop software, see the following:

- The handheld tutorial, Quick Tour. To access this tutorial, tap the Quick Tour icon from the Applications main screen.
- The electronic *Palm™ Desktop Software for the Macintosh User's Guide*. To access this guide, open the Palm folder and then open the Documentation folder. Double-click the file Palm Desktop.pdf.
- The online help for Palm Desktop software. To access the online help, open Palm Desktop software and select the Help menu.



# Exploring Your Handheld

Your Palm™ Tungsten™ C handheld uses a wireless LAN to help you stay in touch with important information while you are away from your desk. You can stay organized, on time, and up-to-date with daily tasks. Use your new handheld to do the following:

- Compose and securely send and receive business or personal e-mail through your wireless LAN.

**NOTE** Some companies restrict access to internal e-mail accounts when using a handheld. Check your company or network administrator for their policy on the use of handhelds.

- Receive alerts when a new e-mail arrives or a reminder occurs. Rely on any or all of the three alert modes: the indicator light, vibrator, or alarm sound.
- Set preferences for how you receive alarms: hearing a sound, seeing a blinking indicator light, or feeling your handheld vibrate. Choose any combination.
- Browse or search the Internet.
- Enter your schedule in Date Book.
- Keep all your contact names, addresses, and phone numbers in Address Book.
- Prioritize and assign your tasks a due date in To Do List.
- Set alarms from World Clock, Note Pad, and Date Book to keep yourself on schedule and remind yourself of appointments, redial reminders, and notes.
- Synchronize your data with Palm™ Desktop software on your Windows or Mac computer so you can work with your personal information on your computer and maintain a copy of your information.
- Insert SD, MultiMediaCard, or SDIO expansion cards to add more software or memory, or to back up your data.
- Beam information to another device that has an infrared (IR) port.

## Locating handheld components

Take a few moments to locate the front and back panel components of your handheld.

### Locating front panel controls

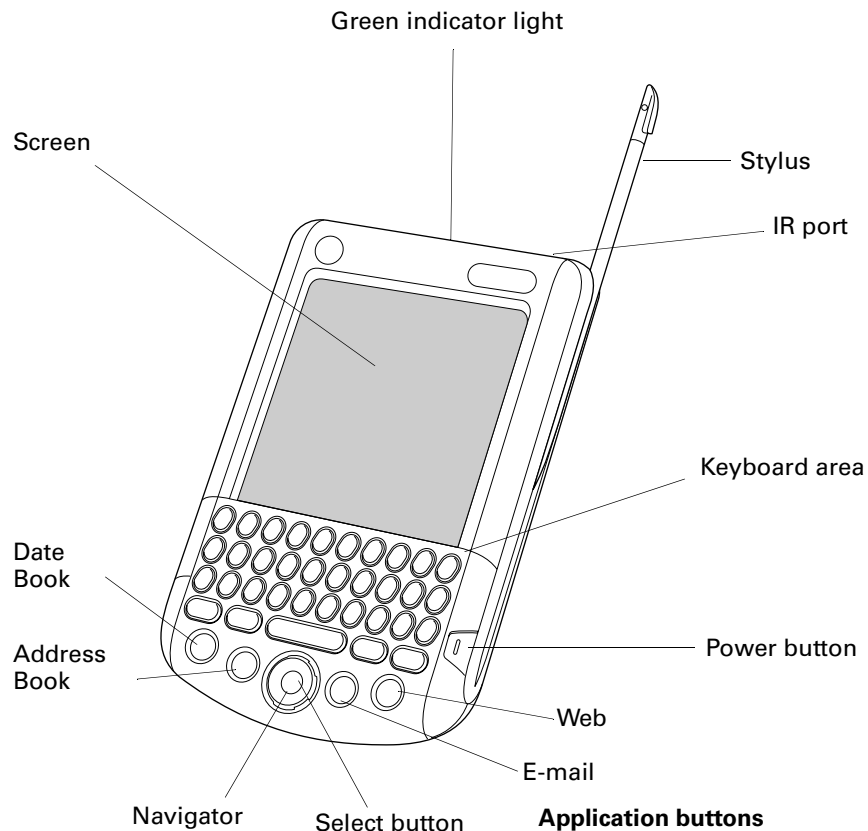

**IR port** Uses infrared technology to transmit data to and receive data from other Palm OS® handhelds, and to perform HotSync® operations. See [“Using elements of the handheld interface”](#) in [Chapter 3](#) and see [“Conducting IR HotSync operations”](#) in [Chapter 17](#) for more information.

**Keypad** The area where you type letters and numbers, and access special function keys. See [Chapter 3](#) to learn how to type characters.

---

<b>Power button</b>	<p>Turns your handheld on or off. If your handheld is turned off, pressing the power button turns the handheld on and returns you to the last screen you viewed.</p> <p>If your handheld is turned on, pressing the power button turns the unit off.</p> <p>Pressing and holding the Power button opens the Adjust Brightness dialog box enabling you to adjust the screen brightness. See <a href="#">“Adjusting the screen brightness level”</a> later in this chapter.</p>
<b>Application buttons</b>	<p>Activate the individual handheld applications that correspond to the icons on the buttons: Date Book, Address Book, E-mail, and Web. See <a href="#">“Buttons preferences”</a> in <a href="#">Chapter 18</a> for details on reassigning these buttons to open any application on your handheld.</p>
<b>Navigator</b>	<p>The five-way navigation button enables you to move up, down, right, and left in pick lists and menus. You can scroll down to view information below the viewing area, and scroll up to view the information above the viewing area. The navigator also has some special functions that are described in this handbook.</p>
<b>Select button</b>	<p>The navigator center Select button enables you to select items. The Select button also has some special functions that are described in this handbook.</p>
<b>Screen</b>	<p>Displays the applications and information stored in your handheld. It is touch-sensitive and responds to the stylus.</p>
<b>Green indicator light</b>	<p>A blinking green light indicates:</p> <ul style="list-style-type: none"><li>■ An e-mail message has arrived.</li><li>■ An alarm or event notification has occurred.</li></ul> <p>A dialog box appears, describing the reason for notification. Acknowledging the notification turns off the indicator light.</p> <p>The light also indicates that the handheld is properly placed in the cradle.</p>
<b>Stylus</b>	<p>Slides in and out of the slot in the side channel of the handheld. To use the stylus, remove it from the slot and hold it as you would a pen or pencil. Unscrew the top of the stylus to access the reset tool.</p>

## Locating back panel components

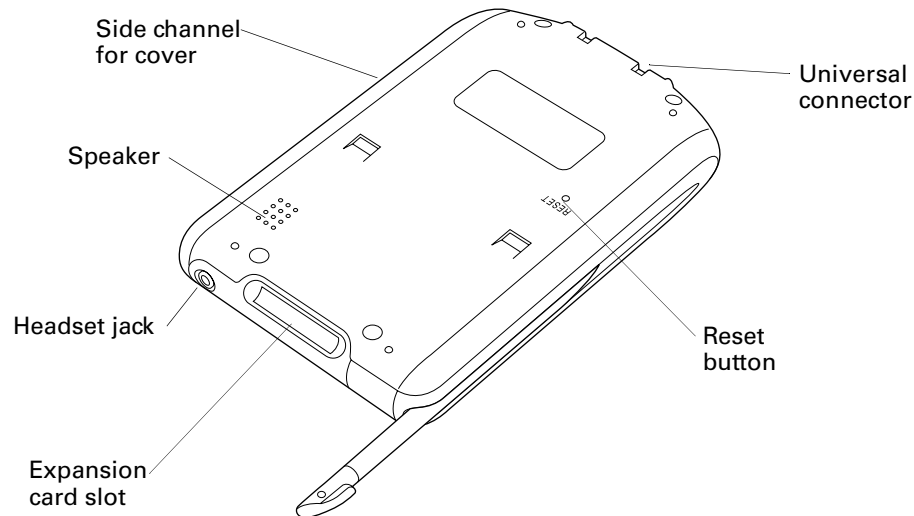

**Universal connector** Connects your handheld to the cradle, which in turn connects to the back of your computer and through the AC adapter to the wall current. This allows you to recharge your handheld as well as update the information between your handheld and computer, using HotSync technology.

The universal connector also connects peripheral hardware devices to your handheld.

**Reset button** Under normal use, you should not have to use the reset button. See [“Resetting your handheld”](#) in [Appendix A](#) for information about when and how to use the reset button.

**Expansion card slot** Accepts SD, MultiMediaCard, and SDIO expansion cards, enabling you to add more memory, applications, or other functionality. You can also back up data to an expansion card.

**NOTE** Expansion cards are purchased separately.

**Headset jack** Connects a hands-free headset to your handheld, enabling you to record and playback voice memos. You can also listen to audio-enabled applications with the privacy of using a headset.

**Speaker** For improved system sounds and the playing of audio files, such as voice recording (.wav) or multimedia.

**Side channel** The left side channel holds the front cover, which slides in and out.

## Adding an expansion card

A tiny expansion card (sold separately) increases the variety of tasks you can do and the amount of space you have for storing software and data on your handheld.

### To insert a card:

1. Insert the card.
2. Push the card in with your thumb. You feel the card lock and hear the system sound.

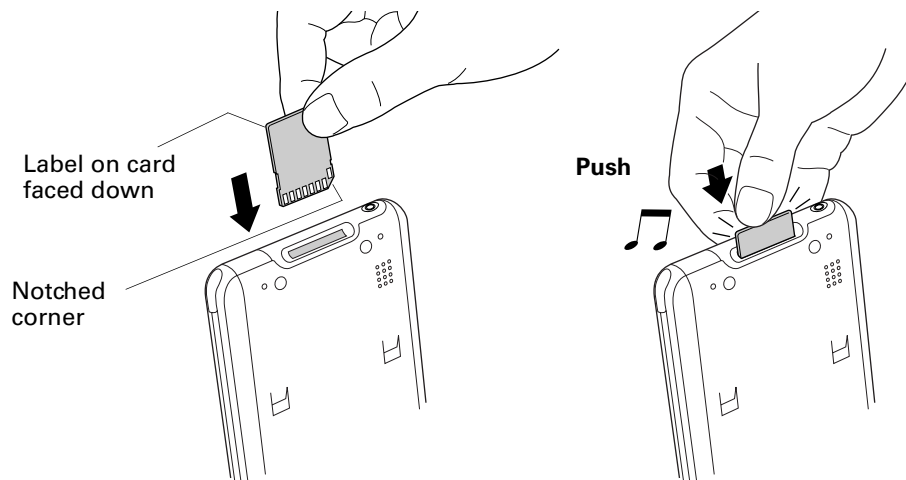

### To remove a card:

1. Push lightly against the card with your thumb.

When the card is released, you hear the system sound (provided that system sounds are turned on). See [“Sounds and Alerts preferences”](#) in [Chapter 18](#) for information on turning system sounds on and off.

---

**IMPORTANT** You can damage the expansion slot if you pull the card out of the expansion slot before you hear the tone and it releases from the expansion slot.

---

2. Slide the card out of the expansion slot.

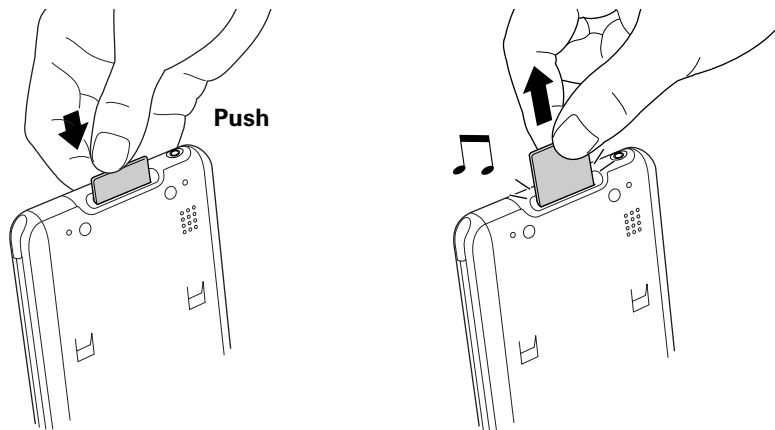



For complete information about working with expansion cards, see [Chapter 7](#).

## Adjusting the screen brightness level

The screen brightness makes it easy for you to see the information on your handheld. The screen brightness level can be adjusted to make of viewing easier and to extend battery life. You can adjust the brightness level using the Adjust Brightness dialog box.

**To adjust the screen brightness level:**

1. Perform one of the following:
  - Press Function  + Brightness .
  - Press and hold the Power button.
2. Tap to the left or right of the slider to adjust the brightness in small increments, or drag the slider to change the brightness in large increments.



# Navigating and Entering Data

This chapter explains how to enter data into your handheld, navigate around the interface, and use menu commands. There are several ways to enter data, to navigate, and to use menu commands:

- Tapping
- Using the five-way navigator
- Using the handheld keyboard
- Using Graffiti® 2 writing
- Beaming data from another device that has an infrared port
- Entering or importing data in Palm™ Desktop software and then synchronizing with your handheld

## Tapping

Like using a mouse to click elements on a computer screen, using the stylus to tap elements on your handheld screen is the basic action that gets things done on your handheld.

The first time you start your handheld, setup instructions appear on the screen. These instructions include a calibration screen. Calibration aligns the internal circuitry of your handheld with its touch-sensitive screen so that when you tap an element on the screen, the handheld can detect exactly which task you want to perform.

---

**IMPORTANT** Always use the point of the stylus for tapping or making strokes on the handheld screen. Never use an actual pen, pencil, or other sharp object to write on the handheld screen.

---

With your handheld turned on, you can tap the handheld screen to do many operations, such as the following:

- Open applications
- Choose menu commands
- Select options in dialog boxes

Just as you can drag the mouse to select text or move objects on your computer, you can also drag the stylus to select text. You can also use the stylus to drag the slider of any scroll bar.

## Using the navigator

When you work with most applications, the navigator on the front panel of your handheld makes it easy for you to navigate among and select your entries. You can use the navigator to perform tasks without the stylus, using one hand.

See [Chapter 4](#) and [Chapter 5](#) for additional information on using the navigator with Address Book, and [Chapter 8](#) for additional information on using the navigator with Date Book.

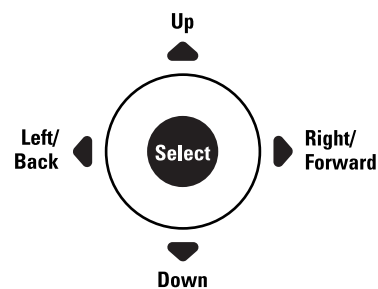

**To navigate in list screens, do any of the following:**

- Press Up or Down on the navigator to scroll an entire screen of records.
- Press and hold Up or Down on the navigator to accelerate the scrolling.
- Press Select on the navigator to insert the selection highlight. When the selection highlight is present, you can do the following:
  - Press Up or Down on the navigator to scroll to the previous or next records.
  - Press Select again to view the selected record.
  - Press Left on the navigator to remove the selection highlight.

**To navigate in record screens:**

1. Press Up or Down on the navigator to scroll within the current record.
2. Press Right or Left on the navigator to scroll to the previous or next record. (This feature is not available in Address Book.)
3. Press Select on the navigator to return to the list screen.

**To navigate in dialog boxes:**

- While a pick list is open, press Up or Down on the navigator to highlight an item, and then press Select on the navigator to select the item.
- Press Select on the navigator to close a dialog box.
  - If there's only one button, pressing Select activates that button.
  - If there are two buttons, pressing Select activates the action button (versus Cancel) such as OK, Yes, or Delete.
  - If there are multiple buttons, Select activates affirming buttons such as OK, Yes, or Done.

---

**IMPORTANT** Read dialog boxes carefully. Sometimes, selecting OK or Yes results in deleting data.

---

## Using the keyboard

You can quickly and accurately enter text or numbers on your handheld using the keyboard. The keyboard also has special function keys that enable you to access features. Another feature is AutoCorrect, which automatically corrects some common misspellings when entering data from the keyboard.

Below the keyboard are application buttons and the 5-way navigator that enables you to navigate menus and pick lists quickly without using the stylus. These features are described in [Chapter 2](#).

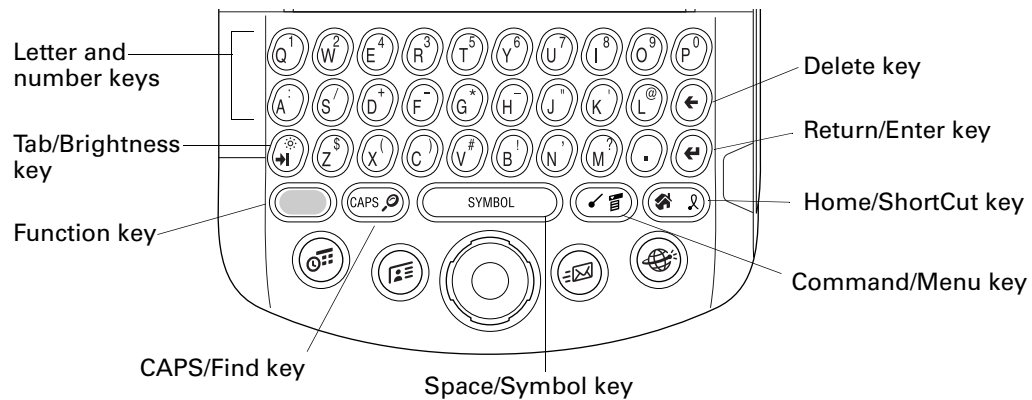

**Letter and number keys:** Enable you to enter letters and numbers. You can change the key response from the Keyboard preferences screen. See [“Keyboard preferences”](#) in [Chapter 18](#).

You can also access international characters using the navigator control. See [“Accessing international and special characters”](#) later in this chapter.



**Tab/Brightness key:** Adds a tab or opens the Brightness dialog box. For more information on the Brightness dialog box, see [“Adjusting the screen brightness level”](#) in [Chapter 2](#).



**Function key:** Press to access the secondary character set. See [“Using the Function key”](#) later in this chapter.



**CAPS/Find key:** Capitalizes letters or opens the Find dialog box. For more information on capitalizing letters, see the next section, [“Typing capital letters.”](#) For information on the Find dialog box, see [“Finding information”](#) in [Chapter 4](#).



**Space/Symbol key:** Adds a space to the text or opens the onscreen keyboards. For more information about the onscreen keyboards, see [“Accessing international and special characters”](#) later in this chapter.



**Command/Menu key:** Opens the Command toolbar or menu. The Command bar has many functions, such as showing the signal strength for the 802.11b radio. For information about the Command mode, see [“Using menu commands and the command toolbar”](#) in [Chapter 4](#). For more information about menus, see [“Using menus”](#) in [Chapter 4](#).



**Home/ShortCut key:** Opens the Application Launcher or enables you to enter a text ShortCut. For more information on ShortCuts, see [“Using ShortCuts”](#) later in this chapter.



**Return/Enter key:** Adds a manual return to the next line or enters the data.



**Delete/Backspace key:** Deletes the previous character.

## Typing capital letters

The keyboard enables you to capitalize letters in two ways:

- Use the CAPS key . Press the CAPS key twice to initiate CAPS lock.
- Press and hold the key. This feature works only when the Keyboard preference repeat function is set to Capital. See [“Keyboard preferences”](#) in [Chapter 18](#) for more information.

## Accessing international and special characters

You can access international and special characters directly from the keyboard or from onscreen keyboards. These character sets enable you to communicate accurately through your memos or wireless messages.

### Accessing from the keyboard

You can access international characters from the keyboard by pressing and holding a key, and then pressing Up and Down on the navigator. The character on the screen scrolls through a sequence of related international characters. You can scroll through the sequence either forward or backward, depending on whether you are pressing Up or Down on the navigator.

**NOTE** This feature does not work with every key or with the Function key secondary character set.

### To use the onscreen keyboard:

1. Open any application (such as Memo Pad).
2. Tap any record, or tap New.

3. Press Function  + Symbol .

When a keyboard is open, you can tap to open any of the other keyboards. When a keyboard is open, you can tap the abc, 123, Int'l, or Sym boxes to open any of the other keyboards, including the international keyboard.

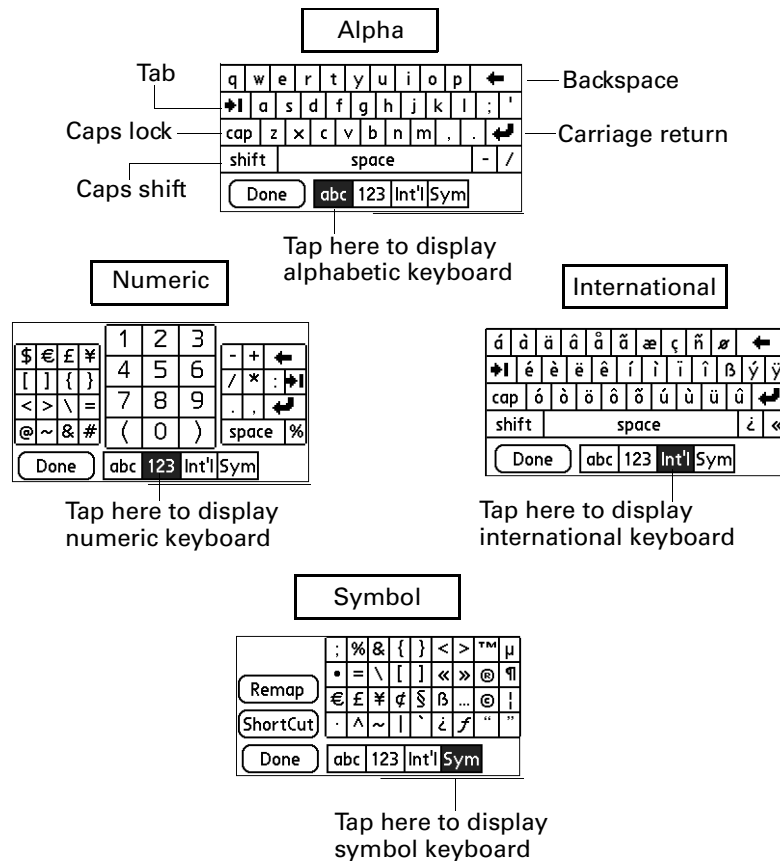



After you finish, tap Done to close the onscreen keyboard and place the text in the record.

### Using the Function key

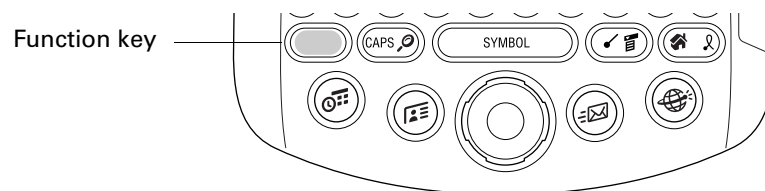
The Function key  enables you to access the secondary character or feature set from each of the keys. The secondary character and feature set is labeled in blue in the upper right on each available key.



When you press Function , the Function active icon appears in the lower-right corner, indicating that the next key pressed will use the secondary character or feature set. If you press the Function  twice, the Function active icon changes to the Function lock icon and the function feature remains locked. Pressing Function  again unlocks it.

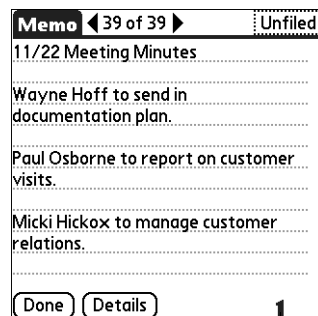

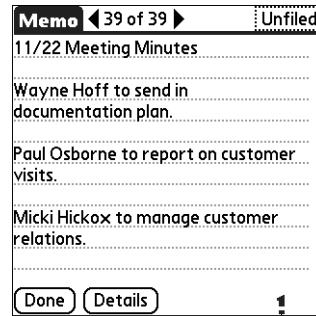

Function active icon



Function lock icon

### Using special features

In addition to characters, the Function key accesses special features on some of the keys. The following keys have special features:

-  **Brightness key:** Opens the Brightness dialog box. See [“Adjusting the screen brightness level”](#) in [Chapter 2](#) for more information.
-  **Find key:** Opens the Find dialog box. See [“Using Find”](#) in [Chapter 4](#) for more information.
-  **Menu key:** Opens the menu for the current screen. For more information, see [“Using menus”](#) in [Chapter 4](#) and see [“Using menu commands and the command toolbar”](#) in [Chapter 4](#).

## Using ShortCuts

ShortCuts make entering commonly used words or phrases quick and easy. ShortCuts are similar to the Glossary or Autotext features of some word processors.

Your handheld comes with several predefined ShortCuts, and you can also create your own. Each ShortCut can represent up to 45 characters. For example, you might create a ShortCut for your name or for the header of a memo. See [“ShortCuts preferences”](#) in [Chapter 18](#) to learn about creating your own ShortCuts.

You can also create security shortcuts that automatically perform security functions. See [“Using security shortcuts”](#) in [Chapter 18](#) for more information.

**To use a ShortCut:**

1. Press Function  + ShortCut .

When you press the ShortCut key, the ShortCut symbol appears at the insertion point to show that you are in ShortCut mode.

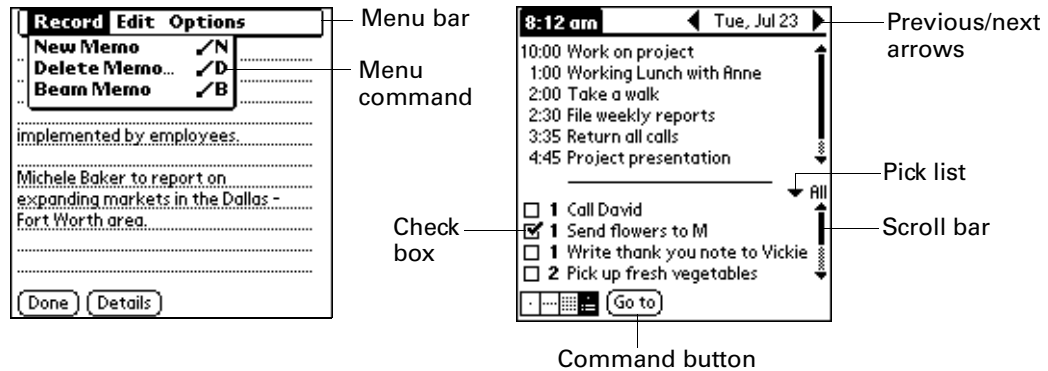

2. Type the ShortCut characters.

## Using elements of the handheld interface

**Menu bar and menu commands**

A set of commands that are specific to the application. Not all applications have a menu bar.

To access the menu bar, do one of the following:

- Tap the Menu bar.
- Press Function  + Menu .

To access the menu commands, do one of the following:

- Tap the menu command on the menu.
- Use Right, Left, Up, or Down on the navigator.
- Press Command Stroke  + the letter. For more information see [“Using menu commands and the command toolbar”](#) in [Chapter 4](#).





**Check box**

When a checkmark appears in a check box, the corresponding option is active.

To insert or remove a checkmark:

- If a check box is empty, tapping it inserts a checkmark.
- If a check box is selected, tapping it removes the checkmark.



- Command buttons** These appear in dialog boxes and at the bottom of application screens.
- To select a command button, do one of the following:
- Tap a button to perform a command.
  - Press Select on the navigator to select a button such as OK, Yes, or Done.
  - Press Function  + Enter  to select the OK, Done, or Yes button.
  - Press Function  + Backspace , to select the Cancel or No button.
- Previous/next arrows** The left and right arrows display the previous and next record; the up and down arrows display the previous and next page of information.
- To use the arrows, do one of the following:
- Tap the arrows.
  - Use Right, Left, Up, or Down on the navigator.
- Pick list** A list of choices that you can select from.
- To use the pick list:
- Tap the arrow to display a list of choices.
  - Tap an item in the list.
  - Use Up or Down on the navigator to scroll through the list and select an item.
- Scroll bar** A bar that enables you to scroll up and down a page.
- To use the scroll bars:
- Drag the slider, or tap the top or bottom arrow, to scroll the display one line at a time.
  - To scroll to the previous page, tap the scroll bar just above the slider. To scroll to the next page, tap the scroll bar just below the slider.
  - You can also scroll to the previous and next pages by pressing Up and Down on the navigator.

### Displaying online tips

Many of the dialog boxes that appear on your handheld contain an online Tips icon in the upper-right corner. Online tips anticipate questions you have about a dialog box, provide shortcuts for using the dialog box, or give you other useful information.

To display an online tip:

1. Tap the Tips icon ⓘ.
2. After you review the tip, tap Done.

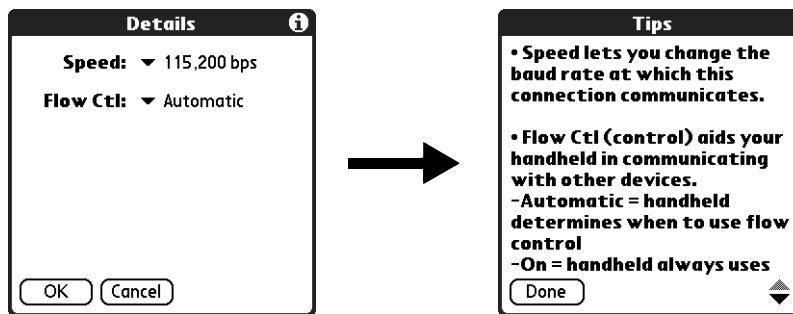

## Using Graffiti 2 writing to enter data

**IMPORTANT** Writing Area preferences must be turned on before you can use Graffiti 2 writing. See [“Writing Area preferences”](#) in [Chapter 18](#) for more information.

In this section you learn to create Graffiti 2 letters, numbers, punctuation, and symbols. You also learn some Graffiti 2 tips and tricks.

Most people find they can enter text quickly and accurately with only minutes of practice. Graffiti 2 writing includes any character you can type on a standard keyboard. The Graffiti 2 characters closely resemble the uppercase letters of the regular alphabet, which makes Graffiti 2 writing easy to learn.

### Activating and deactivating Writing Area preference

When Writing Area preferences are turned on and active, you can write letters anywhere on the left side of the screen, or write numbers anywhere on the right side of the screen. Capital letters are formed in the middle of the screen straddling the imaginary dividing line between the left and right sides. You can also continue to use your keyboard to enter characters.

**To use the full-screen writing area:**

1. Turn on Writing Area Preferences. See [“Writing Area preferences”](#) in [Chapter 18](#) for details.
2. Open the application in which you want to use the full-screen writing area.  
A shaded box appears in the lower-right corner of the screen.
3. Position the cursor where you want the characters to appear.
4. Do any of the following:
  - Write lowercase Graffiti 2 letters anywhere on the left side of the screen.
  - Write numbers anywhere on the right side of the screen.
  - Write uppercase letters in the middle of the screen.
  - Write the Shift stroke before writing symbols and other special characters.
  - Access buttons and other controls that appear on the screen by tapping and holding the control until it activates.

**To temporarily disable the full-screen writing area:**

- Tap the shaded box in the lower-right corner.  
The shaded box changes to a box outline and Writing Area preferences are deactivated.

## Learning Graffiti 2 concepts

There are four basic concepts for success with Graffiti 2 writing:

- If you draw the character shape exactly as shown in the tables later in this chapter (like the shapes shown in the following diagram), you can achieve close to 100 percent accuracy.



- The heavy dot on each shape shows where to begin the stroke. Certain characters have similar shapes but different beginning and end points. Always begin the stroke at the heavy dot. (You should not create the heavy dot; it is there only to show you where to begin the stroke.)
- Graffiti 2 includes symbols made with a single stroke and symbols made with multiple strokes. With some multi-stroke symbols, the first stroke is the same as a single stroke symbol. As a result, the down stroke for the letter “i” cannot be recognized as an “i” at the end of the down stroke. The “i” will not be recognized as an “i” until you enter another symbol that establishes, by its shape or position, that the down stroke was not part of a two-stroke character (such as a “t” or “k”), or until a limited time window expires. Similarly, recognition of a space symbol (a horizontal stroke from left to right) or a period

symbol after a down stroke is dependent upon where the down stroke was drawn.

- The screen is divided into two parts: one for writing lowercase letters and one for writing numbers. Capital letters are formed across the imaginary line that divides the two areas.

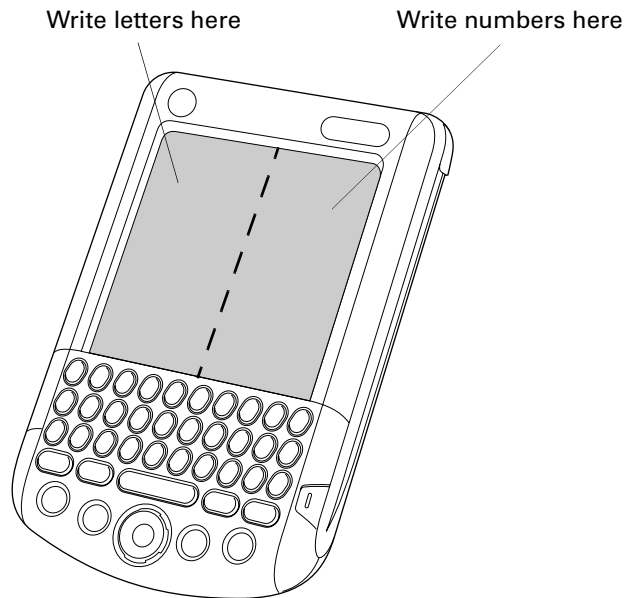

**To write Graffiti 2 characters:**

1. Tap the screen where you want your text to appear.  
You must see a blinking cursor before you write the text.
2. Use the tables on the following pages to find the stroke shape for the letter you want to create. For example, the stroke shown below creates the letter *n*.

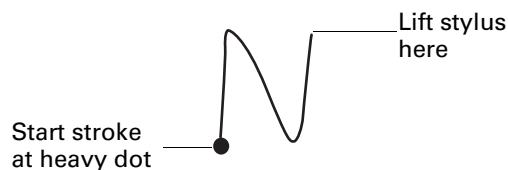

3. Position the stylus in the left side of the screen.
4. Start your stroke at the heavy dot, and draw the stroke shape as it appears in the tables.
5. Lift the stylus from the screen at the end of the stroke shape.

When you lift the stylus from the screen, your handheld recognizes your stroke immediately and prints the letter at the insertion point on the screen.

As soon as you lift the stylus from the screen, you can begin the stroke for the next character you want to write.

**To delete Graffiti 2 characters:**

- Set the insertion point to the right of the character you want to delete and make the backspace stroke.

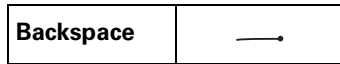



























## Graffiti 2 tips

When using Graffiti 2 writing, keep these tips in mind:

- Accuracy improves when you write large characters. Draw strokes that nearly fill the side of the screen.
- Write at natural speed. Writing too slowly can generate recognition errors.
- Press firmly and do not write on a slant. Vertical strokes should be parallel to the sides of the screen.
- Alternate stroke shapes are available for some characters. You can use the Graffiti 2 Preferences screen to choose the one that's easiest for you. See "[Graffiti 2 Preferences](#)" in [Chapter 18](#) for details.

## Graffiti 2 alphabet

The Graffiti 2 alphabet consists of the following letters:

Draw letters on LEFT side of the screen			
Letter	Strokes	Letter	Strokes
A		B	
C		D	
E		F	
G		H	
I		J	
K		L	
M		N	
O		P	
Q		R	
S		T	
U		V	
W		X	
Y		Z	

## Capital letters

Graffiti 2 writing automatically capitalizes the first letter of a new record or sentence but you can also write additional capital letters.

To write additional capital letters:

- Draw the same stroke shapes used for a lowercase letter, but write across the middle of the screen.

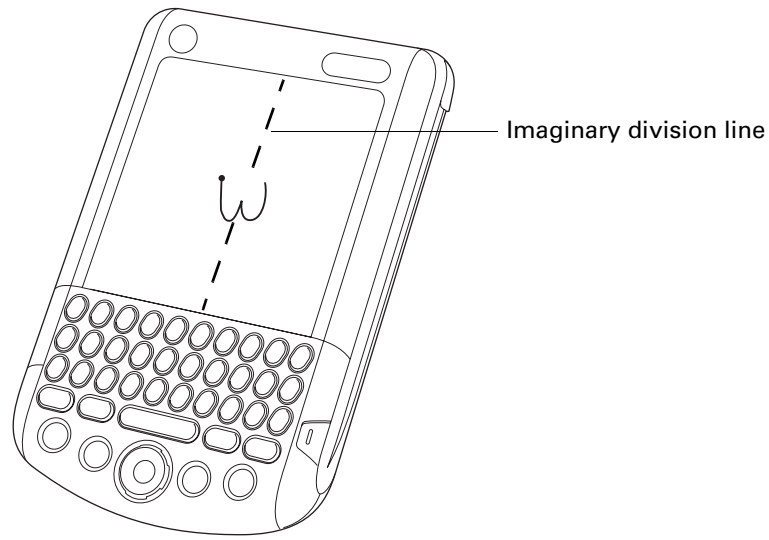











## Graffiti 2 numbers

Writing numbers with Graffiti 2 writing is similar to writing letters of the alphabet, except that you make the character strokes on the right side (numbers side) of the Graffiti 2 writing area.

Draw numbers on RIGHT side of the screen			
Number	Strokes	Number	Strokes
0		1	
2		3	
4		5	
6		7	
8		9	

## Punctuation marks

With Graffiti 2 writing you can create any punctuation mark that you can enter from a standard keyboard. You can write the period and comma strokes on either side of the screen. You must write other punctuation marks on a designated side of the screen. Punctuation marks that appear in the following table must be written on the left (letter) side of the screen.

Draw these marks on LEFT side of the screen			
Mark	Stroke	Mark	Stroke
Period .		Ampersand &	
Comma ,		Carriage return	
Apostrophe '		At @	
Space		Straight quotes "	
Question ?		Tab	
Exclamation !			



Punctuation marks that appear in the following table must be written on the right (number) side of the screen.

Draw these marks on RIGHT side of the screen			
Mark	Stroke	Mark	Stroke
Period .		Backslash \ 	
Comma ,		Slash / 	
Tilde ~		Left Paren ( 	
Dash —		Right Paren ) 	
Plus +		Equal = 	
Asterisk * 			

## Accented characters

When writing letters with accent marks, first write the letter stroke on the left side (or in the center for uppercase letters) of the screen. Then quickly write the accent stroke on the right side of the screen.

You can use the following accent strokes in combination with Graffiti 2 letters:

Draw accents on RIGHT side of screen			
Accent	Stroke	Accent	Stroke
Acute á		Dieresis ä	
Grave à		Circumflex â	
Tilde ã		Ring å	

Using these accent strokes, you can write the following accented letters:

à á â ã ä å è é ê ë ì í î ï ò ó ô õ ö ù ú û ü ý ÿ ñ

## Symbols and other special characters

You can write symbols and other special characters using the Shift stroke.

**NOTE** You can also use the Shift stroke to write punctuation marks.

To write symbols and special characters:

1. Enter the Shift stroke:

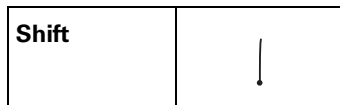

When Shift is active, an up arrow symbol appears in the lower-right corner of the handheld screen. If you accidentally activate Shift, a backspace will cancel it.

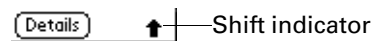

2. Write the symbol or other special character shown in the table that follows. You can make a symbol stroke anywhere on the screen.
3. (Optional) Enter an additional Shift stroke to finish writing the character and to make the character appear more quickly.



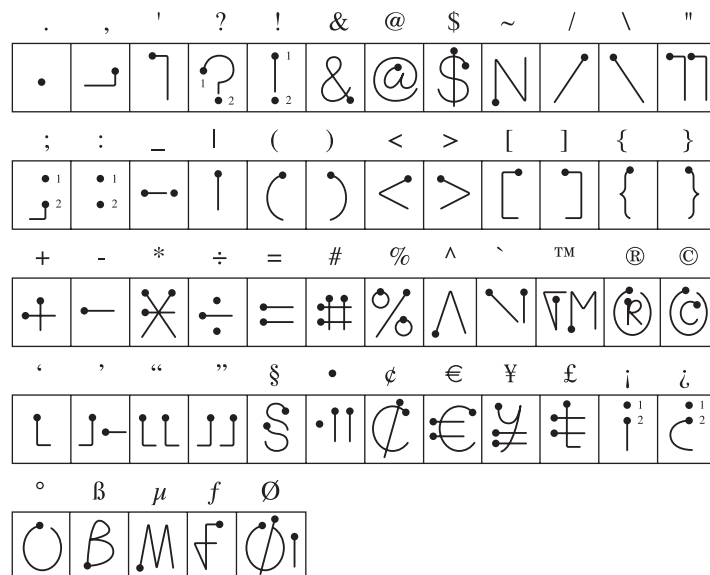

After the arrow disappears, the symbol appears.

**Draw symbols on EITHER side of the screen**



## Graffiti 2 Gestures

Gestures enable you to use editing commands. To use gestures, draw the following strokes on the left (letter) side of the screen:

Draw gestures on LEFT side of the screen				
Gesture	Stroke		Gesture	Stroke
Cut			Paste	
Copy			Undo	

## Graffiti 2 ShortCuts

Graffiti 2 ShortCuts make entering commonly used words or phrases quick and easy. ShortCuts are similar to the Glossary or Autotext features of some word processors.

Graffiti 2 writing comes with several predefined ShortCuts, and you can also create your own. Each ShortCut can represent up to 45 characters. For example, you might create a ShortCut for your name or for the header of a memo. See [“ShortCuts preferences”](#) in [Chapter 18](#) to learn about creating ShortCuts.

To use a ShortCut, draw the ShortCut stroke followed by the ShortCut characters. The ShortCut symbol appears at the insertion point to show that you are in ShortCut mode.

<b>ShortCut</b>	
-----------------	---

Your handheld includes the predefined Graffiti 2 ShortCuts shown in the following table.

<b>Entry</b>	<b>Shortcut</b>
Date Stamp	ds
Time stamp	ts
Date / time stamp	dts
Meeting	me
Breakfast	br
Lunch	lu
Dinner	di

## Beaming data

Your handheld is equipped with an infrared (IR) port that is located at the top of the handheld, behind the small dark shield. The IR port supports the IrCOMM implementation of the standards for infrared communication established by the Infrared Data Association (IrDA). This means that not only can you beam data to another Palm OS® handheld that's close by and is equipped with an IR port, but you can also beam data to a mobile phone and to any other device that supports the IrCOMM implementation of the IrDA standards and that can read the type of data you're beaming.



**NOTE** You cannot beam data between your Tungsten C handheld and a Palm VIIx handheld.

You can beam the following information between devices with an IR port:



- The record currently displayed in Date Book, Address Book, To Do List, Note Pad, Palm Photos, or Memo Pad
- All records of the category currently displayed in Address Book, To Do List, Note Pad, Palm Photos, or Memo Pad
- A special Address Book record that you designate as your business card, containing information you want to exchange with business contacts
- An application installed in RAM memory
- An application installed on an expansion card that is seated in the card slot

**TIP** You can also perform HotSync® operations using the IR port. See [“Conducting IR HotSync operations”](#) in [Chapter 17](#) for details.

**To select a business card:**

1. Create an Address Book record that contains the information you want on your business card.
2. Press Function  + Menu .
3. Select “Select Business Card” on the Record menu.
4. Tap Yes.

**To beam a record, business card, or category of records:**

1. Locate the record, business card, or category you want to beam.
2. Press Function  + Menu .
3. Select one of the following from the Record menu:
  - The Beam command for an individual record
  - In Address Book only: Beam Business Card
  - Beam Category

- When the Beam Status dialog box appears, point the IR port directly at the IR port of the receiving handheld.



For best results, handhelds should be between 10 centimeters (approximately 4 inches) and 1 meter (approximately 39 inches) apart, and the path between the two handhelds must be clear of obstacles. The beaming distance to other Palm OS handhelds may be different.



- Wait for the Beam Status dialog box to indicate that the transfer is complete before you continue working on your handheld.

**TIP** You can also press and hold the Address Book application button to instantly beam your business card to another device with an IR port.

#### To beam an application:

- Press Home .
- Press Function  + Menu .
- Tap App, and then select Beam.
- Select either Handheld or Card from the Beam From pick list.
- Tap the application you want to transfer.

Some applications are copy-protected and cannot be beamed. These are listed with a lock icon next to them.

- Tap Beam.
- When the Beam Status dialog box appears, point the IR port directly at the IR port of the receiving handheld.
- Wait for the Beam Status dialog box to indicate that the transfer is complete before you continue working on your handheld.

#### To receive beamed information:

- Turn on your handheld.
- Point the IR port directly at the IR port of the transmitting handheld to open the Beam dialog box.

3. Select a category for the incoming information, create a new category, or leave the information unfiled.



4. Tap Yes.

## Using your computer keyboard

If you have a lot of data to enter, or prefer to use the computer keyboard, you can use Palm Desktop software or any supported personal information manager (PIM) to enter information. You can then perform a HotSync operation to synchronize the information on your computer with the information on your handheld. Many of the applications that came with your handheld are also available in Palm Desktop software and in most PIMs, so you don't need to learn different applications. For more information on entering data on your computer, refer to the online Help in Palm Desktop software and the *Palm Desktop Software for the Macintosh User's Guide* on the Desktop Software CD-ROM.

## Importing data

If you have data stored in computer applications such as spreadsheets and databases, or if you want to import data from another handheld, you can transfer the data to your handheld without having to enter it manually. Save the data in one of the file formats in the following list, import it into Palm Desktop software, and then perform a HotSync operation to transfer the data to your handheld.

### Importing data from a Windows computer

Palm Desktop software can import data in the following file formats:

- Comma delimited (.csv, .txt): Address Book and Memo Pad only
- Tab delimited (.tab, .tsv, .txt): Address Book and Memo Pad only
- CSV (Lotus Organizer 2.x/97 Mapping): Address Book only
- vCal (.vcs): Date Book only
- vCard (.vcf): Address Book only
- Date Book archive (.dba)
- Address Book archive (.aba)

- To Do List archive (.tda)
- Memo Pad archive (.mpa)

Archive formats can be used only with Palm Desktop software. Use the archive file formats to share information with other people who use a Palm OS handheld or to create a copy of your important Palm Desktop information.

**To import data from a Windows computer:**

1. Open Palm Desktop software.
2. Click the application into which you want to import data.
3. If you are importing records that contain a field with category names, do the following:
  - a. Select All in the Category box.
  - b. Be sure that the same categories that appear in the imported file also exist in the application. If the categories do not exist, create them now; otherwise, the records are imported into the Unfiled category.
4. From the File menu, choose Import.
5. Select the file you want to import.
6. Click Open.

If you are importing a vCal or vCard file, skip to step 10. You do not have to specify which fields correspond to the imported data.

7. To import data into the correct Palm Desktop fields, drag the fields in the left column so that they are opposite the corresponding imported fields on the right.
8. If you do not want to import a field, deselect the check box for that field.
9. Click OK.

The imported data is highlighted in the application.

10. To add the imported data to your handheld, perform a HotSync operation.

See Palm Desktop online Help for more information on importing and exporting data.

## Using File Link

The File Link feature enables you to import Address Book and Memo Pad information to your handheld from a separate external file on your Windows computer, such as a company phone list. You can configure the File Link feature to check for changes to the external file when you perform a HotSync operation. HotSync Manager stores the data in a separate category in Palm Desktop software and on your handheld.

With File Link, you can import data stored in any of the following formats:

- Comma-separated (\*.csv)
- Memo Pad archive (\*.mpa)
- Address Book archive (\*.aba)
- Text (\*.txt)

For information on how to set up a file link, see the Palm Desktop online Help.

## Importing data from a Mac computer

Palm Desktop software can import data from any applications that can export the data in any of the following file formats:

- Tab-delimited file
- Text
- Palm Desktop software for Mac
- vCal (.vcs)
- vCard (.vcf)

For example, you can export tab-delimited files from applications such as: FileMaker Pro, Meeting Maker, Now Contact, and Now Up-to-Date.

**To import data from a Mac computer:**

1. Open Palm Desktop software.
2. From the File menu, choose Import.
3. Select the file you want to import.
4. Click Import.
5. If you want to change the order of the fields you're importing, point to a field, wait for the cursor to change to a double arrow, and then drag the field to a new location.
6. If you do not want to import a field, click the arrow between the field names.
7. From the Fields pop-up menu, choose the appropriate field.
8. From the Delimiters pop-up menu, choose the appropriate delimiter.
9. Click OK.
10. To add the imported data to your handheld, perform a HotSync operation.

See Palm Desktop online Help for more information on importing and exporting data.



# Working with Applications

This chapter explains how to open and switch between applications on your handheld, how to change application settings so they are personalized to your work methods, and how to categorize applications so you view them in related groups.

## Opening applications

You can use the Applications Launcher to open any application installed on your handheld or on an expansion card. You can also open Date Book, Address Book, VersaMail™ application, and PalmSource® Web Browser with the application buttons on your handheld.

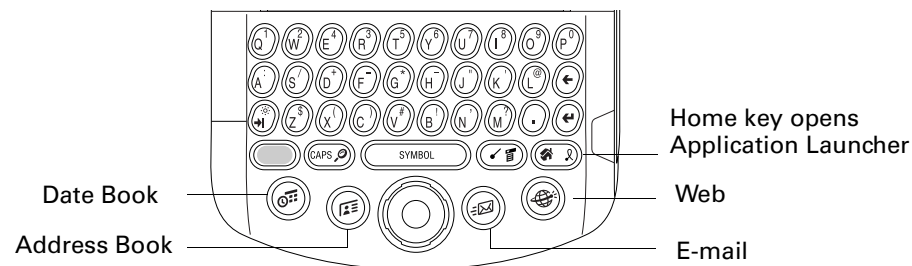

In addition to providing a way for you to open applications, the Applications Launcher displays the current time, battery level, and application category.

### To open an application on your handheld:

1. Press Home (🏠).

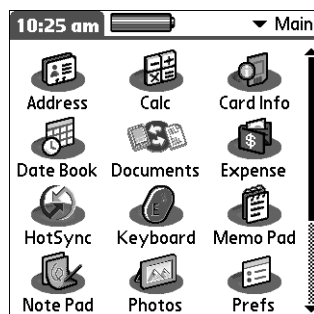

2. Tap the icon of the application that you want to open. If you have many applications installed on your handheld, tap the scroll bar to see all your applications.

## Other ways to open applications

You can also open applications on your handheld in either of the following ways:

- Press and hold Select on the navigator to open the Applications Launcher. Press Select on the navigator to insert the highlight. Press Up, Down, Right, and Left on the navigator to highlight the icon of the application you want to open. Press Select on the navigator to open the application.
- In the Applications Launcher, type the first letter of the application's name. The Applications Launcher scrolls to the first application with a name that begins with that letter and highlights the icon. You can open the icon by pressing the Enter key.

## Opening expansion card applications

When an expansion card is properly seated in the expansion card slot, your handheld responds based on the contents of the card and the application that is active when you insert the card. In some cases, the application on the card opens automatically upon insertion, or if you insert a card containing data from the current application, the application displays the data on the card. In other cases, the Applications Launcher switches to the card and displays its contents, and the pick list in the upper-right corner of the screen displays the name of the card.

**To open an application on an expansion card:**

- Select the icon of the application that you want to open.

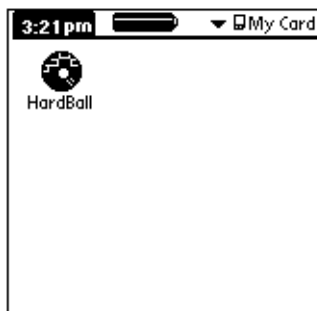

## Switching between applications

When working with any application, press Home (🏠) or press an application button on your handheld to switch to another application. Your handheld automatically saves your work in the current application and displays it when you return to that application.

When you use an expansion card, your handheld creates and displays a new category that matches the name of the expansion card. You can easily switch between applications installed on your handheld and on the expansion card.

**To switch to an expansion card:**

1. Tap the pick list in the upper-right corner.

**TIP** When the highlight in the Applications Launcher is *not* active, you can also press and hold Select on the navigator to open the category pick list.

2. Select the category item that matches the name of the expansion card.

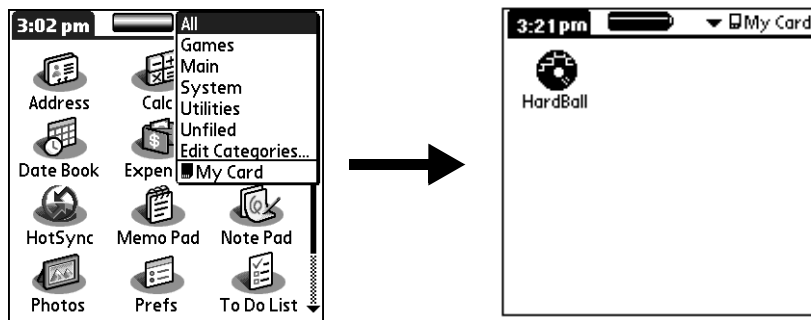

## Categorizing applications





The category feature enables you to manage the number of application icons that appear onscreen in the Applications Launcher. You can assign an application to a category and then display a single category or all your applications.

By default, your handheld includes system-defined categories, such as All and Unfiled, and user-defined categories, such as Games, Main, and System.



You cannot modify the system-defined categories, but you can rename and delete the user-defined categories. In addition, you can create your own user-defined categories. You can have a maximum of 15 user-defined categories.

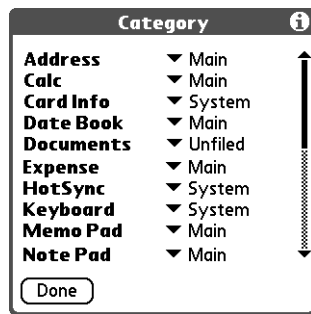

When you have an expansion card properly seated in the expansion card slot, the expansion card name appears as the last item in the category pick list. You can assign applications to the expansion card, but you cannot otherwise categorize applications that reside on an expansion card.

**To categorize an application:**



1. Press Home .
2. Press Command Stroke  + Y.  
Alternately, press Function  + Menu , and then select Category on the App menu.
3. Tap the pick list next to each application to select a category.



**TIP** To create a new category, select Edit Categories from the pick list. Tap New, enter the category name, and then press Function  + Enter , or tap OK to add the category.

4. Press Function  + Enter , or tap Done.







**To display applications by category:**

1. Press Home .
2. Do one of the following:
  - Press Home  repeatedly to cycle through all your categories.
  - Tap the pick list in the upper-right corner of the screen, and select the category you want to display.
  - When the highlight in the Applications Launcher is not active, press and hold Select on the navigator to open the category list, press Up or Down on the navigator to highlight a category, and then press Select on the navigator to display that category.





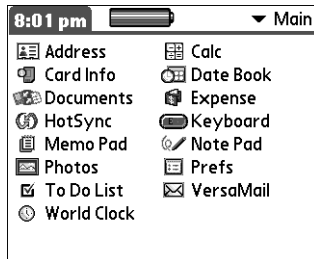

## Changing the Applications Launcher display

By default, the Applications Launcher displays each application as an icon. As an alternative, you can choose to show a list of applications. You can also choose to view the same category of applications each time you open the Applications Launcher.

**To change the Applications Launcher display:**

1. Press Home .
2. Press Command Stroke  + R.  
Alternately, press Function  + Menu , select Options, and then select Preferences.
3. Tap the View By pick list and select List.
4. Press Function  + Enter , or tap OK.

**To open the Applications Launcher to the last opened category:**



1. Press Home .
2. Press Command Stroke  + R.  
Alternately, press Function  + Menu , select Options, and then select Preferences.
3. Tap the Remember Last Category check box to select it.
4. Press Function  + Enter , or tap OK.

## Copying applications to or from an expansion card



You can copy applications from your handheld to an expansion card, or from an expansion card to your handheld.

**To copy an application to an expansion card:**

1. Press Home .
2. Press Command Stroke  + C.

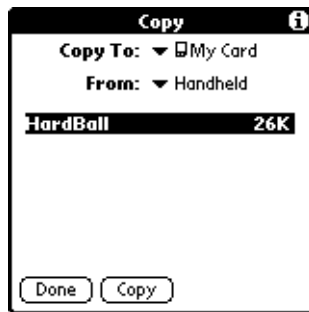
Alternately, press Function  + Menu , and select Copy on the App menu.





3. Select Handheld from the Copy From pick list.
4. Select the card name from the Copy To pick list.  
The Copy To pick list appears only if there are multiple cards available.
5. Tap an application that you want to copy.
6. Tap Copy.
7. Press Function  + Enter , or tap Done.

You can install applications to a card that is seated in the expansion card slot during a HotSync® operation; see [“Installing files and add-on applications”](#) later in this chapter for details.

**NOTE** If you view your applications on the card using a Card Reader on your Windows or Mac computer, the actual file names may differ from those displayed in the Applications Launcher.



#### To copy an application from an expansion card:

1. Press Home .
2. Press Command Stroke  + C.

Alternately, press Function  + Menu , and select Copy on the App menu.



3. Select the card name from the Copy From pick list.

4. Select Handheld from the Copy To pick list.
5. Tap an application that you want to copy.
6. Tap Copy.
7. Press Function  + Enter , or tap Done.



You can also beam applications from expansion cards to your handheld. See [“Using elements of the handheld interface”](#) in [Chapter 3](#) for details.



## Selecting copy settings

When using the copy feature, you can set the following:

- How applications are sorted and listed
- Whether to copy only the application or both the application and its data files



To select copy settings:

1. Press Home .
2. Press Command Stroke  + C.

Alternately, press Function  + Menu , and select Copy on the App menu.

3. Tap Settings.



4. Select Name or Size from the Sort By pick list.
5. Tap the Copy Application Only check box to select it, if you want to copy only the application files. Leave it deselected if you want to copy both the application file and its associated data files.
6. Press Function  + Enter , or tap OK.



**NOTE** The Sort By setting is in effect each time you use the copy feature. Each time you want to copy an application only, you must select the Copy Applications Only check box.

## Using menus

Menus on your handheld are easy to use. Once you have mastered them in one application, you can use them the same way in all other applications.

The menus of each application are illustrated in the chapter that discusses that application.

**To open the menu bar:**

1. Open an application (such as Memo Pad).
2. Do one of the following:
  - Press Function  + Menu .
  - Tap the inverted title area at the top of the screen.

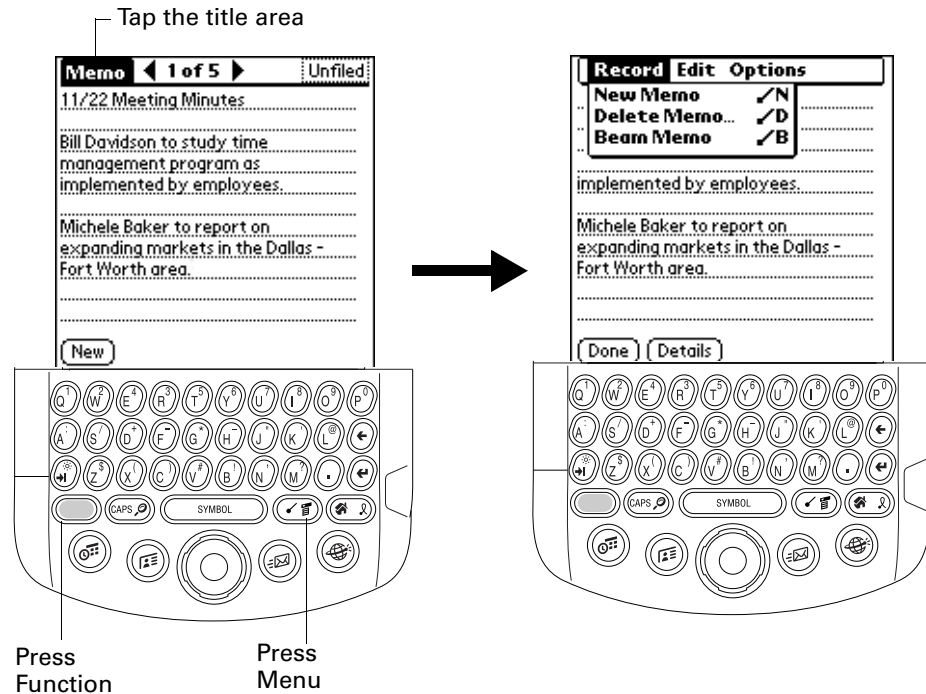

In this example, three menus are available: Record, Edit, and Options. The Record menu is selected and contains the commands New Memo, Delete Memo, and Beam Memo.

**Choosing a menu**

The menus and menu commands that are available depend on the application that is currently open. Also, the menus and menu commands vary depending on which part of the application you're currently using. For example, in Memo Pad the menus are different for the Memo list screen and the Memo record screen.

**To select a menu command with the stylus:**

1. Tap the menu bar for an application.
2. Tap the menu that contains the command you want to use.
3. Tap the command you want to use.

**TIP** After you open the menu bar, you can also press Right and Left on the navigator to select a menu, press Down on the navigator to select the command you want to use, and then press Select on the navigator to run the command.



## Menu commands

Most menu commands have an equivalent Command stroke, which is similar to the keyboard shortcuts used to execute commands on computers. For information on using menu commands, see the next section “Using menu commands and the command toolbar”.

## Using menu commands and the command toolbar

By using the menu commands you can access many functions directly from the keyboard without tapping. You can also view the 802.11b radio signal strength and access the Wi-Fi Preferences screen.

### Using menu commands

Most menu commands have an equivalent Command stroke, which is similar to the keyboard shortcuts used to execute commands on computers. The command letters appear to the right of the command names. For example, to choose Select All in the Edit menu, press Command stroke (⌘) and type the letter s.

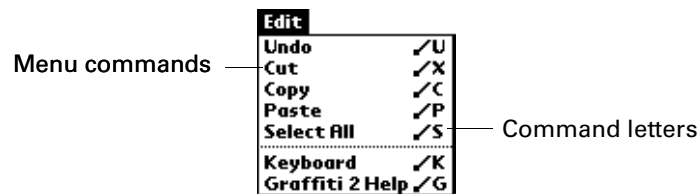

### Using the command toolbar

The command toolbar displays the 802.11b radio signal strength indicator. The command toolbar also displays context-sensitive menu commands for the current screen. For example, if text is selected, the menu icons displayed may be Undo, Cut, Copy, and Paste.

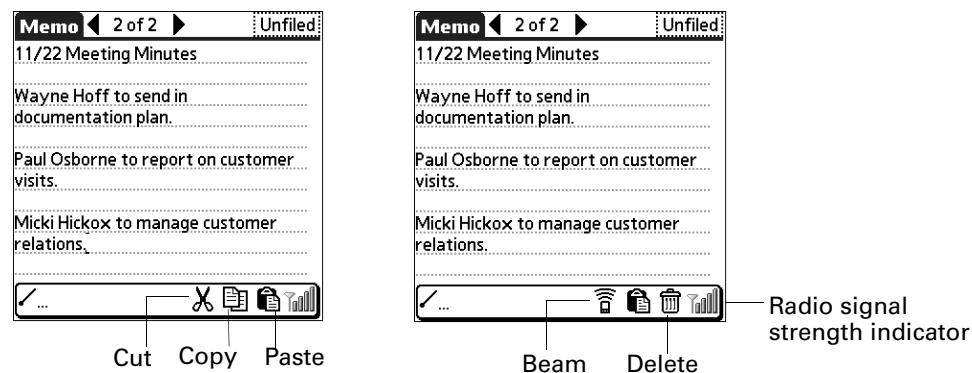

**To use menu commands:**

1. Press Command stroke .

The Command toolbar opens at the bottom of the screen. The Command toolbar indicates that you are in Command mode.

2. Tap an icon or type the command letter immediately to choose the menu command.

Command mode is active only for a short time.

**To access Wi-Fi status:**

1. Press Command stroke .
2. Tap the radio signal strength indicator.

From the Wi-Fi Status dialog box, you can view the network connection and signal strength. You can also tap to access Wi-Fi and VPN preferences.

See “[Wi-Fi preferences](#)” in [Chapter 18](#) and see “[VPN preferences](#)” in [Chapter 18](#) for more information on preferences.

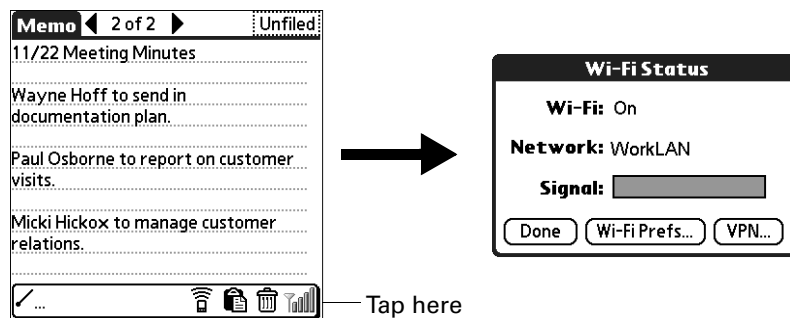



## Choosing application preferences



You can set options that affect an entire application in the application's Preferences dialog box.

**To change preferences for an application:**

1. Open an application.
2. Press Command Stroke  + R.

Alternately, press Function  + Menu , and then select Preferences on the Options menu.

**NOTE** Not all applications have a Preferences command.

3. Make changes to the settings.
4. Press Function  + Enter , or tap OK.





## Performing common tasks

The tasks described in this section use the term *records* to refer to an individual item in any of the applications: a single Date Book event, Address Book entry, To Do List item, Memo Pad memo, Note Pad note, or Expense item.

### Creating records

You can use the following procedure to create a new record in Date Book, Address Book, To Do List, Memo Pad, Note Pad, and Expense.

**To create a record:**

1. Select the application in which you want to create a record.
2. Tap New.
3. In Date Book only: Select start and end times for your appointment, and press Function  + Enter , or tap OK.
4. Enter text for the record.
5. (Optional) Tap Details to select attributes for the record. (In Note Pad the Details command is located on the Options menu.)
6. In Address Book, Note Pad, and Memo Pad only: Press Function  + Enter , or tap Done.

There's no need to save the record, because your handheld saves it automatically.

### Editing records

After you create a record, you can change, delete, or enter new text at any time. Two screen features tell you when your handheld is in editing mode:

- A blinking cursor
- One or more dotted edit lines

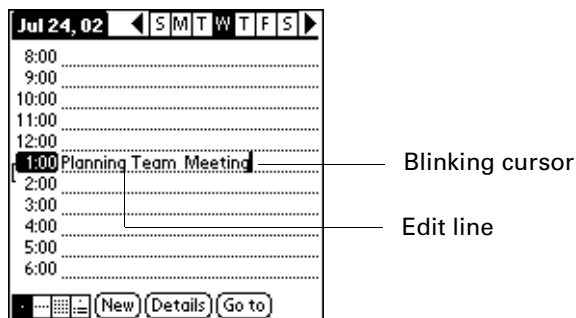

**NOTE** In Note Pad you can write anywhere on the screen. Therefore, you will not see an edit line or blinking cursor unless the cursor is in the title line.

### Entering text

For information on how to enter text using the keyboard on your handheld or the keyboard attached to your computer, see [Chapter 3](#). For information on entering text in Note Pad, see [Chapter 11](#).

### Using the Edit menu



The Edit menu is available with any screen where you enter or edit text. In general, commands available in the Edit menu apply to text that you *select* in an application.

#### To select text in an application:

1. Tap the beginning of the text that you want to select.
2. Drag the stylus over the text to highlight it (in yellow).

**NOTE** You can also double-tap to select a word, or triple-tap to select a line of text. You can also drag *across* the text to select additional words, or drag *down* to select a group of lines.

The following commands may appear in an Edit menu:



<b>Undo</b>	Reverses the action of the <i>last edit</i> command. For example, if you used Cut to remove text, Undo restores the text you removed. Undo also reverses deletions you made using the backspace.
<b>Cut</b>	Removes the selected text and stores it temporarily in the memory of your handheld. You can paste the text you cut into another area of the current application or into a different application.
<b>Copy</b>	Copies the selected text and stores it temporarily in the memory of your handheld. You can paste the copied text into another area of the current application or into a different application.
<b>Paste</b>	Inserts the cut or copied text at the selected point in a record. The text you paste replaces any selected text. If you did not previously cut or copy text, Paste does nothing.
<b>Select All</b>	Selects all the text in the current record or screen. This enables you to cut or copy all of the text and paste it elsewhere.
<b>Keyboard</b>	Opens the onscreen keyboard. After you finish with the onscreen keyboard, press Function  + Enter  , or tap Done.

## Deleting records

To delete a record using the menu command:

1. Select the record you want to delete.
2. Press Command Stroke  + D.

To delete a record using the Menu:

1. Select the record you want to delete.
2. Press Function  + Menu .
3. Select Record, and then select one of the following Delete commands:

**Date Book:** Delete Event

**Address Book:** Delete Address



**To Do List:** Delete Item

**Note Pad:** Delete Note

**Memo Pad:** Delete Memo

**Expense:** Delete Item



A confirmation dialog box appears. If you want to save a copy of the deleted item to an archive file in Palm™ Desktop software, be sure that the check box is selected. If you don't want to save a copy, tap the check box to deselect it.

4. Press Function  + Enter , or tap OK.

If you choose to save a copy of the selected item, your handheld transfers it to the archive file on your desktop the next time you perform a HotSync operation. (The archive option is not available in Note Pad.)

### Other ways to delete records

You can also delete records in the following ways:

- Delete the text of the record.
- In Date Book, Address Book, To Do List, and Memo Pad, open the Details dialog box for the record, tap Delete, and then press Function  + Enter , or tap OK.

**NOTE** When deleting a repeating event in Date Book, you can choose to delete the current repeating event, current and future events, or all instances of that event.

- In Note Pad, open the note you want to delete, and then tap Delete.

## Purging records

Over time, as you use Date Book, To Do List, and Expense, you'll accumulate records that have outlived their usefulness. For example, events that occurred months ago remain in the Date Book, and To Do List items that you marked as completed remain in the list, as do Expense items.

All these outdated records take up memory on your handheld, so it's a good idea to remove them by using Purge. If you think Date Book or To Do List records might prove useful later, you can purge them from your handheld and save them in an archive file on your computer.

Purging is not available in Address Book, Note Pad, or Memo Pad; you must delete outdated records manually from these applications.

### To purge records:

1. Open the application.
2. Press Command Stroke  + E.

Alternately, press Function  + Menu , and then select Purge on the Record menu.

A confirmation dialog box appears.

**Date Book:** Tap the pick list and select how old a record must be to be purged. Purge deletes repeating events if the last of the series ends before the date that you purge records.

**Date Book, To Do List:** If you want to save a copy of the purged records to an archive file on your desktop, be sure that the check box is selected. If you don't want to save a copy, tap the check box to deselect it.

**Expense:** Select the category you want to purge. All data in the selected category will be purged, and there is no archive option.

3. Press Function  + Enter , or tap OK or Done.

If you chose to save a copy of the purged records, your handheld transfers them to an archive file on your desktop the next time you perform a HotSync operation.

**NOTE** Purging does not happen automatically. You must select the command to make it happen.

## Categorizing records

You can categorize records in the Address Book, To Do List, Note Pad, Memo Pad, and Expense applications so that they are grouped logically and are easy to review.

When you create a record, your handheld automatically places it in the category that is currently displayed. If the category is All, your handheld assigns it to the Unfiled category. You can leave an entry as Unfiled or assign it to a category at any time.

By default, your handheld includes system-defined categories, such as All and Unfiled, and user-defined categories, such as Business and Personal.

You cannot modify the system-defined categories, but you can rename and delete the user-defined categories. In addition, you can create your own user-defined categories. You can have a maximum of 15 user-defined categories in each application.

When you have an expansion card properly seated in the expansion card slot, the last item in the category pick list is the name of the expansion card. You cannot otherwise categorize applications that reside on an expansion card.

Address Book contains the QuickList user-defined category, in which you can store the names, addresses, and phone numbers you might need in emergencies (doctor, fire department, lawyer, and so on).



Expense contains two user-defined categories, New York and Paris, to show how you might sort your expenses according to different business trips.

The illustrations in this section come from Address Book, but you can use these procedures in all the applications in which categories are available.

**To move a record into a category:**

1. Select the record you want to categorize.
2. In Address Book only: Tap Edit.
3. Tap Details.
4. Tap the Category pick list to display the list of available categories.



5. Select the category for the record.
6. Press Function  + Enter , or tap OK.

**NOTE** In Address Book, Note Pad, and Memo Pad you can select the category name in the upper-right corner of the screen to assign the item to a different category.

**To display a category of records:**

1. Tap the category pick list in the upper-right corner of the list screen.

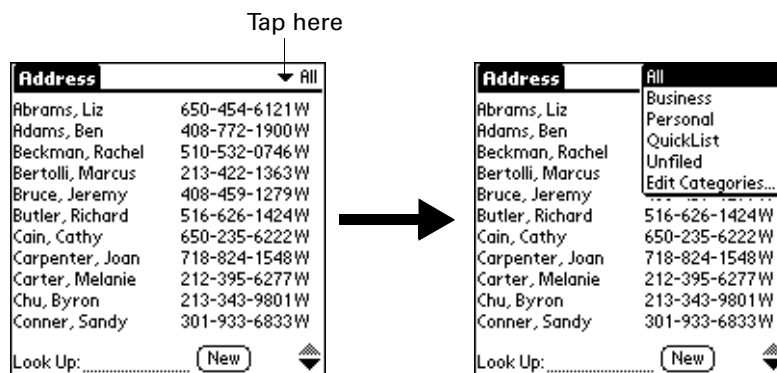

**NOTE** In the Date Book Agenda view, the pick list is in the upper right of the To Do list.

2. Select the category you want to view.

The list screen now displays only the records assigned to that category.

**TIP** Pressing an application button on your handheld scrolls through all the categories of that application except for Unfiled. This feature is not available in Date Book.

**To define a new category:**

1. Tap the category pick list in the upper-right corner of the screen or list.

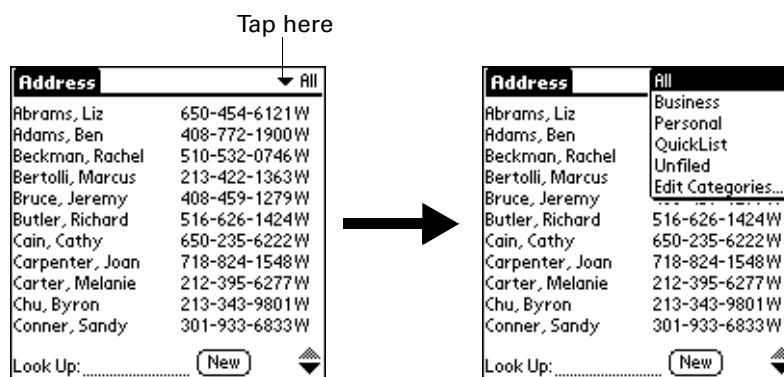



2. Select Edit Categories.





3. Tap New.



4. Enter the name of the new category, and then press Function  + Enter , or tap OK.





5. Press Function  + Enter , or tap OK.

You can assign any of your records to the new category.



#### To rename a category:

1. Tap the category pick list in the upper-right corner of the screen or list.
2. Select Edit Categories.
3. Select the category that you want to rename, and then tap Rename.



4. Enter the new name for the category, and then press Function  + Enter , or tap OK.



5. Press Function  + Enter , or tap OK.

**TIP** You can group the records from two or more categories into one category by giving the categories the same name. For example, if you change the name of the Personal category to Business, all records formerly in the Personal category appear in the Business category.

## Finding information

Your handheld offers several ways to find information quickly:

- **All applications that reside on your handheld:** Find locates any text that you specify, always starting with the current application. However, Find does not search through applications on expansion cards.
- **Date Book, To Do List, Memo Pad:** Phone Lookup displays the Address list screen and enables you to add to a record the information that appears in this list.
- **Address Book:** The Look Up line enables you to scroll immediately to a name when you enter the first letters of that name.
- **Expense:** Lookup displays the names in your Address Book that have data in the Company field. You can add these names to a list of attendees associated with an Expense record.

### Looking up Address Book records

In Address Book, you can use the Look Up line with the stylus or the navigator to look up and quickly scroll to any of your Address Book entries.

To look up an Address Book record with the stylus:

1. From the Address list screen, enter the first letter of the name you want to find.

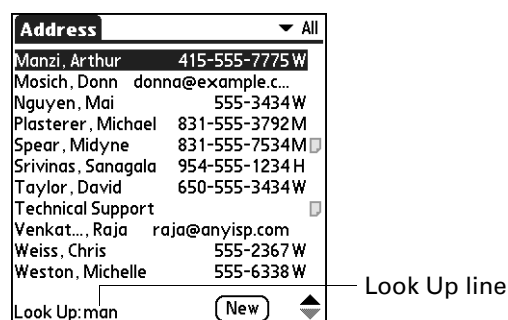

The list scrolls to the first entry that begins with that letter. If you write another letter, the list scrolls to the first entry that starts with those *two* letters. For example, writing an *s* scrolls to “Sands,” and writing *sm* scrolls further to “Smith.” If you sort the list by company name, the Look Up feature scrolls to the first letter of the company name.

2. Tap the record to view its contents.

**To look up an Address Book record with the navigator:**

1. From the Address List screen, press Right on the navigator to display the navigator Quick Look Up line.
2. Press Up or Down on the navigator to select the first letter of the name you want to find.

The list scrolls to the first entry that begins with that letter.

3. Press Right on the navigator to move to the next letter box.

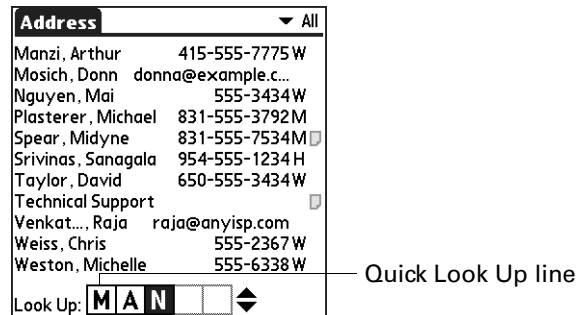

The Quick Look Up line displays only letters that are a possible match for that position.

If only one match is possible for a particular position, the highlight jumps to the next position.

4. Press Up or Down on the navigator to select the next letter of the name you want to find.

The list then scrolls to the first entry that starts with those *two* letters. For example, selecting *s* scrolls to “Sands,” and selecting *sm* scrolls further to “Smith.” If you sort the list by company name, the Quick Look Up feature scrolls to the matches for the company name.



5. Repeat steps 3 and 4 until the entry you want appears in the list.
6. Press Select on the navigator to highlight the record you want.
7. Press Select on the navigator to view the contents of the selected record.

**TIP** If only one match is possible for the letters you selected, the contents of the record displays automatically.

**Using Find**

You can use Find to locate any text that you specify, in any application that resides on your handheld. Find does not search applications that reside on an expansion card.

**To use Find:**



1. Press Function  + Find .

**TIP** If you select text in an application before you tap Find, the selected text automatically appears in the Find dialog box.

2. Enter the text that you want to find.

Find is not case-sensitive. For example, searching for the name “davidson” also finds “Davidson.”

Find locates any words that begin with the text you enter. For example, searching for “plane” finds “planet” but not “airplane.”

3. Press Function  + Enter , or tap OK.

Find searches for the text in all records and all notes.

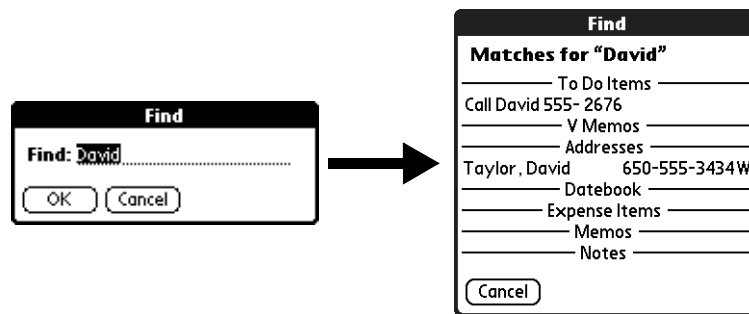

As your handheld searches for the text, you can tap Stop at any time. You may want to do this if the entry you want appears before your handheld finishes the search. To continue the search after you tap Stop, tap Find More.



4. Tap the text that you want to review.

**Using Phone Lookup**

Phone Lookup displays the Address list screen and enables you to add to a record the information that appears in this list.

**To use Phone Lookup:**

1. Display the record in which you want to insert a phone number. The record can be in Date Book, To Do List, Memo Pad, or any other application that takes advantage of this feature.
2. Press Command Stroke  + L.

Alternately, press Function  + Menu , and then select Phone Lookup on the Options menu.

3. Begin to spell the last name of the name you want to find.

The list scrolls to the first record in the list that starts with the first letter you enter. Continue to spell the name you're looking for, or when you see the name, tap it.

Phone Number Lookup:	
Abrams, Liz	650-454-6121W
Adams, Ben	408-772-1900W
Beckman, Rachel	510-532-0746W
Bertolli, Marcus	213-422-1363W
Bruce, Jeremy	408-459-1279W
Butler, Richard	516-626-1424W
Cain, Cathy	650-235-6222W
<b>Carpenter, Joan</b>	<b>718-824-1548W</b>
Carter, Melanie	212-395-6277W
Chu, Byron	213-343-9801W
Conner, Sandy	301-933-6833W

Look Up: car .....   ▼

4. Tap Add.

The name you selected, along with the other information associated with it, is pasted into the record you selected in step 1.

### Looking up names to add to Expense records

In Expense, Lookup displays the names in your Address Book that have data in the Company field. You can add these names to a list of attendees associated with an Expense record.

To add names to an Expense record:

1. Tap the Expense record to which you want to add names.
2. Tap Details.

Receipt Details	
Category:	▼ Unfiled
Type:	▼ Lunch
Payment:	▼ Unfiled
Currency:	▼ \$
Vendor:	.....
City:	.....
Attendees:	Who: .....

↑

3. Tap Who.

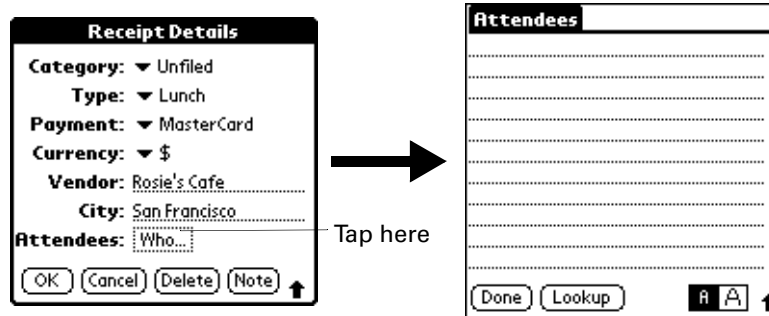



4. Tap Lookup.

The Attendees Lookup screen displays all the names in your Address Book that have data in the Company field.

5. Select the name you want to add, and then tap Add.

The name appears in the Attendees screen.

6. Repeat steps 4 and 5 to add more names.
7. Press Function  + Enter , or tap Done.
8. Press Function  + Enter , or tap OK.



## Sorting lists of records

You can sort lists of records in various ways, depending on the application. Sorting is available in applications that have list screens: Address Book, Note Pad, To Do List, Memo Pad, and Expense.

**NOTE** You can also assign records to categories. See [“Categorizing records”](#) earlier in this chapter.

**To sort records in Address Book, Note Pad, and Memo Pad:**

1. Open the application to display the list screen.
2. Press Command Stroke  + R.

Alternately, press Function  + Menu , and then select Preferences on the Options menu.

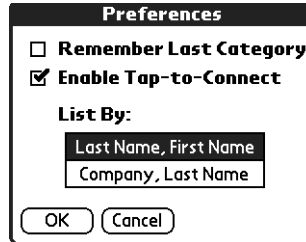
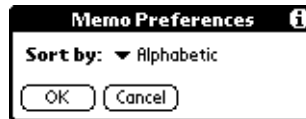

**Address Book****Note Pad****Memo Pad**

3. Do one of the following:

**Address Book:** Tap the setting you want.

**Note Pad:** Tap the Sort by pick list and select Alphabetic, Date, or Manual.



**Memo Pad:** Tap the Sort by pick list and select Alphabetic or Manual.

4. Press Function  + Enter , or tap OK.

To sort the Note Pad and Memo list manually, tap and drag a note or memo to a new location in the list.

To make the list appear in Palm Desktop software as you manually sorted it on your handheld, open the application in Palm Desktop software and click Sort by. Then select Order on Handheld.

**To sort records in To Do List and Expense:**

1. Open the application to display the list screen.
2. Tap Show.
3. Tap the Sort by pick list and select an option.
4. Press Function  + Enter , or tap OK.

## Attaching notes

In Address Book, Date Book, To Do List, and Expense, you can attach a note to a record. A note can be up to several thousand characters long. For example, for an appointment in Date Book, you can attach a note with directions to the location.

### To attach a note to a record:

1. Display the entry to which you want to add a note.



To display an entry, tap it or press Up or Down on the navigator to highlight it, and then press Select on the navigator.

2. In Address Book only: Tap Edit.

3. Tap Details.

4. Tap Note.

5. Enter your note.

6. Press Function  + Enter , or tap Done.

A small note icon appears at the right side of any item that has a note.

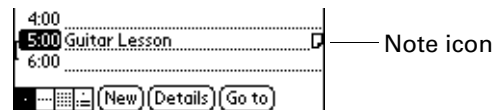

### To review or edit a note:



- Tap the Note icon .

**TIP** In Date Book, you can also select the event that contains the note, press Select on the navigator to open the note, and then press Select on the navigator again to close the note.

### To delete a note:

1. Tap the Note icon .

2. Tap Delete.

3. Press Function  + Enter , or tap Yes.



## Choosing fonts

In many applications, you can change the font style to make text easier to read. You can choose small, small bold, large, or large bold fonts in each application that enables you to change font style.

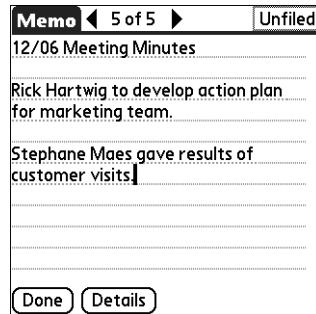

Small font



Small bold font

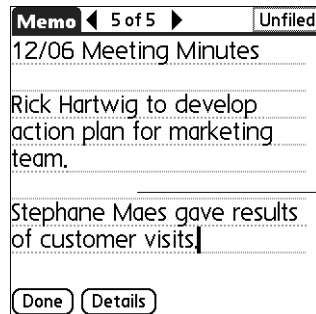

Large font

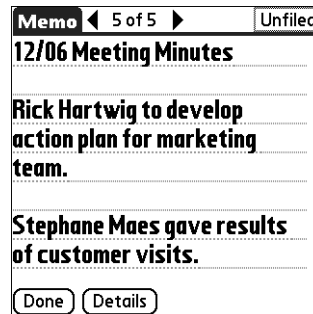

Large bold font



### To change the font style:

1. Open an application.
2. Press Command Stroke  + F.

Alternately, press Function  + Menu , and then select Font on the Options menu.

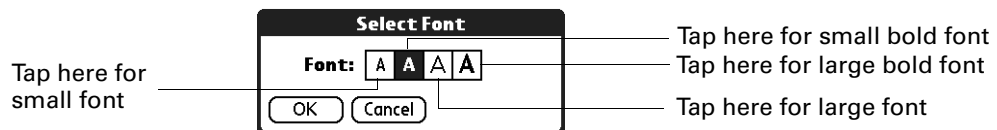
3. Tap the font style you want to use.



4. Press Function  + Enter , or tap OK.

## Receiving alerts

You can receive alerts on your handheld and in Palm Desktop software.

### Receiving alerts on your handheld



When you use certain application settings, your handheld can alert you to any of the following:

- An appointment set in Date Book
- A note created in Note Pad
- An alarm set in World Clock

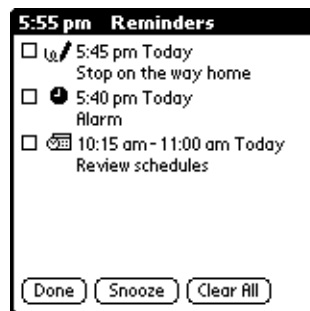
When an alert occurs, your handheld displays a reminder message. If you tap Snooze in response to an alert message, your handheld reminds you of the item again in five minutes. The Reminders screen displays alerts that await attention.



To respond to alerts, do one of the following:

- Select an item's check box to clear the item.
- Tap an item (either the icon or the text description) to open the application where the alarm was set. The application opens to the entry associated with the alarm.
- Press Function  + Enter , or tap Done to close the reminder list and return to the current screen. An attention indicator blinks in the upper-left corner of the screen; tap it to view the alert list again.
- Tap Snooze to see the list again in five minutes.

If you tap Done or Snooze and view the reminder list later, the current time is displayed in the Reminder bar and the original alert time is displayed with each list item.

- Tap Clear All to dismiss all alerts in the list.

### Receiving alerts from Palm Desktop software

You can also set an option to receive Date Book event alerts from Palm Desktop software. The feature is disabled by default, so you must enable it within Palm Desktop software.

To enable an event alert from Palm Desktop software:

1. Double-click the Palm Desktop icon.
2. From the Tools menu, select Options, and then select Alarms.
3. Set Alarm Configuration options, either Always Available or Available only when the Palm Desktop is running.
4. (Optional) To hear an alert sound as well as receive an alert message, select the check box Play audible notification with alarm dialog.
5. Click OK.

### Hiding or masking private records

You can use the Security preferences to set a password and select whether to mask your private records or hide them completely. See [“Security preferences”](#) in [Chapter 18](#) for details.

## Installing and removing applications

This section explains how to install and remove applications and other files on your handheld or on an expansion card, and how to remove Palm Desktop software from your computer.

### Installing files and add-on applications

Your handheld comes with many applications installed and ready to use. During a HotSync operation you can also install additional applications, such as games and other software, on your handheld or on a card that is seated in the expansion card slot. Applications or games that you install on your handheld reside in RAM memory, and you can delete them at any time.

You can also install other files that are associated with an application on your handheld, such as photos. Files that are not associated with an application on your handheld may not be installed during a HotSync operation.

Both applications and files are easy to install during a HotSync operation. You can install the following types of files:

- Palm file types, including PRC and PDB
- Image files, including BMP and JPEG
- Kinoma video files (requires the Kinoma application from the Software Essentials CD-ROM)

There are a variety of third-party applications available for your handheld. To learn more about these applications, go to the web site: [www.palm.com](http://www.palm.com).

**NOTE** Palm works with developers of third-party add-on applications to ensure the compatibility of these applications with your new Palm handheld. Some third-party applications, however, may not have been upgraded to be compatible with your new Palm handheld. If you suspect that a third-party application is adversely affecting the operation of your handheld, contact the developer of the application.

## Installing applications and files on a Windows computer

Palm Quick Install makes it easy to install applications and files during the next HotSync operation. You can even install compatible files directly from a Zip file. Depending on the file type, Palm Quick Install determines whether to install the files on your handheld or on an expansion card.

You can use any of the following methods to install applications and files with Palm Quick Install:

- Drag and drop files onto the Palm Quick Install icon on the Windows desktop.
- Drag and drop files onto the Palm Quick Install window.
- Use the commands or buttons in the Palm Quick Install window.
- Right-click a file and send it to Palm Quick Install.

The procedures that follow explain how to install applications and files using each of these methods.

### To drag and drop applications or files onto the Palm Quick Install icon:

1. Copy or download the application(s) or file(s) you want to install onto your computer.
2. From My Computer or Windows Explorer, select the file(s) or folder that you want to install.
3. Drag and drop the file(s) or folder onto the Palm Quick Install icon on the Windows desktop.



Palm Quick Install displays a confirmation dialog box that shows whether the files will be installed on your handheld or on an expansion card, and you can choose the user name to which the files will be installed.

4. Click OK.

The selected files are placed in the Handheld or Expansion Card file list, based on the file extension.

- Perform a HotSync operation to install the files. See [“Performing cradle/cable HotSync operations”](#) in [Chapter 17](#) for details.

**NOTE** Files that remain in the list after you perform a HotSync operation were not installed. This can happen if the file type was not recognized during the HotSync operation. If files are unrecognized, try launching the associated application from your handheld and then performing another HotSync operation. If the files still remain in the list, they are not associated with an application on your handheld and cannot be installed. Expansion cards may also hold files that are not Palm application files.

To drag and drop applications or files onto the Palm Quick Install window:

- Copy or download the application(s) or file(s) you want to install onto your computer.
- Double-click the Palm Quick Install icon on the Windows desktop.

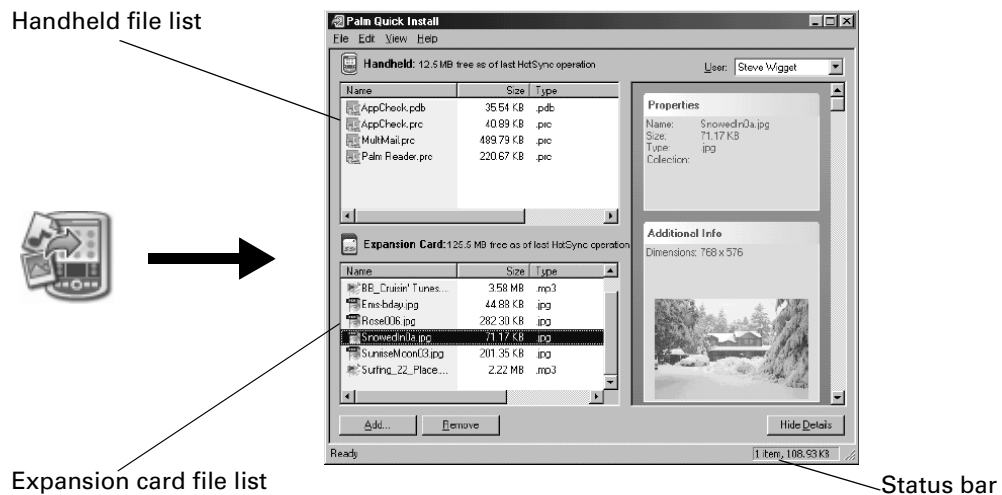

- From My Computer or Windows Explorer, select the file(s) or folder that you want to install.
- Drag and drop the file(s) or folder onto the handheld or expansion card file list.

If a No symbol appears when you attempt to drag a file onto a file list, that file is not supported on that destination.

The status bar shows the number of files selected and their total size. However since some file types are compressed during synchronization they may actually require less space than the amount shown in the file size column or status bar.

5. Perform a HotSync operation to install the files. See “Performing cradle/cable HotSync operations” in Chapter 17 for details.

**NOTE** Files that remain in the list after you perform a HotSync operation were not installed. This can happen if the file type was not recognized during the HotSync operation. If files are unrecognized, try launching the associated application from your handheld and then performing another HotSync operation. If the files still remain in the list, they are not associated with an application on your handheld and cannot be installed. Expansion cards may also hold files that are not Palm application files.

To use the command buttons in the Palm Quick Install window:

1. Copy or download the application(s) or file(s) you want to install onto your computer.
2. Double-click the Palm Quick Install icon on the Windows desktop.

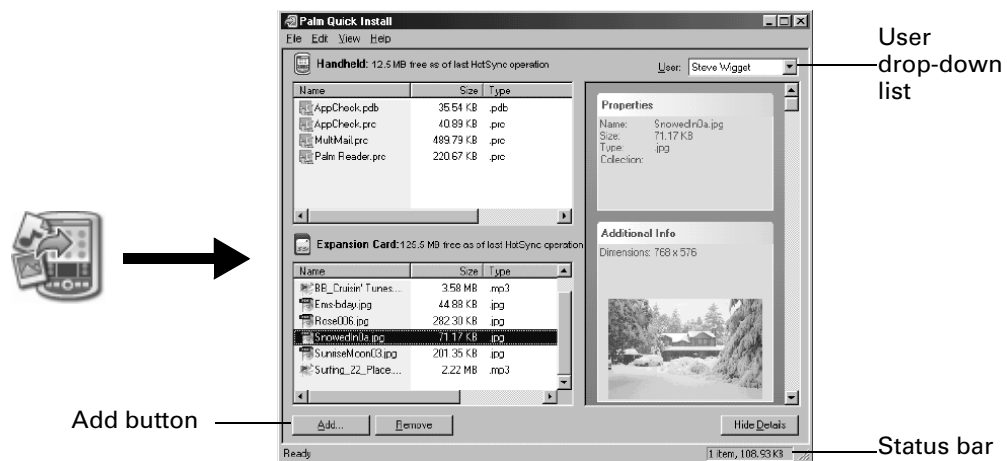

3. In the User drop-down list, select the name that corresponds to your handheld.
4. Click Add.

**TIP** To install a folder, open the File menu and select Add Folder.

5. Select the application(s) or file(s) that you want to install.

If you do not see the application(s) or file(s) in the default folder, navigate to the folder that contains the application(s) or file(s) that you want to install.

6. Click OK.

7. If you need to change the destination of the application you are installing, drag the files to move applications between the handheld and expansion card file list.

The status bar shows the number of files selected and their total size. However since some file types are compressed during synchronization they may actually require less space than the amount shown in the file size column or status bar.

8. Perform a HotSync operation to install the selected application(s). See [“Performing cradle/cable HotSync operations”](#) in [Chapter 17](#) for details.

**NOTE** Files that remain in the list after you perform a HotSync operation were not installed. This can happen if the file type was not recognized during the HotSync operation. If files are unrecognized, try launching the associated application from your handheld and then performing another HotSync operation. If the files still remain in the list, they are not associated with an application on your handheld and cannot be installed. Expansion cards may also hold files that are not Palm application files.

**To use the right-click menu to send the file to Palm Quick Install:**

1. Copy or download the application(s) or file(s) you want to install onto your computer.
2. From My Computer or Windows Explorer, right-click the file(s) or folder that you want to install.
3. Select Send To and then select Palm Quick Install.

Palm Quick Install displays a confirmation dialog box that shows whether the files will be installed on your handheld or on an expansion card.

4. Click OK.

The selected files are placed in the Handheld or Expansion Card file list, based on the file extension.

5. Perform a HotSync operation to install the files. See [“Performing cradle/cable HotSync operations”](#) in [Chapter 17](#) for details.

Any unrecognized files are not installed.

## Palm Quick Install Tips

The following tips can help you use Palm Quick Install most effectively:

- By default video files are placed in the expansion card file list. If you prefer to store these files on your handheld you can move them to the handheld file list.
- When you drag and drop a folder, Palm Quick Install looks at files in the first level of subfolders only; it does not look at folders nested inside the subfolders.
- To install files in a different location, start Palm Quick Install and drag the files to a different file list.
- You can also access the Palm Quick Install window by clicking Quick Install on the Palm Desktop Launch bar.

## Installing applications and files on a Mac computer

The Install Tool makes it easy to install applications and files during a HotSync operation. You can specify whether to install the files on your handheld or on an expansion card.

**To install add-on software on your handheld using a Mac computer:**

1. On your Mac computer, copy or download the application you want to install into the Add-on folder in your Palm folder.
2. Double-click the HotSync Manager icon in the Palm folder.
3. From the HotSync menu, select Install Handheld Files.
4. From the User pop-up menu, select the name that corresponds to your handheld.

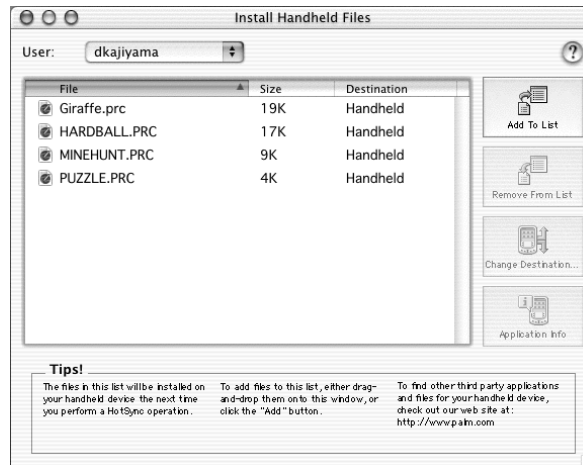

5. Click Add To List.

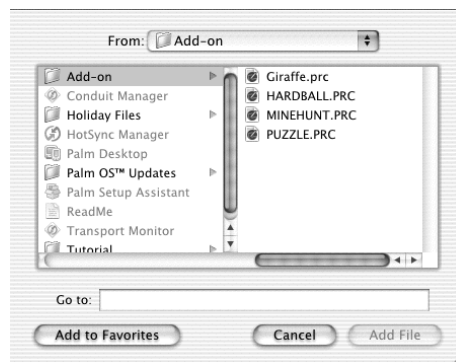

If the file you want to install is not listed in the dialog box, go to the folder to which you copied the file. Most handheld application files have the extension PRC or PDB.

6. Select the application(s) you want to install.
7. Click Add File to add the selected application to the Install Handheld Files list.

**TIP** You can also drag files, or folders of files, to the list in the Install Handheld Files dialog box. The files are copied to the Files To Install folder.



- If you need to change the destination of the application you are installing, click Change Destination in the Install Handheld Files window, and then use the arrows to move applications between your handheld and an expansion card.

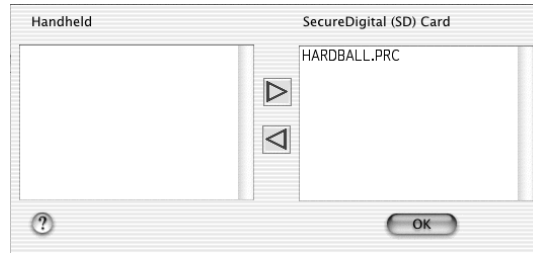





- Click OK to close the Change Destination window.
- Close the Install Handheld Files window.
- Perform a HotSync operation to install the selected application(s) on your handheld. See [“Performing cradle/cable HotSync operations”](#) in [Chapter 17](#) for details.

**NOTE** Files that remain in the list after you perform a HotSync operation were not installed. This can happen if the file type was not recognized during the HotSync operation. Expansion cards may hold applications that use files other than the Palm application files. For your handheld to recognize such a file, you must first launch the associated application at least once.

## Removing applications



If you run out of memory or decide that you no longer need an application you installed, you can remove applications from your handheld or from an expansion card. From your handheld, you can remove only add-on applications, patches, and extensions that you install; you cannot remove the applications that reside in the ROM portion of your handheld.

### To remove an add-on application:

- Press Home .
- Press Command Stroke  + D.  
Alternately, press Function  + Menu , and then select Delete on the App menu.
- Tap the Delete From pick list and select either Handheld or Card. If you want to delete applications from a card, the card must be seated in the expansion card slot.

4. Tap the application that you want to remove.



5. Tap Delete.
6. Press Function  + Enter , or tap Yes.
7. Press Function  + Enter , or tap Done.

## Removing Palm Desktop software

If you no longer want to use Palm Desktop software, you can remove it from your computer.

This process removes only the application files. The data in your Users folder remains untouched.

---

**IMPORTANT** If you remove Palm Desktop software, you also remove the HotSync Manager synchronization software and can no longer synchronize with your computer. If you want to synchronize data with another personal information manager (PIM), you need to install HotSync Manager from the Desktop Software CD-ROM after you remove Palm Desktop software. During the installation select the Custom option and then choose to install only HotSync Manager.

---

**NOTE** You may need to modify the steps shown here to accommodate the version of the operating system installed on your computer.

### To remove Palm Desktop software from a Windows computer:

1. From the Windows Start menu, select Settings and then click Control Panel.
2. Double-click the Add/Remove Programs icon.
3. Click the Change or Remove Programs button.
4. Select Palm Desktop.
5. Click Change/Remove.

This process removes only the application files. The data in your Users folder remains untouched.

6. Click Yes in the Confirm File Deletion box.
7. Click OK.
8. Click Close.

**To remove Palm Desktop software from a Mac computer:**

1. Insert the Desktop Software CD-ROM into the CD-ROM drive on your computer.
2. Double-click the Desktop Software CD-ROM icon on your desktop.
3. Double-click the Palm Desktop Installer icon.
4. From the Easy Install screen, select Uninstall from the pop-up menu.
5. Select the software you want to remove.
6. Click Uninstall.
7. Select the folder that contains your Palm Desktop software files.
8. Click Remove.
9. Restart your computer.



# Using Address Book



Address Book enables you to keep names, addresses, phone numbers, and other information about your personal or business contacts. Use Address Book to do the following:

- Quickly look up or enter names, addresses, phone numbers, and other information.
- Enter up to five phone numbers (home, work, fax, mobile, and so on) or e-mail addresses for each name.
- Define which phone number appears in the Address list for each Address Book entry.
- Attach a note to each Address Book entry, in which you can enter additional information about the entry.
- Assign Address Book entries to categories so that you can organize and view them in logical groups.
- Create your own digital business card that you can beam using e-mail to other devices with an infrared (IR) port.



**NOTE** You can encrypt your Address Book entries. For more information, see [“Encrypting your data”](#) in [Chapter 18](#).

**To open Address Book:**

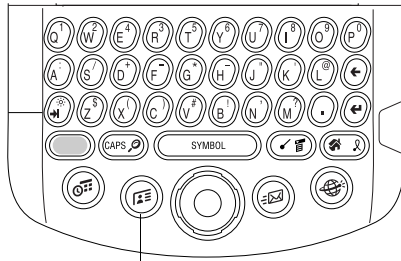
- Press the Address Book application button  on the front panel of your handheld. Address Book opens to display the list of all your records.



Address Book button

**TIP** Press the Address Book application button  repeatedly to cycle through the categories in which you have records. You can also press and hold the Address Book application button  to instantly beam your business card to another device with an IR port. The receiving device must also have an application that can read the Address Book data.

## Creating an Address Book entry

A record in Address Book is called an *entry*. You can create entries on your handheld, or you can use Palm™ Desktop software to create entries on your computer and then transfer the entries to your handheld during your next HotSync® operation.

Palm Desktop software also has data import capabilities so that you can load database files into Address Book on your handheld.

See “Importing data” in [Chapter 3](#) and Palm Desktop online Help for more information.

**To create a new Address Book entry:**

1. Press the Address Book button  on the front of your handheld to display the Address list.
2. Tap New.

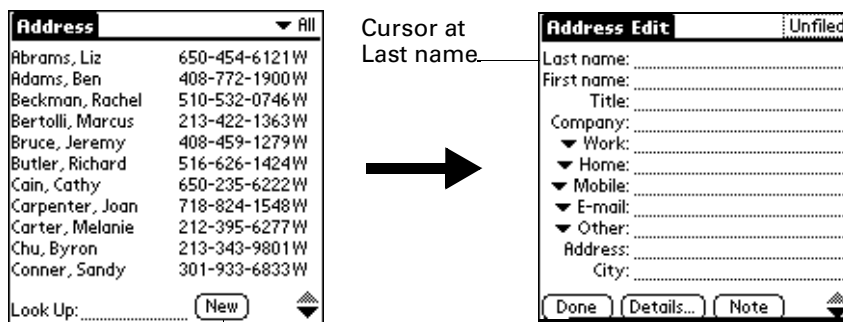

Tap New

3. Enter the last name of the person you want to add to your Address Book.

The handheld automatically capitalizes the first letter of each field (except numeric and e-mail fields). You do not have to use the CAPS key to capitalize the first letter of the name.



4. Tap the First Name field.

**TIP** Pressing Tab  moves the cursor to the next field.

5. Enter the first name of the person in the First Name field.

6. Enter the other information that you want to include in this entry.

As you enter letters in the Title, Company, City, and State fields, text appears for the first logical match that exists in your Address Book. As you enter more letters, a closer match appears. For example, you may already have Sacramento and San Francisco in your Address Book. As you enter *S*, Sacramento appears, and as you continue entering *a* and *n* San Francisco replaces Sacramento. As soon as the word you want appears, tap the next field to accept the word.

7. Tap the scroll arrows  or press Up/Down on the navigator to move to the next page of information.
8. After you finish entering information, Press Function  + Enter , or tap Done.



Tap Done

**TIP** To create an entry that always appears at the top of the Address list, begin the Last name or Company field with a symbol, as in \*If Found Call\*. This entry can contain contact information in case you lose your handheld.

## Selecting types of phone numbers

You can select the types of phone numbers or e-mail addresses that you associate with an Address Book entry. Any changes you make apply only to the current entry.

To select other types of phone numbers in an entry:

1. Tap the entry that you want to change.
2. Tap Edit.
3. Tap the pick list next to the label you want to change.

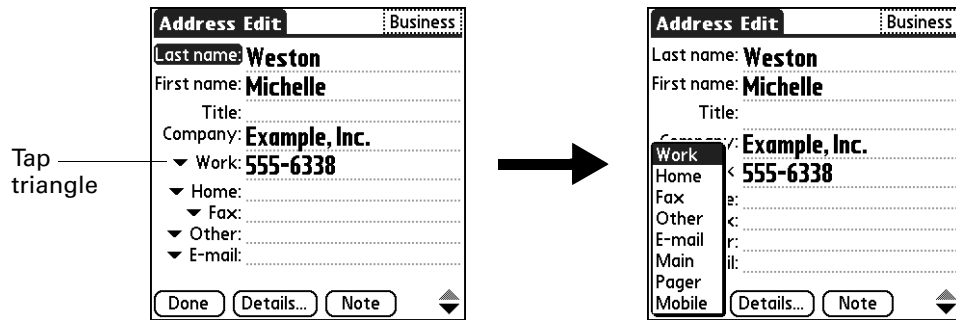

4. Select a new label.

## Changing Address Entry details

The Address Entry Details dialog box provides a variety of options that you can associate with an entry.

To open the Address Entry Details dialog box:

1. Tap the entry whose details you want to change.
2. Tap Edit.
3. Tap Details.



4. Select any of the following settings:

- |                     |  |
|---------------------|--|
| <b>Show in List</b> | Select which type of phone or other information appears in the Address list screen. Your options are Work, Home, Fax, Other, E-mail, Main, Pager, and Mobile. The identifying letters <i>W</i> , <i>H</i> , <i>F</i> , <i>O</i> , <i>M</i> , or <i>P</i> appear next to the record in the Address list, depending on which information is displayed. If you select E-mail, no identifying letter is displayed. |
| <b>Category</b>     | Assign the entry to a category.  |
| <b>Private</b>      | Hide this entry when Security is turned on.  |



## Making connections from Address Book

You can use the entries in your Address Book to launch applications that perform tasks such as dialing a phone number or creating an e-mail message. Some of the applications you can launch are included on the Software Essentials CD-ROM that comes with your handheld, and others may be available from third-party developers and are sold separately. Most of these applications require a GSM mobile phone or an optional modem accessory that is compatible with your handheld (mobile phone and modem accessory sold separately).

### Quick Connect

You can use Quick Connect to select an entry and initiate a related task with one hand, using the navigator. You can also configure which application opens when you choose a specific Address record field, and whether to add a prefix to all phone numbers.

To use Quick Connect from an Address entry:

1. Open the Address entry to which you want to connect.
2. Press Right on the navigator to open the Quick Connect dialog box.

**TIP** You can also tap the Quick Connect icon in the title bar of the Address record.

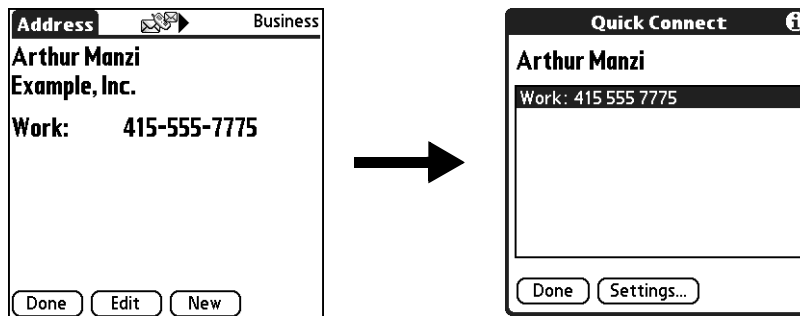

3. Select the method you want to use to connect.

Quick Connect initiates the related task. For example, if you tap a phone number, Quick Connect sends the selected phone number to your mobile phone.

**To use Quick Connect from the Address list:**

1. Highlight the Address entry to which you want to connect.
2. Press Command Stroke  + I.

Alternately, press Function  + Menu , and select Connect on the Record menu.

3. Select the method you want to use to connect.

Quick Connect initiates the related task. For example, if you tap a phone number, Quick Connect sends the selected phone number to your mobile phone.

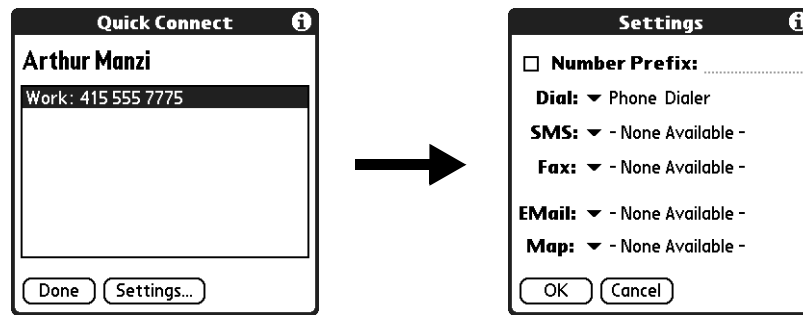

**To configure Quick Connect settings:**

1. From the Quick Connect dialog box, tap Settings.



2. (Optional) Tap the Number Prefix check box and enter a prefix.





For example, to dial 1 before all phone numbers, select this check box and enter a "1" in this field. The prefix is not added to a number that begins with the "+" character.

3. Tap each of the pick lists and select the application you want to associate with that task.
4. Press Function  + Enter , or tap OK.

**Tap-to-Connect**

With Tap-to-Connect you can select an entry and initiate a related task by tapping it with the stylus. By default, Tap-to-Connect is not enabled.

**To enable Tap-to-Connect:**

1. From the Address list, Press Command Stroke  + R.  
Alternately, press Function  + Menu , and select Preferences on the Options menu.
2. Tap Enable Tap-to-Connect.
3. Press Function  + Enter , or tap OK.

**TIP** You can also configure which application opens when you tap a specific Address record field, and whether to add a prefix to all phone numbers. See [“Quick Connect”](#) earlier in this chapter to learn how to configure these settings.

**To make a connection with Tap-to-Connect:**

1. Open the Address entry to which you want to connect.
2. Tap an item.  
For example, to dial a phone number, tap the number you want to dial. To address an e-mail message, tap an e-mail address.
3. (Optional) Tap the number to edit it.

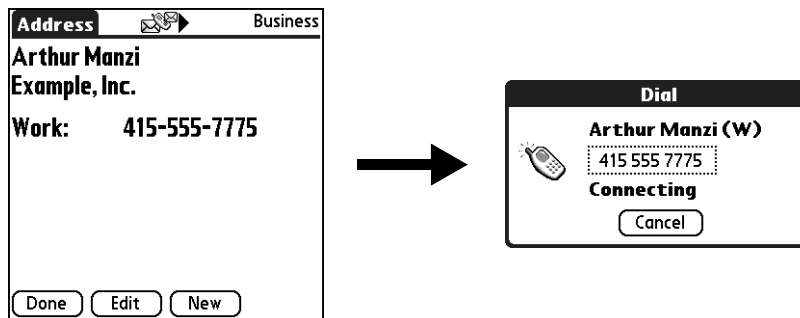

For example, you might want to add an area code, a “1,” or a country code before a phone number.

## Address Book menus

Address Book menus are shown here for your reference, and Address Book features that are not explained elsewhere in this book are described here.

See “Using menus” in [Chapter 4](#) for information about selecting menu commands.

The Record and Options menus may differ, depending on whether you’re displaying the Address list screen or the Address view screen.

### Record menus

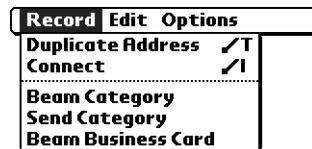

Address list

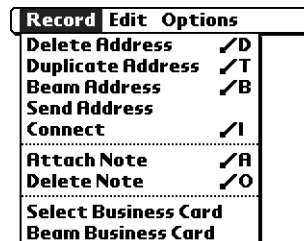

Address view

<b>Duplicate Address</b>	Makes a copy of the current record and displays the copy in Address Edit so you can make changes to the copied record. The copy has the same category and attached notes as the original record.
<b>Connect</b>	Opens the Quick Connect dialog box where you can select which application to use to make the connection.
<b>Send Category</b>	Opens a dialog box where you can select how to send all records in the selected category to another device. The options available depend on the software installed on your handheld.
<b>Send Address</b>	Opens a dialog box where you can select how to send the selected entry to another device. The options available depend on the software installed on your handheld.

## Options menus



Address list



Address view

### Preferences

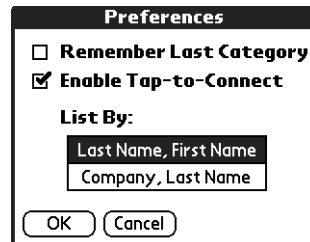

**Remember last category:** Determines how Address Book appears when you return to it from another application. If you select this check box, Address Book shows the last category you selected. If you clear it, Address Book displays the All category.

### Rename Custom Fields

Fields that appear at the end of the Address Edit screen. Rename them to identify the kind of information you enter in them. The names you give the custom fields appear in all entries.

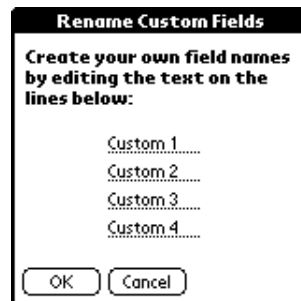

### About Address Book

Shows version information for Address Book.





# Using Calculator

 Calculator enables you to perform basic calculations. Use Calculator to do the following:

- Perform addition, subtraction, multiplication, division, and square root operations.
- Store and retrieve values.
- Display the last series of calculations, which is useful for confirming a series of “chain” calculations.

**To open Calculator:**

1. Press Home .
2. Tap the Calculator icon .

## Performing calculations

The Calculator includes several buttons to help you perform calculations.

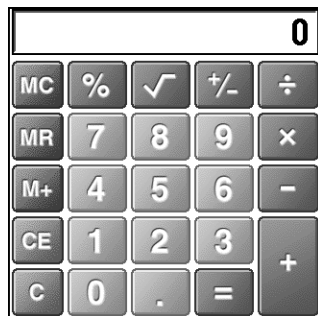

Clears the entire calculation, so that you can begin a fresh calculation.



Clears the last number you entered. If you make a mistake while entering a number in the middle of a calculation, you can use this button to reenter the number without starting the calculation over.



Toggles the current number between a negative and positive value. If you want to enter a negative number, enter the number first *and then press* the +/- button.



Places the current number in memory. Each new number you enter with the M+ button is *added to the total* already stored in memory. The number that you add can be either a calculated value or any number you enter by pressing the number buttons. Pressing this button has no effect on the current calculation (or series of calculations); it merely places the value into memory until it is recalled.



Recalls the stored value from memory and inserts it into the current calculation.



Clears any value that is stored in the Calculator memory.



Calculates the square root of a number. Enter the number, and then tap the square root button.

## Viewing recent calculations

The Recent Calculations command enables you to review the last series of calculations and is particularly useful for confirming a series of “chain” calculations.

To display recent calculations:

1. Press Command Stroke + 1.

Alternately, press Function + Menu , and then select Recent Calculations on the Options menu.

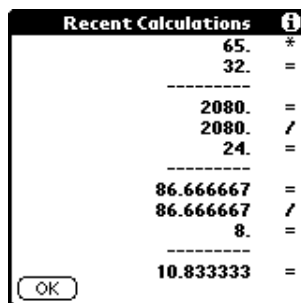

2. After you finish reviewing the calculations, press Function + Enter , or tap OK.



## Using Calculator menus

The Calculator menu shown here is for your reference, and the Calculator feature described here is not explained elsewhere in this book.

See “Using menus” in [Chapter 4](#) for information about choosing menu commands.

### Options menu

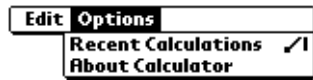

**About Calculator** Shows version information for Calculator.



# Using Card Info



 Card Info enables you to review general information about an expansion card. Use Card Info to do the following:

- Review card contents.
- Rename a card.
- Format a card.

## Reviewing Card Information

You can view the card name, type, available storage space, and a summary of its contents.

To review Card Information:

1. Press Home .
2. Tap the Card Info icon .
3. Review Card name, Type, and Size.
4. Review card contents summarized by directory.

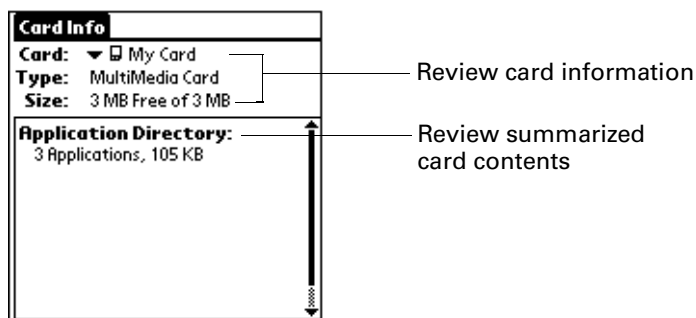

## Renaming a card

Renaming a card enables you to give an easy-to-recognize name to the card.

**To rename a card:**

1. Press Home (🏠).
2. Tap the Card Info icon (📄).
3. Press Command Stroke (⌘) + R.

Alternately, press Function (fn) + Menu (⌘), and then select Rename Card on the Card menu.

4. Enter the new name for the card.

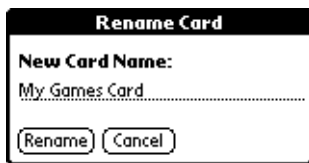

5. Tap Rename.

## Formatting a card

Formatting a card destroys all its data and prepares it to accept new applications and data.

**To format a card:**

1. Press Home (🏠).
2. Tap the Card Info icon (📄).
3. Press Command Stroke (⌘) + F.

Alternately, press Function (fn) + Menu (⌘), and then select Format Card on the Card menu.

4. Press Function (fn) + Enter (↵), or tap OK.

## Managing an expansion card

- When writing data to an expansion card, wait for your handheld to complete the operation before removing the card from the slot. This prevents data corruption or accidental damage to the expansion card.
- You can install applications to an expansion card after performing an initial HotSync® operation. See “Installing files and add-on applications” in [Chapter 4](#) for information. For optimal performance, we recommend that you do not install more than fifty applications to a single expansion card.
- When your handheld’s battery level becomes very low, access to the expansion card may be disabled to protect your data. If this occurs, recharge your handheld as soon as possible.

## Using the Card Info menu

The Card Info menu is shown here for your reference, and the Card Info features that are not explained elsewhere in this book are described here.

See “Using menus” in [Chapter 4](#) for information about choosing menu commands.

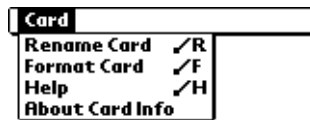

**Help** Provides help text.

**About Card Info** Shows version information for Card Info.



# Using Date Book



Date Book enables you to quickly and easily schedule appointments or any kind of activity associated with a time and date. Use Date Book to do the following:

- Enter a description of your appointment and assign it to a specific time and date.
- Display a chart of your appointments for an entire week. The Week view makes it easy to spot available times and potential scheduling overlaps or conflicts.
- Display a monthly calendar to quickly spot days where you have morning, lunch, or afternoon appointments.
- Display an agenda showing appointments, untimed events, and your To Do items for the day.
- Set an alarm to notify you of the scheduled activity.
- Create reminders for events that are based on a particular date, rather than time of day. Birthdays and anniversaries are easy to track with your handheld.
- Attach notes to individual events for a description or clarification of the entry in your Date Book.

**NOTE** You can encrypt your Date Book records. For more information, see [“Encrypting your data”](#) in [Chapter 18](#).

### To open Date Book:

- Press the Date Book application button  on the front panel of your handheld. Date Book opens to today’s schedule.

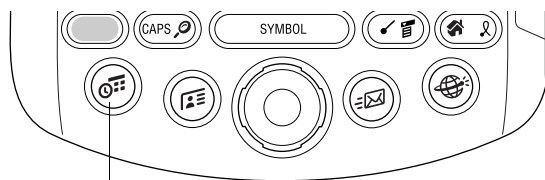

Date Book button

**TIP** Press the Date Book application button repeatedly to cycle through the Day, Week, Month, and Agenda views.

When you open Date Book, the screen shows the current date and a list of times for a normal business day.

## Scheduling an event

A record in Date Book is called an “event.” An event can be any kind of activity that you associate with a day. You can enter a new event on any of the available time lines.

When you schedule an event, its description appears on the time line, and its duration is automatically set to one hour. You can easily change the start time and duration for any event.

It’s possible to schedule events that overlap, but Date Book makes it easy to find such conflicts. See [“Spotting event conflicts”](#) later in this chapter.

You can also schedule events in your Date Book that occur on a particular date but have no specific start or end times, such as birthdays, holidays, and anniversaries. These are referred to as “untimed events.” Untimed events appear at the top of the list of times, marked with a diamond. You can have more than one untimed event on a particular date.

You can also schedule a repeating event, such as a weekly meeting, and continuous events, such as a three-day conference or a vacation.

**To schedule an event for the current day:**

1. Tap the time line that corresponds to the beginning of the event.

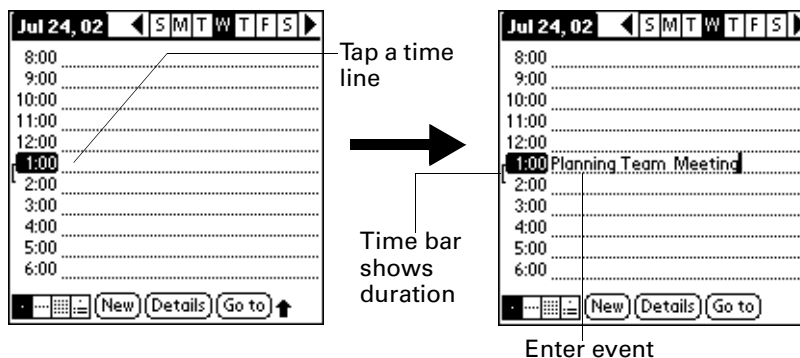

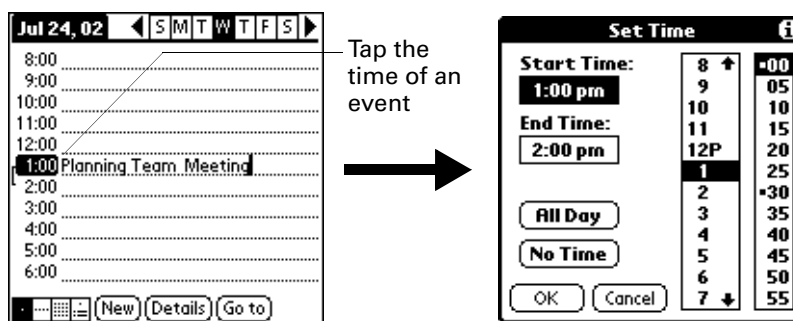

2. Enter a description of the event. You can enter up to 255 characters.
3. If the event is one hour long, skip to step 5. If the event is longer or shorter than an hour, tap the time of the event to open the Set Time dialog box.



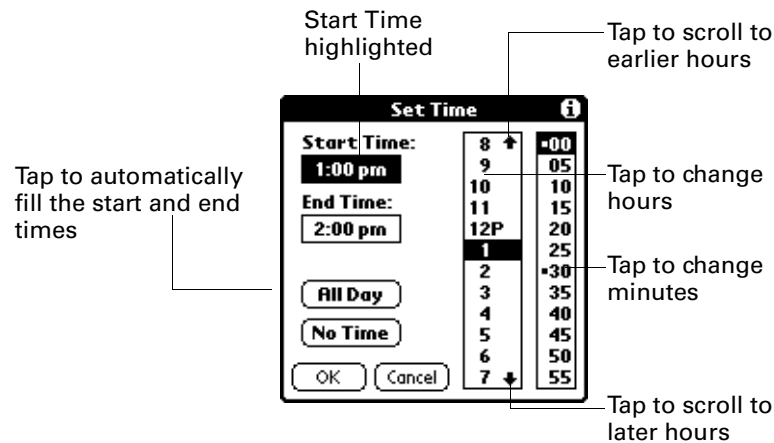

4. Do one of the following:
  - Tap the time columns on the right side of the Set Time dialog box to set the Start Time, and then tap the End Time box and tap the time columns to set the End Time.
  - Tap All Day to automatically insert the start and end time of the event as defined in your Date Book preferences.



5. Press Function  + Enter , or tap OK.
6. Tap a blank area of the screen to deselect the event. A vertical line appears next to the time, indicating the duration of the event.

If an event has the same start and end time, the time is displayed only once.

#### To schedule an event for another day:

1. Select the date you want for the event by doing one of the following:
  - Tap the day of the week that you want in the date bar at the top of the screen. If necessary, tap the Previous week or Next week scroll arrow to move to another week.

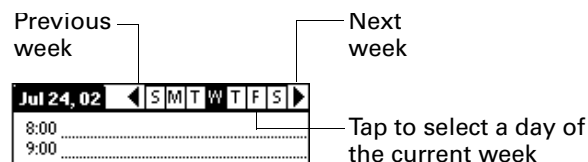

- Press Right or Left on the navigator to scroll to the next or previous day.
- Press Up or Down on the navigator to scroll within the current day.

- Tap Go To at the bottom of the screen to open the Go to Date dialog box. Select a date by tapping a year, month, and day in the calendar.

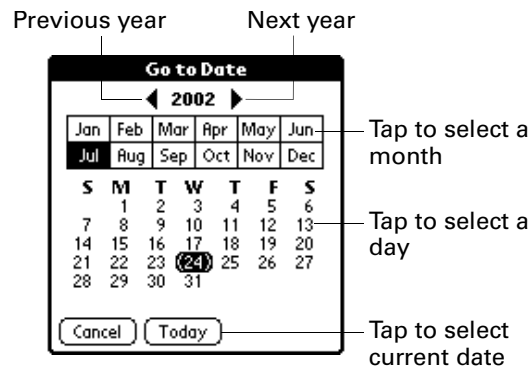

2. After you locate the date, follow the steps for scheduling an event for the current day.

**To schedule an untimed event:**

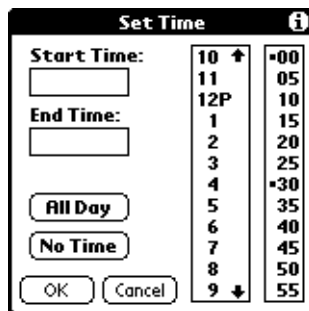

1. Select the date that you want for the event.
2. Tap New.
3. Tap No Time, so that no start or end time is defined for the new event.

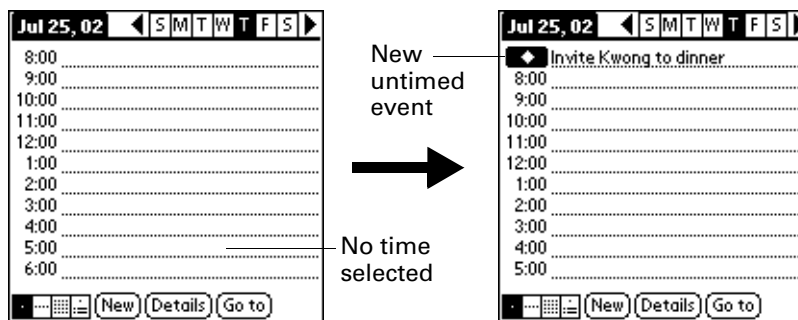

4. Enter a description of the event.



5. Tap a blank area on the screen to deselect the untimed event.

If you create an event and decide later that there is no particular start or end time, you can easily change it to an untimed event. Tap the time of the event in the Date Book screen, tap No Time, and then press Function  + Enter , or tap OK.

## Selecting an event

After you create an event, you can select an event to view its contents, reschedule it, make it a repeating event, and add alarms or notes.

### To select an event:



1. Go to the day on which the event is scheduled.
2. Tap the event.

**TIP** You can also press Select on the navigator to insert the highlight on the next event in the current day or on the first event of another day. To scroll through the events in the selected day, press Up and Down on the navigator.

## Rescheduling an event

You can easily make changes to your schedule with your handheld.

### To reschedule an event:

1. Select the event you want to reschedule.
2. Tap Details.
3. To change the time, tap the Time box and select a new time.
4. To change the date, tap the Date box and select a new date.
5. Press Function  + Enter , or tap OK.

## Setting an alarm for an event

The Alarm setting enables you to set an alarm for events in your Date Book. You can set an alarm to notify you minutes, hours, or days before an event. The default Alarm setting is five minutes before the time of the event, but you can change the Alarm to any number of minutes, hours, or days.





When you set an alarm, this icon  appears at the far right of the event with the alarm. When the alarm occurs, a reminder message also appears onscreen.

### To set an alarm for an event:

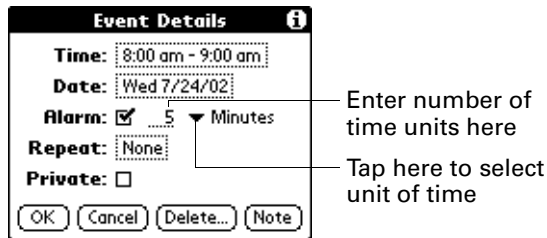
1. Select the event to which you want to assign an alarm.
2. Tap Details.

3. Tap the Alarm check box to select it.  
The default setting, 5 Minutes, appears.
4. Tap the pick list to select Minutes, Hours, or Days.
5. Select the 5 and enter any number from 0 to 99 (inclusive) as the number of time units.



6. Press Function  + Enter , or tap OK.
7. When the reminder message appears on screen, do one of the following:
  - Press Function  + Enter , or tap OK, to permanently dismiss the reminder and return to the current screen.
  - Tap Snooze to dismiss the reminder and return to the current screen. The reminder message appears again five minutes after you tap Snooze, and meanwhile an attention indicator blinks in the upper-left corner of the screen to remind you of the pending alarm.
  - Tap Go To to open Date Book. Date Book opens and displays the event associated with the alarm.

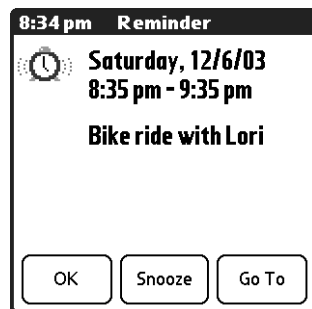

**Alarm for untimed events:** You can set a silent alarm for an untimed event. In this case, the alarm triggers at the specified period of minutes, hours, or days before midnight (beginning) of the day of the untimed event. When the alarm triggers, the reminder list displays the alarm message until you clear it. See [“Receiving alerts”](#) in [Chapter 4](#) for details.

For example, you might set an alarm for an untimed event that occurs on February 4. If the alarm is set for five minutes, the reminder message appears at 11:55 PM on the night of February 3. The reminder remains in the reminder list until you turn on your handheld and dismiss it.

## Scheduling repeating or continuous events

The Repeat function lets you schedule events that recur at regular intervals or extend over a period of consecutive days.



A birthday is a good example of an event that repeats annually. Another example is a weekly guitar lesson that falls on the same day of the week and the same time of day.

A business trip or a vacation is an example of a continuous event.

To schedule a repeating or continuous event:

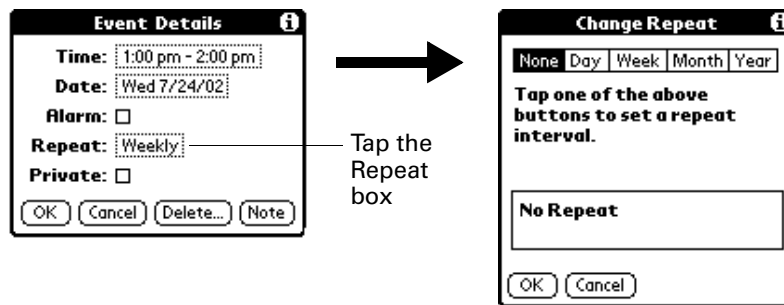
1. Select the event.
2. Tap Details.
3. Tap the Repeat box to open the Change Repeat dialog box.





4. Tap Day, Week, Month, or Year to set how often the event repeats.  
For a continuous event, tap Day.
5. On the Every line, enter a number that corresponds to how often you want the event to repeat.  
For example, if you select Month and enter the number 2, the event repeats every other month.
6. To specify an end date for the repeating or continuous event, tap the End on pick list and tap Choose Date. Use the date picker to select an end date.
7. Press Function  + Enter , or tap OK.

After you schedule a repeating or continuous event, the Repeat icon  appears at the far right of the event.



## Changing repeating or continuous events

When you make changes to a repeating or continuous event, such as deleting or adding notes or changing the time of an event, you can decide which of the events you want to change—all events in the series, just the current event, or the current and future events.

**To delete repeating events:**

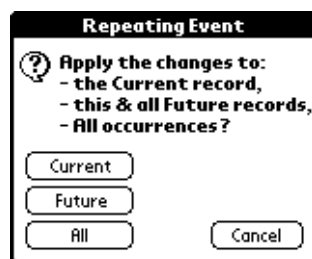
1. Select the record you want to delete.
2. Press Function  + Menu .
3. Select Record, and then select Delete Event.
4. Do one of the following:
  - Tap Current to delete only the current event item.
  - Tap Future to delete the current and all future event items and reset the end date of the repeating event to the last shown date.
  - Tap All to delete all occurrences of the repeating event.



5. Press Function  + Enter , or tap OK.

## Considerations for repeating or continuous events

Keep the following points in mind:

- If you change the start date of a repeating event, your handheld calculates the number of days you moved the event. Your handheld then automatically changes the end date to maintain the duration of the repeating event.
- If you change the repeat interval (e.g., daily to weekly) of a repeating event, past occurrences (prior to the day on which you change the setting) are not changed, and your handheld creates a new repeating event.
- If you change the date of an occurrence of a repeating event (e.g., from January 14th to January 15th) and apply the change to all occurrences, the new date becomes the start date of the repeating event. Your handheld adjusts the end date to maintain the duration of the event. If you apply the change to current and future occurrences, past occurrences are not changed.
- If you change other repeat settings (e.g., time, alarm, private) of a repeating event and apply the change to all occurrences, your handheld creates a new event. The start date of this new event is the day on which the setting is changed.
- If you apply a change to a single occurrence of a repeating event (e.g., time), that occurrence no longer shows the Repeat icon .

## Changing the Date Book view

In addition to displaying the time list for a specific day, you can also display a whole week, a month, an agenda, and the current time.

To cycle through Day, Week, Month, and Agenda views:

- Press the Date Book application button repeatedly to display the next view.
- Tap the appropriate view icon in the lower-left corner of Date Book.

### Working in Week view

Week view shows the calendar of your events for an entire week. This view lets you quickly review your appointments and available time slots. In addition, the graphical display helps you spot overlaps and conflicts in your schedule.

To display the Week view:

1. Tap the Week view icon.

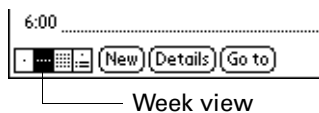

2. Tap the navigation controls to move forward or backward a week at a time, or tap on a column to display details of an event.

The Week view also shows untimed events and events that are before and after the range of times shown. Untimed repeating events appear in green.

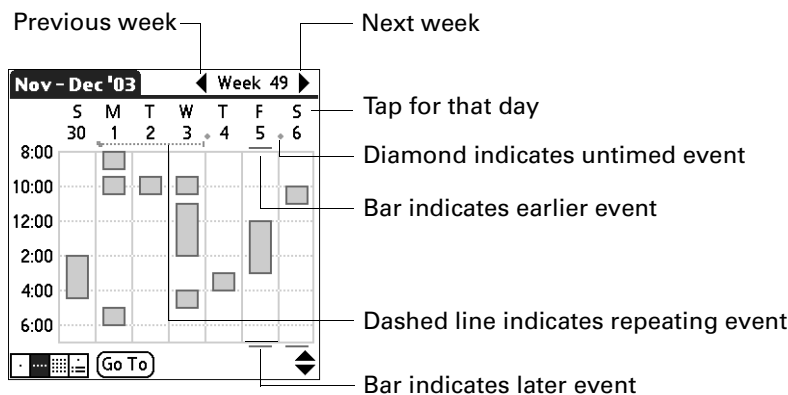

3. Tap an event to show a description of the event.

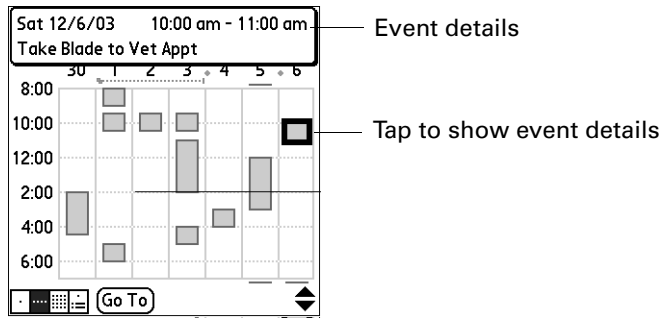

### Tips for using Week view

Keep the following points in mind:

- To reschedule an event, tap and drag the event to a different time or day.
- Tap a blank time on any day to move to that day and have the time selected for a new event.
- Tap any day or date that appears at the top of the Week view to move directly to that day without selecting an event.
- Press Right and Left on the navigator to scroll to the next or previous week.
- Press Select on the navigator to insert the highlight, and then press Right and Left to select a day within the selected week. To view the events on the selected day, press Select on the navigator again.
- The Week view shows the time span defined by the Start Time and End Time in the Date Book Preferences settings. If you have an event before or after this time span, a bar appears at the top or bottom of that day's column. Use the onscreen scroll arrows to scroll to the event, or press Up and Down on the navigator to scroll to earlier and later time slots within the selected week.

### Working in Month view

The Month view screen shows which days have events scheduled. Dots and lines in the Month view indicate events, repeating events, and untimed events.

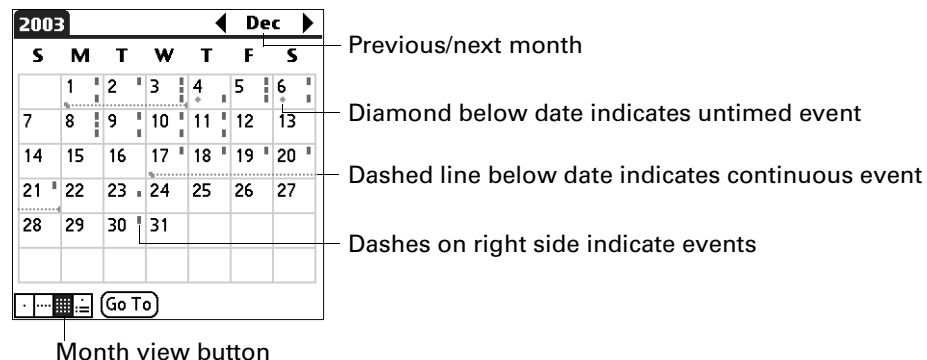



You can control the dots and lines that appear in the Month view. See “[Display Options](#)” later in this chapter.

### Tips for using Month view

Keep the following points in mind:

- Tap a day in the Month view to display that day in the Day view.
- Tap the scroll arrows in the upper-right corner, or press Left and Right on the navigator, to move forward or backward a month.
- Press Select on the navigator to insert the highlight, and then press Left and Right on the navigator to scroll to a specific day. Press Select on the navigator to display that day in the Day view.
- Untimed repeating events appear in green.

## Working in Agenda view

The Agenda view shows you your untimed events, appointments, and To Do items in one screen. When you tap an untimed event or appointment in the Agenda view, the Day view appears so you can see more detailed information about the event. You can tap the check box next to a To Do item to mark it as completed. When you tap a To Do item, your To Do list appears.

**NOTE** Which To Do items appear and how you can change them depend on the settings in your To Do preferences. See “[Setting To Do preferences](#)” in [Chapter 13](#) for more information.

To display the Agenda view:

1. Tap the Agenda view icon.



- Tap the navigation controls to move forward or backward a day at a time, or to display more events and To Do items.

**TIP** You can also press Up and Down on the navigator to scroll through the events on the selected day, or press Right and Left on the navigator to scroll to the next or previous day.

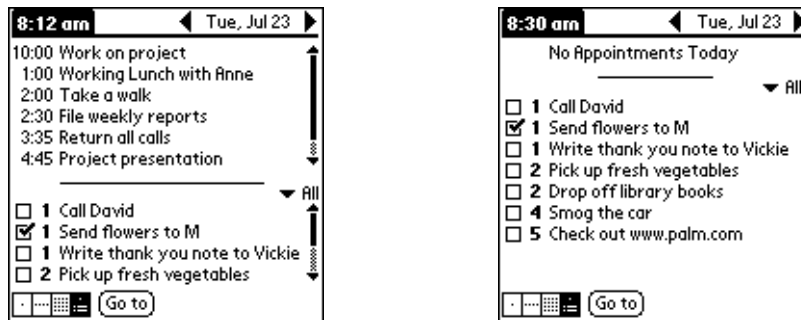

**NOTE** You can also change the category of To Do items shown. Tap the pick list to choose another category. See [Chapter 13](#) for more information on working with To Do items.

## Spotting event conflicts

With the ability to define specific start and end times for any event, it's possible to schedule events that overlap (an event that starts before a previous event finishes).

An event conflict (time overlap) appears in the Week view as overlapping bars. The first event created appears as a gray bar, and any subsequent conflicting events appear as a single red bar. The Day view displays overlapping red brackets to the left of the conflicting times. The Month view displays conflicting appointments in red.

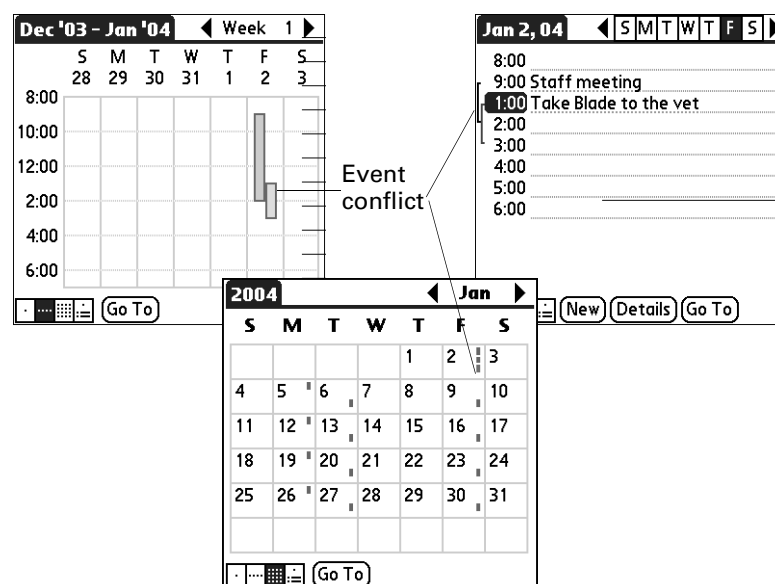

## Using Date Book menus

Date Book menus are shown here for your reference, and Date Book features that are not explained elsewhere in this book are described here.

See “Using menus” in [Chapter 4](#) for information about choosing menu commands.

### Record menu



#### Send Event

Opens a dialog box where you can choose how you want to send the selected event to another device. The options available depend on the software installed on your handheld.

### Options menu



## Display Options

Allows you to change Date Book's appearance and which events are displayed.



- |                            |  |
|----------------------------|--|
| <b>Show Time Bars</b>      | Activates the time bars that appear in the Day view. The time bars show the duration of an event and illustrate event conflicts.   |
| <b>Compress Day View</b>   | Controls how times appear in the Day view. When Compress Day View is off, all time slots are displayed. When it is on, start and end times are displayed for each event, but blank time slots toward the bottom of the screen disappear to minimize scrolling. |
| <b>Month View settings</b> | These check boxes apply to the Month view of the Date Book. You can deactivate any or all of these settings to hide Timed, Untimed, or Daily Repeating events in the Month view <i>only</i> .  |

## Preferences



- Start/End Time** Defines the start and end times for Date Book screens. If the time slots you select do not fit on one screen, you can tap the scroll arrows  to scroll up and down.
- Alarm Preset** Automatically sets an alarm for each new event. The silent alarm for untimed events is defined by minutes, days, or hours before midnight at the end of the date of the event.
- Alarm Sound** Sets the tone of the alarm.
- Remind Me** Defines how many times the alarm occurs after the initial occurrence. The choices are Once, Twice, 3 Times, 5 Times, and 10 Times.
- Play Every** Defines how often the alarm sounds. The choices are Minute, 5 minutes, 10 minutes, and 30 minutes.

## About Date Book

Shows version information for Date Book.



# Using Expense



Expense enables you to keep track of your expenses and then transfer the information to a spreadsheet on your computer. In Expense you can do the following:

- Record dates, types of expenses, amount spent, payment method, and other details associated with any money that you spend.
- Assign expense items to categories so that you can organize and view them in logical groups.
- Keep track of vendors (companies) and people involved with each expense.
- Log miles traveled for a particular date or expense category.
- Sort your expenses by date or expense type.
- Send or export your expense information to popular computer applications, such as Microsoft Excel or Microsoft Word, using Palm™ Desktop software and HotSync® technology on a Windows computer.

---

**IMPORTANT** To access Expense, you must first perform a HotSync operation with your handheld. Expense is automatically loaded onto your handheld during the first HotSync operation.

---

To open Expense:

1. Press Home .
2. Select the Expense icon .

Expense		▼ All
4/4	Breakfast	\$ 23.00
4/4	Dinner	\$ 65.00
4/4	Hotel	\$ 88.33
4/4	Mileage	mi 366
4/4	Taxi	\$ 23.00
4/5	Business Meals	\$ 269.00

New Details... Show...

## Adding expense items

A record in Expense is called an *item*. You can sort your Expense items into categories or add other information that you want to associate with the item.

1. Tap New.

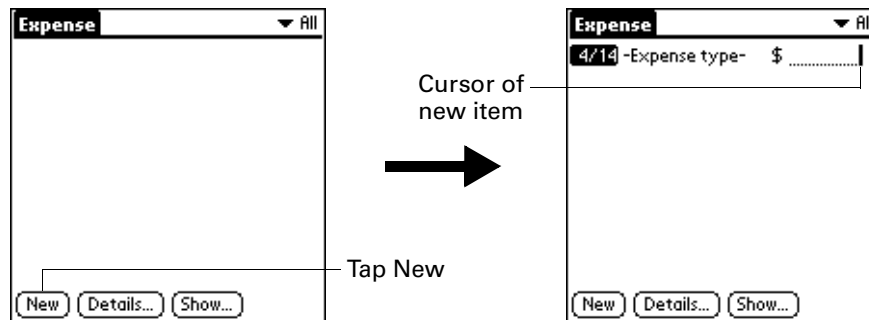

2. Enter the amount of the expense.
3. Tap the Expense type pick list and select a type from the list.

As soon as you select an expense type, your handheld saves your entry. If you do not select an expense type, it does not save the entry.

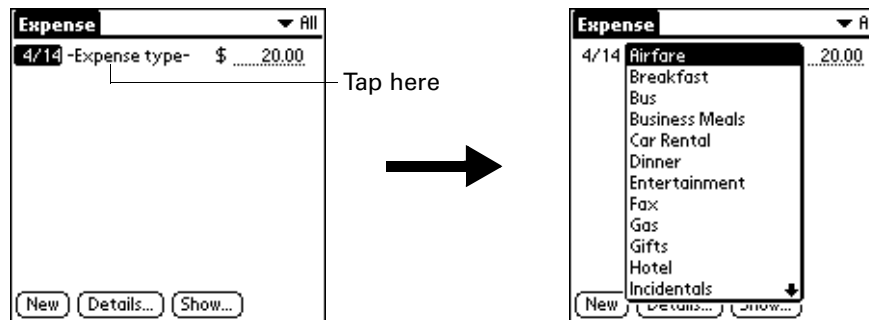

**TIP** Another quick way to create a new Expense item is to make sure that no Expense item is selected in the Expense list, type the first letter(s) of the expense type, and then type the numerical amount of the Expense item. This technique takes advantage of the automatic fill feature. See “[Options menu](#)” later in this chapter for details.



## Changing the date of an Expense item

Initially, Expense items appear with the date on which you enter them. You can change the date associated with any Expense item.

To change the date of an Expense item:

1. Tap the Expense item you want to change.
2. Tap the date of the selected item.

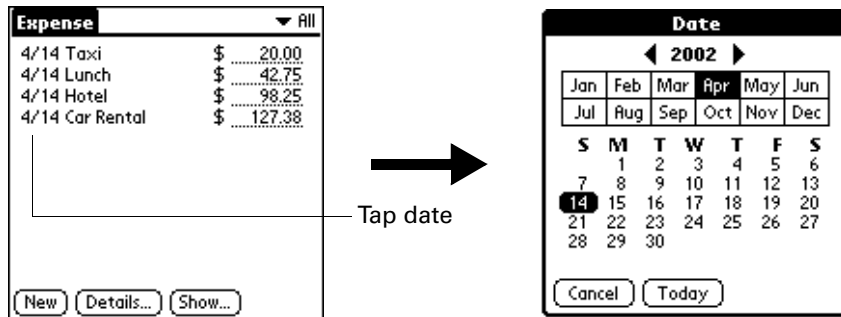

3. Tap the new date.

## Entering receipt details

Expense provides a variety of options that you can associate with an item. These options appear in the Receipt Details dialog box.

To open the Receipt Details dialog box:

1. Tap the Expense item to which you want to assign details.
2. Tap Details.

The 'Receipt Details' dialog box contains the following fields and options:

- Category:** ▼ Unfiled
- Type:** ▼ Lunch
- Payment:** ▼ Unfiled
- Currency:** ▼ \$
- Vendor:** .....
- City:** .....
- Attendees:** Who...



Buttons at the bottom: OK, Cancel, Delete, Note, ↑

3. Select any of the following options:

**Category** Opens a pick list of system and user-defined categories. See [“Categorizing records”](#) in [Chapter 4](#) for more information.

**Type** Opens a pick list of expense types.

- Payment** Enables you to choose the payment method used to pay the Expense item. If the item is prepaid (such as airline tickets supplied by your company), you can choose Prepaid to place your expense in the appropriate company-paid cell of your printed expense report.
- Currency** Enables you to choose the type of currency used to pay the Expense item. The default currency unit is defined in the Preferences dialog box. You can also display up to four other common types of currency. See the next section, [“Customizing the Currency pick list”](#) for more information.
- Vendor and City** Enables you to record the name of the vendor (usually a company) associated with the expense and the city where the expense was incurred. For example, a business lunch might be at Rosie’s Cafe (Vendor) in San Francisco (City).
- Attendees** See [“Looking up names to add to Expense records”](#) in Chapter 4 for more information.

4. Press Function  + Enter , or tap OK.





## Customizing the Currency pick list

You can select the currencies and symbols that appear in the Currency pick list.

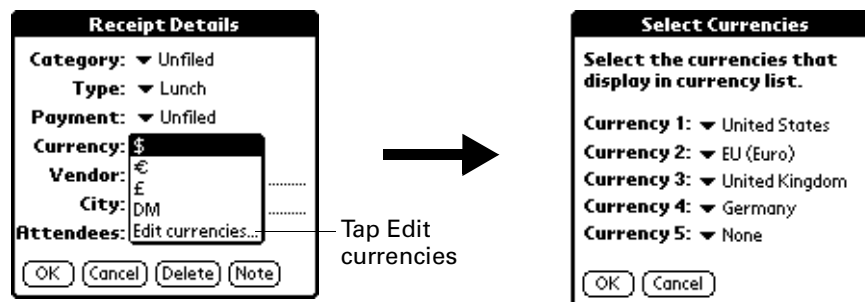
To customize the Currency pick list:

1. Tap the Currency pick list in the Receipt Details dialog box, and then select Edit currencies.





2. Tap each Currency pick list and select the country whose currency you want to display on that line.
3. Press Function  + Enter , or tap OK, to close the Select Currencies dialog box.
4. Press Function  + Enter , or tap OK.



## Changing the default currency

You can select which currency appears by default when you're entering Expense items. You can override this setting when entering individual expense items.

To change your default currency:

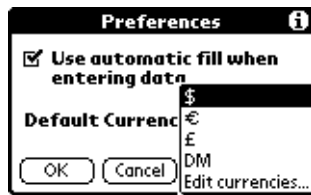
1. Open Expense.
2. Press Command Stroke  + R.  
Alternately, press Function  + Menu , and then select Preferences on the Options menu.
3. Tap the Default Currency pick list.
4. Select the currency symbol that you want to appear in Expense.





5. Press Function  + Enter , or tap OK.

## Defining a custom currency symbol

If the currency you want to use is not in the list of countries, you can create your own custom country and currency symbol.



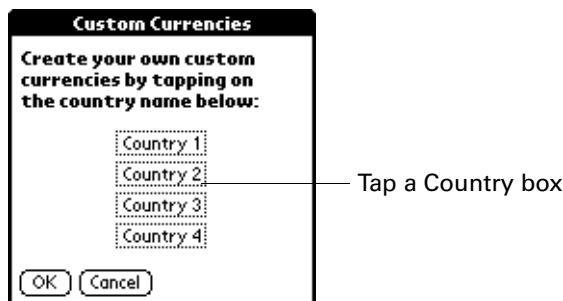

To define a custom currency symbol:

1. Press Command Stroke  + Y.  
Alternately, press Function  + Menu , and then select Custom Currencies on the Options menu.
2. Tap one of the four Country boxes.



3. Enter the name of the country and the symbol that you want to appear in Expense.



4. Press Function  + Enter , or tap OK, to close the Currency Properties dialog box.
5. Press Function  + Enter , or tap OK.

**NOTE** If you want to use your custom currency symbol as the default for all Expense items, select the symbol in the Preferences dialog box. If you want to use your custom currency symbol only for a particular Expense item, select the symbol in the Receipt Details dialog box associated with that item.

## Setting Show Options

Show Options defines the sort order and other settings that relate to your Expense items.

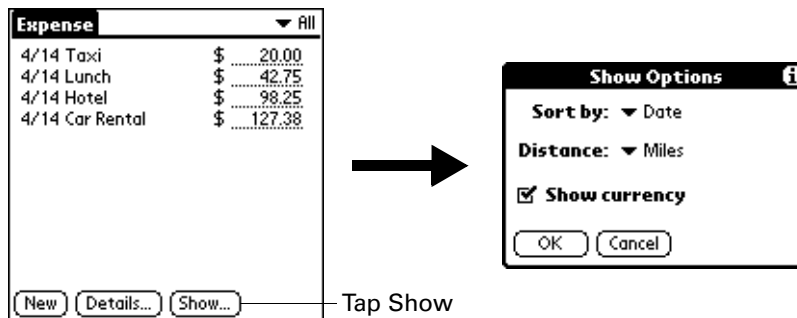

To open the Show Options dialog box:

1. In the Expense list, tap Show.
2. Select any of the options.



Tap Show

- Sort by** Enables you to sort expense items by date or type.
- Distance** Enables you to display Mileage entries in miles or kilometers.
- Show currency** Shows or hides the currency symbol in the Expense list.

3. Press Function  + Enter , or tap OK.

## Working with Expense data on your computer

After you enter your expenses into the Expense application on your handheld and perform a HotSync operation, Palm Desktop software enables you to do any of the following on your computer. See the Palm Desktop software online Help for details. This feature is not available on Mac computers.

- Add, modify, and delete your Expense data.
- Organize your Expense data by category, amount, date, type, or notes.
- View Expense data in various formats: List, Large Icons, or Small Icons.
- Record individual expenses in various currencies and display the total in one selected currency type.
- Print Expense reports.
- Transfer Expense data to other applications, such as Microsoft Excel, using the Send command or Export command, and import data in popular file formats.

### Displaying the euro on your computer

When you perform a HotSync operation, the euro symbol is transferred to Palm Desktop software like any other piece of data on your handheld. The symbol appears in Palm Desktop software, however, only if you are using fonts that support the euro symbol.

These fonts are part of the operating system on your computer. They do not reside with your Desktop application, and they are not produced by Palm, Inc. For more information, refer to the documentation that accompanies your desktop computer's operating system.

### Printing the euro

Even with operating system support, problems may arise when you print documents that contain the euro. When a font is present on both the printer and the computer, the printer font is used by default to increase printing speed. If the printer font does not include the euro, a box is printed instead of the euro symbol.

These fonts are part of the operating system on your computer. They do not reside with your Desktop application, and they are not produced by Palm, Inc. For more information, refer to the documentation that accompanies your desktop computer's operating system.

## Using Expense menus

Expense menus are shown here for your reference, and Expense features that are not explained elsewhere in this book are described here.

See "Using menus" in [Chapter 4](#) for information about choosing menu commands.

## Record menu

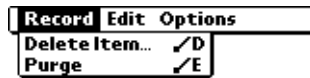

## Options menu



**Preferences** Opens the Preferences dialog box, where you can select automatic fill and default currency options.

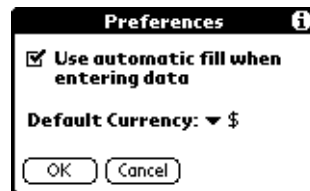

**Use automatic fill.** Enables you to select an expense type by typing the first letter of an expense type. For example, if you type the letter *T*, it enters the “Taxi” expense type. Typing *T* and then *E* enters *Telephone*, which is the first expense type beginning with the letters *TE*.

**About Expense** Shows version information for Expense.

# Using Memo Pad



Memo Pad provides a place to take notes that are not associated with records in Date Book, Address Book, or To Do List. The number of memos you can store is dependent only on the memory available on your handheld. Use Memo Pad to do the following:

- Send memos to popular computer applications like Microsoft Word when you synchronize using Palm™ Desktop software and HotSync® technology.
- Assign memos to categories so that you can organize and view them in logical groups.
- Write down phone numbers and other types of information that you can later copy and paste into other applications.

**NOTE** You can encrypt your Memo Pad memos. For more information, see “[Encrypting your data](#)” in [Chapter 18](#).

**To open Memo Pad:**

1. Press Home .
2. Tap the Memo Pad icon .

## Creating memos



A record in Memo Pad is called a *memo*. You can assign memos to categories and mark them private as described in [Chapter 4](#). This section covers how to create a memo.

To create a new memo:

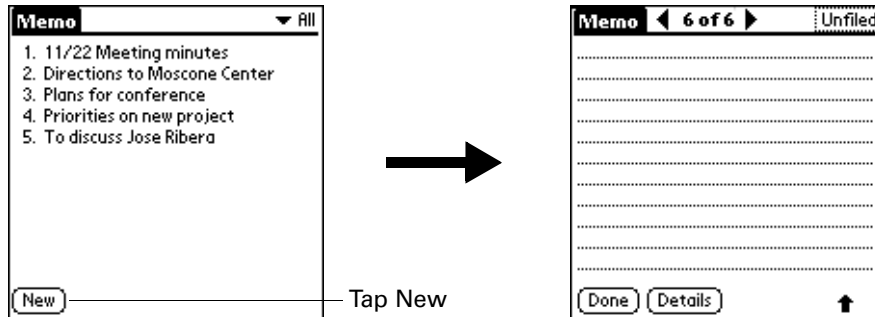
1. Open Memo Pad.
2. Tap New.



**TIP** In the Memo list screen, you can also begin typing to create a new memo. The first letter is automatically capitalized and begins your new memo. If you have a memo open, you can press Command Stroke  + N.

3. Enter the text that you want to appear in the memo.
4. Press Function  + Enter , or tap Done.

## Reviewing memos



The first line of a memo appears in the Memo list. This makes it easy to locate and review your memos.

To review a memo:

1. In the Memo list, select the text of the memo.

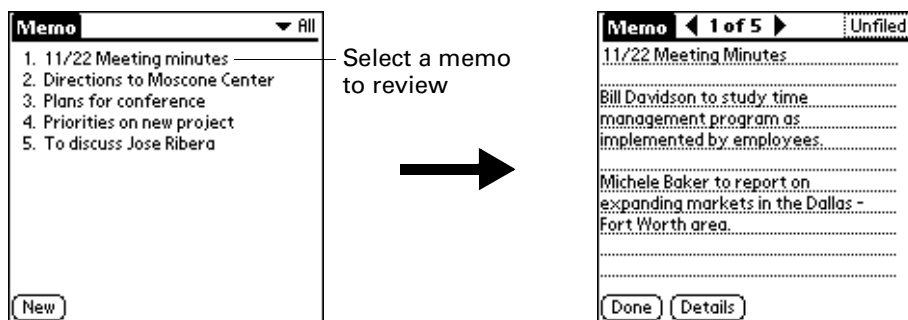
**TIP** You can also select, review, and move between memos with the navigator. See [“Using the navigator”](#) in [Chapter 3](#) for details.



2. Review or edit the text in the memo.
3. Press Function  + Enter , or tap Done.



## Using Memo Pad menus

Memo Pad menus are shown here for your reference, and Memo Pad features that are not explained elsewhere in this book are described here.

See “Using menus” in [Chapter 4](#) for information about choosing menu commands.

The Record and Options menus differ, depending on whether you’re displaying the Memo list or an individual memo.

### Record menus

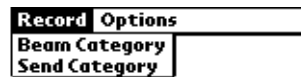

Memo list

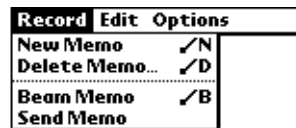

Memo screen

**Send Category** Opens a dialog box where you can choose how to send all records in the selected category to another device. The options available depend on the software installed on your handheld.

**Send Memo** Opens a dialog box where you can choose how to send the selected memo to another device. The options available depend on the software installed on your handheld.

### Options menus



Memo list



Memo screen

**Preferences** Displays the Memo Preferences dialog box, where you define the sort order for memos.

**About Memo Pad** Shows version information for Memo Pad.



# Using Note Pad



Note Pad provides a place to take notes in your own handwriting. You can use Note Pad to do everything you might do with a piece of paper and a pencil. Use Note Pad to do the following:

- Take notes, draw a sketch, or write any kind of message directly on your handheld screen. Later, you can enter this information into other applications.
- Set an alarm to use your notes as reminder messages.
- Assign notes to categories so that you can organize and view them in logical groups.
- Exchange notes with other devices that have Note Pad 2.x installed.
- Use Palm™ Desktop software and HotSync® technology to copy and paste notes into popular computer applications like Microsoft Word, or to send notes as e-mail attachments.

**NOTE** You can encrypt your Note pad notes. For more information, see [“Encrypting your data”](#) in [Chapter 18](#).

### To open Note Pad:

1. Press Home .
2. Select the Note Pad icon .

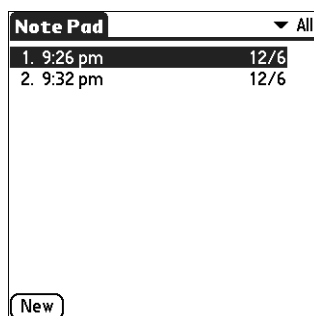

## Creating a note

A record in Note Pad is called a *note*. You can assign notes to categories and mark them private as described in [Chapter 4](#). This section covers how to create a note.

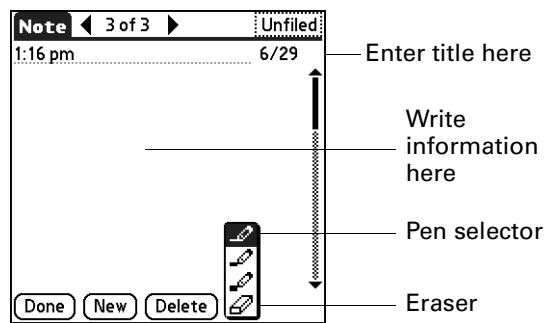

To create a new note:

1. Tap New.





1. Write the information directly on the handheld screen.

Tap the pen selector to select a different pen width, or select the eraser to remove unwanted strokes.

2. Press Function  + Enter , or tap Done.

To clear the screen:

1. Press Function  + Menu .
2. Select Edit, and then select Clear Note.

## Reviewing notes



The note title and the date you created the note appear in the Note Pad list. If you did not assign a title to your note, the time you created the note appears as the note title. This makes it easy to locate and review your notes.

To review a note:

1. In the Note Pad list, select the note title.

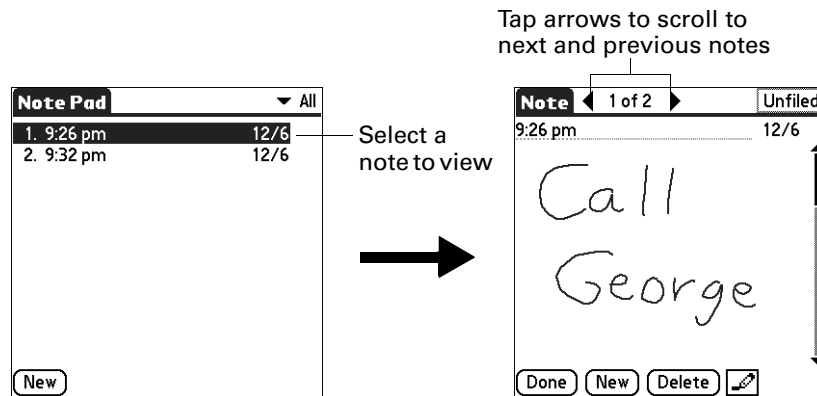
**TIP** You can also select, review, and move between notes with the navigator. See [“Using the navigator”](#) in [Chapter 3](#) for details.





2. Review or edit the contents of the note.
3. Press Function  + Enter , or tap Done.

## Changing Note Pad color settings

By default, your notes appear with a white “paper” background, and the ink from the pen is blue. You can change the color of both the paper and the ink from the pen. Your color selections apply to all your notes. You cannot change the color settings for individual notes.



To set the colors:

1. In the Note Pad list, press Command Stroke  + R.

Alternately, press Function  + Menu , and then select Preferences on the Options menu.

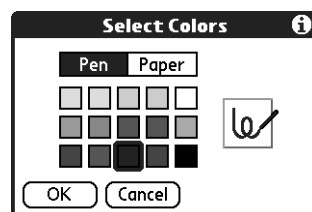
2. Tap Color.



3. Tap Pen, and then tap the color of ink you want to use.
4. Tap Paper, and then tap the color of paper you want to use.
5. Press Function  + Enter , or tap OK.

## Setting an alarm for a note

You can set an alarm for a specific time and date to remind you to follow up on a note.

To set an alarm for a note:

1. Tap the note to which you want to assign an alarm.
2. Press Command Stroke  + A.

Alternately, press Function  + Menu , and then select Alarm on the Options menu.

3. Tap the Date box.

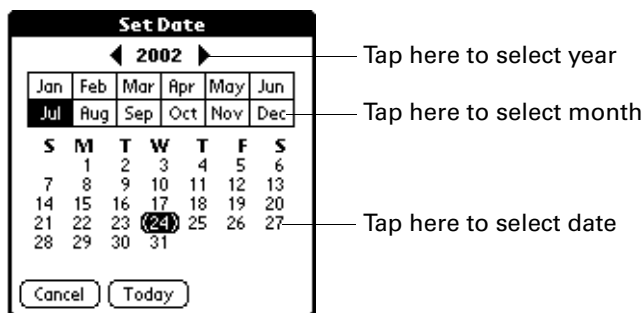



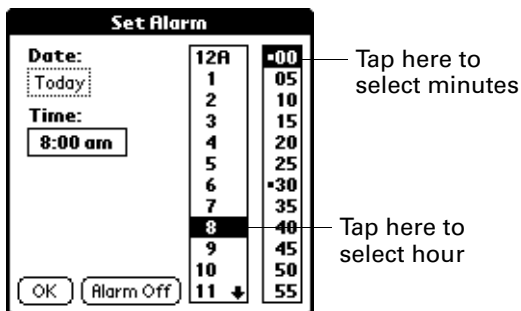

4. Tap the year, month, and date you want the alarm to sound.

After you tap the date, the Set Alarm dialog box reappears.

5. Tap the Time box.
6. Tap the hour and minute columns to select the time you want the alarm to occur.



7. Press Function  + Enter , or tap OK.

8. When the alarm goes off and the reminder message appears on screen, do one of the following:
- Press Function  + Enter , or tap OK, to permanently dismiss the reminder and return to the current screen.
  - Tap Snooze to dismiss the reminder and return to the current screen. An attention indicator blinks in the upper-left corner of the screen to remind you of the pending alarm, and the reminder message appears again in five minutes. When the reminder message reappears, the current time appears in the Reminder bar and the note title appears on the screen.
  - If you did not title the note, the time the note was created appears on the screen.
  - Tap Go To to open Note Pad. Note Pad will open and display the note associated with the alarm.

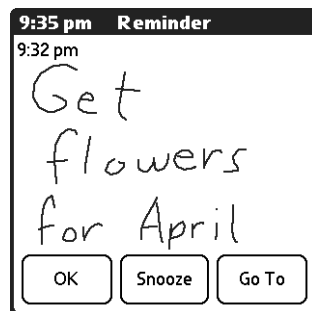

## Using Note Pad menus

Note Pad menus are shown here for your reference, and Note Pad features that are not explained elsewhere in this book are described here.

The Record menu is the same when you're viewing the Note Pad list and an individual note. The Options menu differs, depending on whether you're viewing the Note Pad list or an individual note.

### Record menu

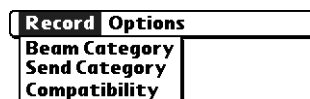

Note Pad list

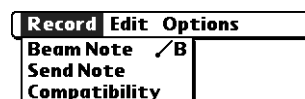

Note screen

- Send Category** Opens a dialog box where you can choose how you want to send all records in the selected category to another device. The options available depend on the software installed on your handheld.

- Send Note** Opens a dialog box where you can choose how you want to send the selected note to another device. The options available depend on the software installed on your handheld.
- Compatibility** Displays the Compatibility dialog box, where you can choose to beam notes to a previous version of Note Pad.

## Options menus



Note Pad list



Note screen

- Preferences** Displays the Note Pad Preferences dialog box, where you define the pen and paper color, the sort order for notes, and the alarm sound.
- Details** Displays the Note Details dialog box, where you assign a category and privacy option for a note.
- About Note Pad** Shows version information for Note Pad.



# Using Palm™ Photos



Palm™ Photos enables you to view and manage photos on your handheld or on an expansion card. Use Palm Photos to do the following:

- Locate photos quickly with the Thumbnail and List views.
- Organize photos into albums.
- Play a slide show of your photos.
- Sort photos by name or date.
- View details for each photo.
- Keep track of your thoughts about a photo by entering notes.
- Exchange photos with other devices that use infrared or e-mail communication.
- Use Palm™ Desktop software and HotSync® technology to transfer photos to your handheld, to copy and paste photos into popular computer applications, and to send photos as e-mail attachments or to other applications.

### To open Palm Photos:

1. Press Home .
2. Select the Photo icon .

## Viewing photos

A record in Palm Photos is called a photo. Photos can be a file that you transfer from your computer, store on an expansion card, or receive from another device.

This section covers how to view, manage, and exchange photos that are stored on your handheld or on an expansion card that is seated in the expansion slot. For information on transferring photos from your computer, see [“Installing files and add-on applications”](#) in [Chapter 4](#) and the online Help in Palm Desktop software.

You can use Palm Photos to view the following types of photos:

- JPG files
- BMP files

## Viewing photos in Thumbnail view

Thumbnail view displays miniature versions of your photos so that you can see several photos on the screen at the same time. Use this view to browse through photos or to locate a photo when you don't know the name of the photo.

To view photos in Thumbnail view:

1. Tap the Thumbnail icon .

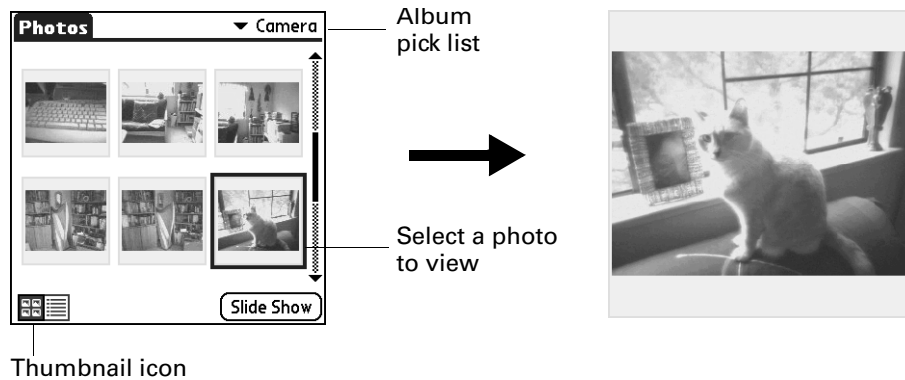

2. Tap the Album pick list in the upper-right corner and select the album you want to view.
3. Tap the thumbnail of the photo you want to view.

**TIP** You can also select a photo with the navigator. Press Select on the navigator to insert the highlight, press Up, Down, Right, or Left to highlight a specific photo, and then press Select to view the photo.

4. Tap anywhere on the screen to return to Thumbnail view.

## Viewing photos in List view

List view displays a list of your photos so that you can see the names and dates associated with your photos. Use this view to locate a photo when you know the name or the date the photo was created.

To view photos in List view:

1. Tap the List icon .

2. Tap the Album pick list in the upper-right corner and select the album you want to view.

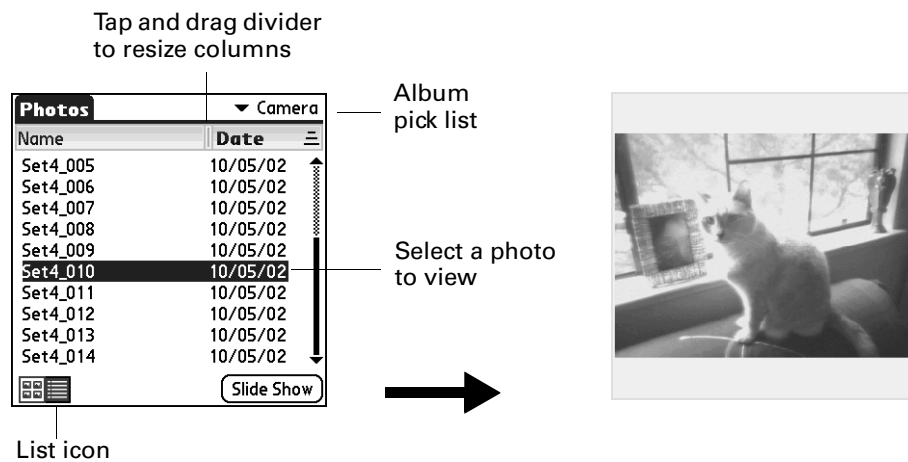

3. Tap the name of the photo you want to view.

**TIP** You can also browse and select a photo with the navigator. See [“Using the navigator”](#) in [Chapter 3](#) for details.

4. Tap anywhere on the screen to return to List view.

## Viewing a slide show



A slide show is a sequential presentation of each of the photos in the current album. You can set the length of time each photo remains on the screen in the Preferences dialog box.

**To view a slide show:**

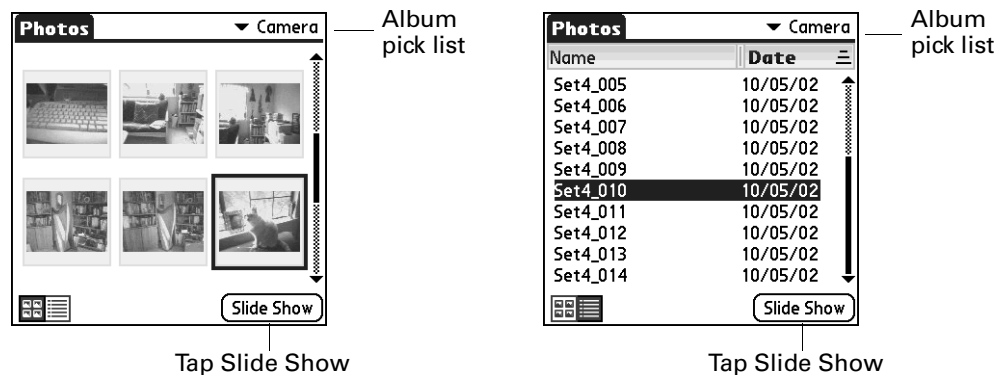

1. Tap the Album pick list in the upper-right corner and select the album you want to view.
2. Tap Slide Show.

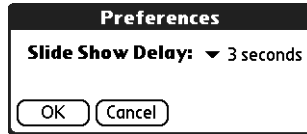

To adjust the delay between photos during a slide show:

1. Press Function  + Menu .
2. Select Options, and then select Preferences.



3. Tap the pick list and select the delay interval: 1 second, 2 seconds, 3 seconds, 5 seconds, or 1 minute.
4. Press Function  + Enter , or tap OK.

## Rotating photos

If a photo appears in the wrong orientation, you can rotate the photo.

To rotate and photo:

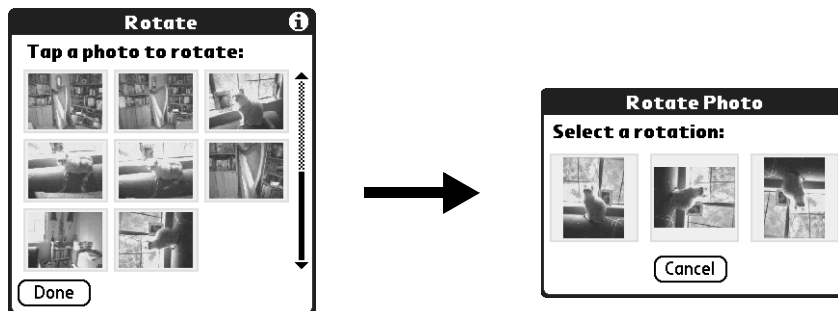

1. Press Command Stroke  + R.

Alternately, press Function  + Menu , select Photo, and then select Rotate.



2. Tap the photo you want to rotate.

**TIP** You can also select a photo with the navigator. Press Select on the navigator to insert the highlight, press Up, Down, Right, or Left to highlight a specific photo, and then press Select to view the photo.

3. Select the new orientation.
4. Press Function  + Enter , or tap Done.

## Viewing photo information

The Photo Details dialog box enables you to view information about a photo and to change the photo name, assign it to an album, add a note about the photo, and delete a photo.

To review photo information:

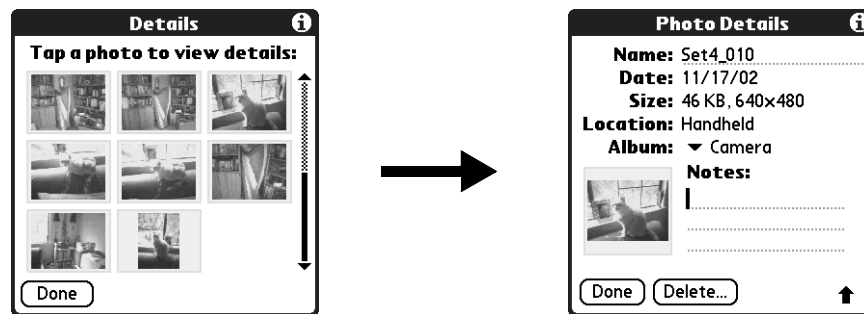

1. Press Command Stroke  + L.

Alternately, press Function  + Menu , select Photo, and then select Details.



2. Tap the photo for which you want to view information.

**TIP** You can also select a photo with the navigator. Press Select on the navigator to insert the highlight, press Up, Down, Right, or Left to highlight a specific photo, and then press Select to view the photo.

3. Review or edit the information.
4. Press Function  + Enter  twice, or tap Done twice.

## Organizing photos

There are several ways you can organize your photos. You can sort photos in the List view, file photos in albums, and copy photos to an expansion card.

## Sorting photos in List view

In List view you can sort photos in ascending or descending order by name or date.

**To sort photos in List view:**

1. Tap a column heading to sort the photos based on that item.

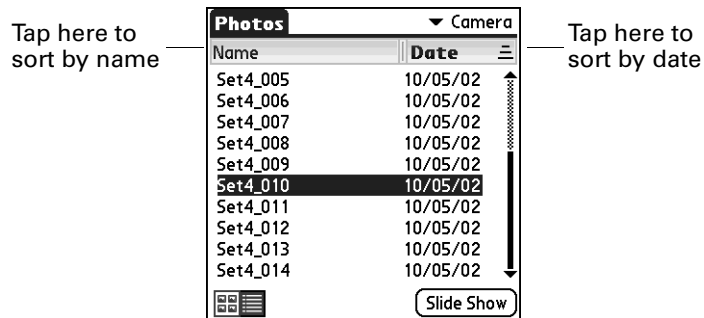

2. Tap the column heading to sort the photos in reverse order.





## Creating an album

The process for creating a new photo album is identical to creating a new category in your other handheld applications.

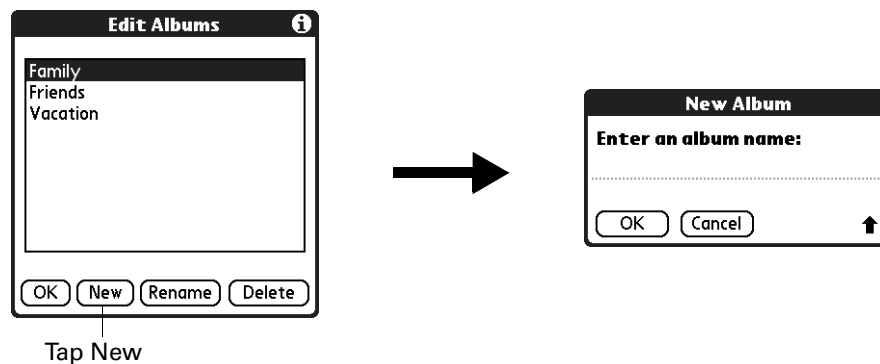
**To create an album:**

1. Tap the Album pick list in the upper-right corner.
2. Select Edit Albums.



3. Tap New.
4. Enter a title for the album.
5. Press Function  + Enter , or tap OK.
6. Press Function  + Enter , or tap Done.

## Filing photos in albums

You can organize the photos on your handheld by filing them into different albums. Since each expansion card is viewed as its own album, you cannot file photos stored on an expansion card in albums.

To file photos in albums:

1. Tap the Album pick list in the upper-right corner and select the album to which you want to add photos.

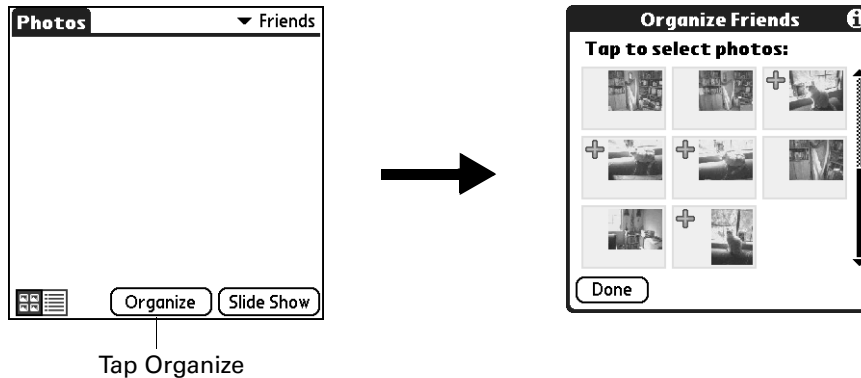

2. Tap Organize.
 

Plus signs appear next to the photos that are part of the selected album.
3. Tap any photos you want to add to the current album.
 

A plus sign appears next to each photo you select.
4. Tap any photos you want to remove from the current album.
 



The plus signs next to the selected photos disappear.
5. Press Function  + Enter , or tap Done.

## Copying photos

The Copy command enables you to make a copy of a photo on your handheld or on an expansion card. If the photo is currently located on your handheld it is copied to an expansion card, and vice versa.

When you copy a photo from an expansion card to your handheld a number is appended to the photo name. If a photo was originally larger than 320 x 320 pixels, then the photo is scaled to a maximum of 320 x 320 pixels and the aspect ratio is maintained.

**To copy photos:**

1. Press Command Stroke  + C.  
Alternately, press Function  + Menu , select Photo, and then select Copy.
2. Tap the photo(s) you want to copy.  
A plus sign appears next to the photo(s) you select.

**TIP** You can also select a photo with the navigator. Press Select on the navigator to insert the highlight, press Up, Down, Right, or Left to highlight a specific photo, and then press Select to view the photo.

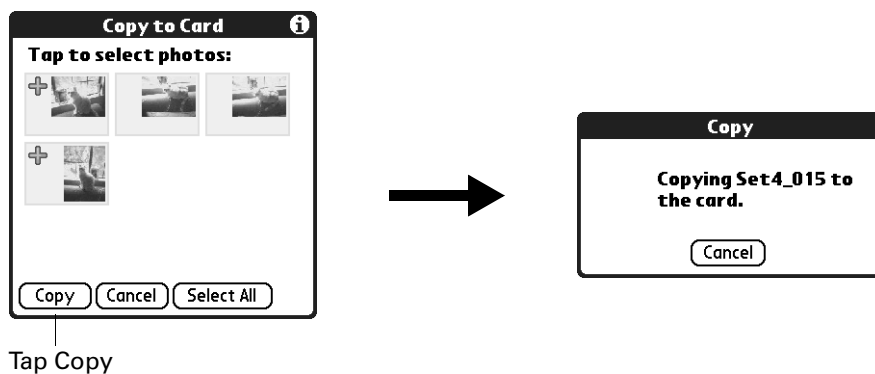

3. Tap Copy.

## Renaming or deleting an album

You can rename or delete any of the albums that you create. You cannot rename or delete the Camera album or the Unfiled album. For information about renaming an expansion card, see [“Renaming a card”](#) in [Chapter 7](#).

When you delete an album all the photos in that album are reassigned to the Unfiled album.



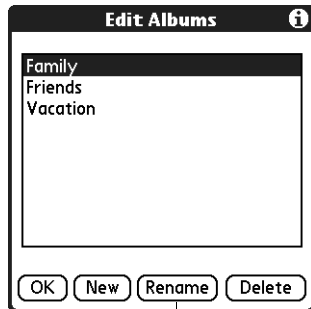

**To rename an album:**

1. Tap the Album pick list in the upper-right corner.
2. Select Edit Albums.



Tap Rename

3. Select the album you want to rename.
4. Tap Rename.
5. Enter the new name.
6. Press Function  + Enter , or tap OK.
7. Press Function  + Enter , or tap Done.

**To delete an album:**

1. Tap the Album pick list in the upper-right corner.
2. Select Edit Albums.





Tap Delete

3. Select the album you want to delete.
4. When the confirmation dialog box appears, tap Delete.
5. Press Function  + Enter , or tap Done.

## Beaming photos

The Beam command enables you to beam photos to other devices that are enabled with infrared technology. The receiving device must have an application that can display photos. For instructions on beaming a single photo, see [“Beaming data”](#) in [Chapter 3](#). Follow the steps below to beam multiple photos.

To beam photos:

1. Press Function  + Menu .
2. Select Photo, and then select Beam.

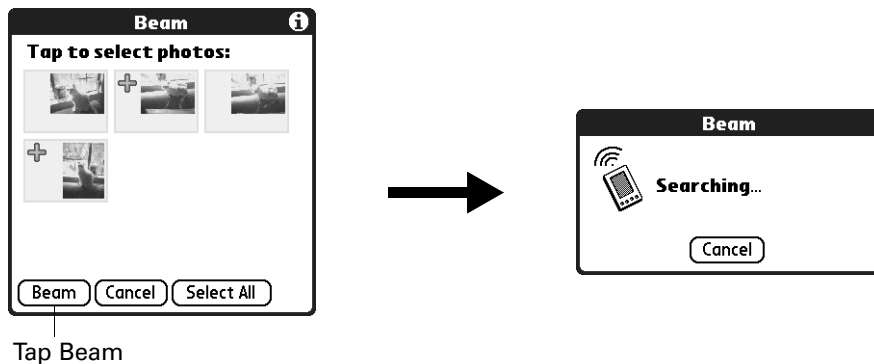

3. Tap the photos you want to beam.

A plus sign appears next to the photos you select.

**TIP** You can also select a photo with the navigator. Press Select on the navigator to insert the highlight, press Up, Down, Right, or Left to highlight a specific photo, and then press Select to select the photo.

4. Tap Beam.
5. Point the IR port on your handheld at the IR port on the receiving device. See [“Beaming data”](#) in [Chapter 3](#) for additional information on beaming data.

## Deleting photos

If you no longer want a photo on your handheld or expansion card, you can delete the photo. Photos that were stored on your handheld and were synchronized with the Desktop software will be removed from Palm Photos on your computer the next time you perform a HotSync operation.

To delete photos:

1. Press Command Stroke  + D.

Alternately, press Function  + Menu , select Photo, and then select Delete.

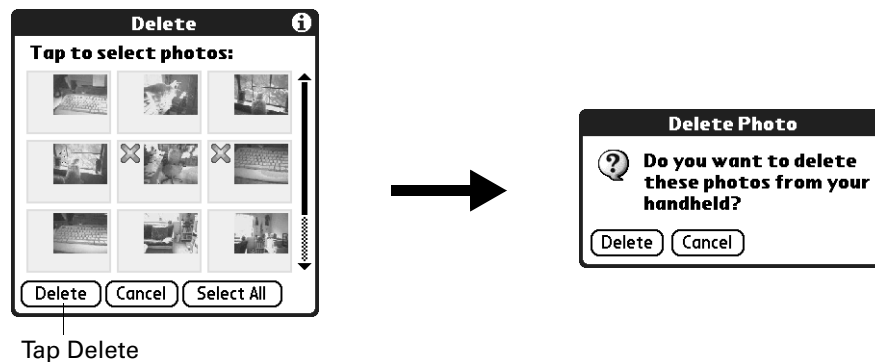

2. Tap the photo(s) you want to delete.

An X sign appears next to the photo(s) you select.

**TIP** You can also select a photo with the navigator. Press Select on the navigator to insert the highlight, press Up, Down, Right, or Left to highlight a specific photo, and then press Select to view the photo.

3. Tap Delete.
4. When the confirmation dialog box appears, tap Delete.

## Working with photos on your computer

After you take manage photos on your handheld and perform a HotSync operation, Palm Desktop software enables you to do any of the following on your Windows computer. See the Palm Desktop software online Help for details.

- View photos in various formats: List, Thumbnails, Details, and Editor with a Handheld preview.
- Drag photos onto the Palm Quick Install icon or the Palm Photos desktop window to install them on your handheld or on an expansion card during the next HotSync operation.
- Modify and delete your photos.

- Organize your photos and add notes.
- Transfer photos to other applications using the Send command or Export command, and import data in popular file formats.

For information on working with photos on your Mac computer, open the Palm folder, open the Documentation folder, and double-click the Photo and Audio Readme file.

## Using Palm Photos menus

Palm Photos menus are shown here for your reference, and Palm Photos features that are not explained elsewhere in this book are described here.

The Photo menu varies slightly when you're viewing the Palm Photos list or thumbnails and an individual photo.

### Photo menu

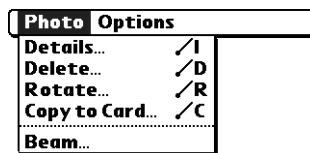

Thumbnail and List view

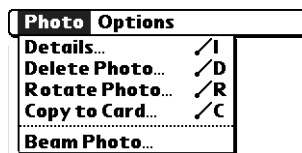

Photo view

### Options menus





**About Photos** Shows version information for Palm Photos.

# Using To Do List

 To Do List is a convenient place to create reminders and prioritize the things that you have to do. Use To Do List for the following:

- Make a quick and convenient list of things to do.
- Assign a priority level to each task.
- Assign a due date for any or all of your To Do List items.
- Assign To Do List items to categories so that you can organize and view them in logical groups.
- Sort your To Do List items by due date, priority level, or category.
- Attach notes to individual To Do List items for a description or clarification of the task.

### To open To Do List:

1. Press Home .
2. Tap the To Do icon .

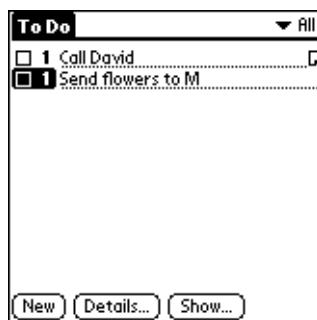

## Creating list items

A To Do List item is a reminder of some task that you have to complete. A record in To Do List is called an *item*.

To create a To Do List item:

1. Do one of the following:
  - Tap New.
  - If no To Do List item is currently selected, begin typing.

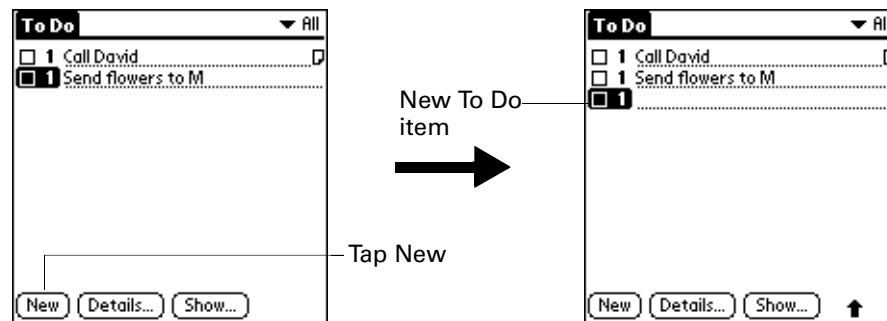

2. Enter the text of the To Do List item. The text can be longer than one line.
3. Tap anywhere onscreen to deselect the To Do List item.

## Setting priority

You can use priority setting for items to arrange the tasks in your To Do List according to their importance or urgency. The default setting for the To Do List is to arrange items by priority and due date, with priority 1 items at the top. If you have a number of items in your list, changing an item's priority setting may move its position in the list.

When you create a new To Do List item, its priority is automatically set to level 1, the highest (most important) level. If you select another item first, however, the item you create appears beneath the selected item and is given the same priority as the selected item.

To set the priority of a To Do List item:

1. Tap the Priority number on the left side of the To Do List item.

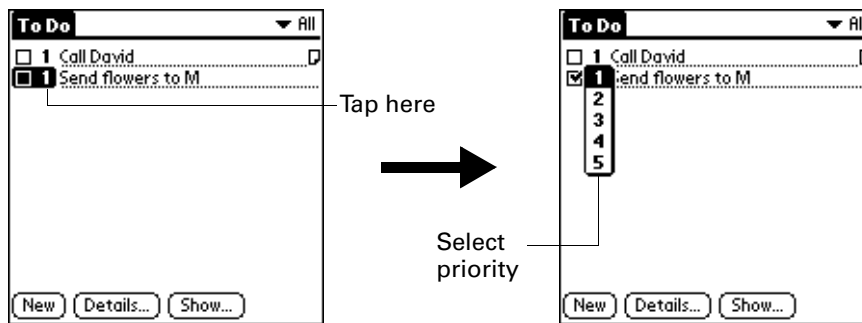

2. Select the Priority number that you want to set (1 is most important).

## Checking off a To Do List item

You can check off a To Do List item to indicate that you've completed it. You can set the To Do List to record the date that you complete the To Do item, and you can choose to show or hide completed items. See ["Setting To Do preferences"](#) later in this chapter.

To check off a To Do List item:

- Tap the check box on the left side of the item.

**TIP** You can also highlight the item you want to check off, and then press Select on the navigator.

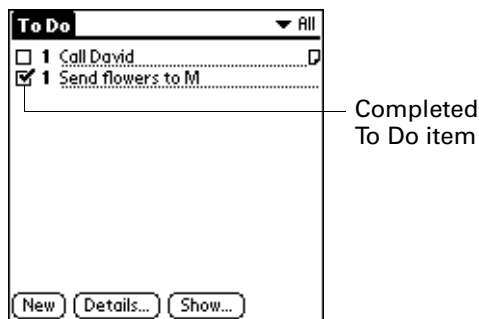

## Changing To Do List item details

The To Do Item Details dialog box enables you to change settings for individual items.

To display the To Do Item Details dialog box:

1. Tap the text of the item whose details you want to change.

**TIP** You can also select an item with the navigator. See [“Using the navigator”](#) in [Chapter 3](#) for details.

2. Tap Details.



## Setting a due date

You can associate a due date with any To Do List item. You can also sort the items that appear in the list based on their due dates.

To set a due date for a To Do List item:

1. In the Details dialog box, tap No Date to open the Due Date pick list.

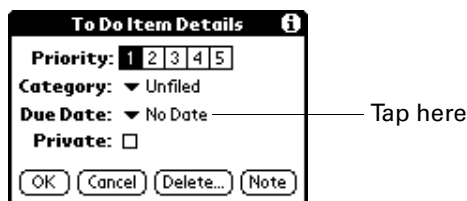

2. Tap the date that you want to assign the item:

<b>Today</b>	Assigns the current date.
<b>Tomorrow</b>	Assigns tomorrow's date.
<b>One week later</b>	Assigns the date exactly one week from the current date.
<b>No Date</b>	Removes the due date from the item.
<b>Choose date</b>	Opens the date selector, where you can choose any date that you want for the item.



3. Press Function  + Enter , or tap OK.

**TIP** If you turn on the Show Due Dates option in the To Do Show options dialog box, you can tap directly on the due date in the To Do List to open the pick list shown in step 2.

## Setting To Do preferences

The To Do Preferences dialog box enables you to control the appearance of To Do List and of To Do items in the Date Book Agenda view.

To change the Preferences settings:

1. In To Do List, tap Show.



2. Select any of the following settings:

**Show Completed Items** Displays your completed items in the To Do List. If you turn off this setting, your To Do items disappear from the list when you complete (checkmark) them.

Items that no longer appear on the list because you turn off this setting have not been deleted. They are still in the memory of your handheld. Purge completed items to remove them from memory.



**Show Only Due Items** Shows only the items that are currently due, are past due, or have no due date specified. When this setting is active, items that are not yet due do not appear in the list until their due dates.

**Record Completion Date** Replaces the due date with the actual date when you complete (checkmark) the item. If you do not assign a due date to an item, the completion date still records when you complete the item.

**Show Due Dates** Displays the due dates associated with items in the To Do List and displays an exclamation mark next to items that remain incomplete after the due date passes.

**Show Priorities** Shows the priority setting for each item.

**Show Categories** Shows the category for each item.

3. Press Function  + Enter , or tap OK.

## Using To Do List menus

To Do List menus are shown here for your reference, and To Do List features that are not explained elsewhere in this book are described here.

See “Using menus” in [Chapter 4](#) for information about choosing menu commands.

### Record menu

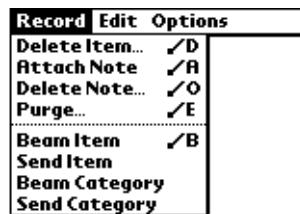

**Send Item** Opens a dialog box where you can choose how you want to send the selected item to another device. The options available depend on the software installed on your handheld.

**Send Category** Opens a dialog box where you can choose how you want to send all records in the selected category to another device. The options available depend on the software installed on your handheld.

### Options menu



**About To Do List** Shows version information for To Do List.

# Using Palm™ VersaMail™ Personal E-mail Software

With the VersaMail™ application, you can send, receive, and manage e-mail on your handheld. This chapter describes how to set up different types of e-mail accounts and explains how to use the many e-mail features in the VersaMail application.

The VersaMail application version 2.5 is the newest offering in the line of Palm™ personal e-mail software applications. Formerly known as MultiMail® software, the VersaMail 2.5 application contains new features that make sending and receiving e-mail messages and managing e-mail accounts easier than ever.

## VersaMail™ application features

Key features of the VersaMail 2.5 application include the following:

- Support for both the Palm™ Tungsten™ C navigator and keyboard, simplifying data entry and navigation
- Support for the built-in 802.11b radio in your handheld, enabling wireless e-mail connectivity
- Enhanced use of color, fonts, styles, and user-selected display options
- Basic HTML formatting display for e-mail messages received in HTML format
- Increased number of file types supported for being sent and received as attachments
- Scheduled retrieval of new e-mail, with notification
- Improved message-addressing capabilities
- Enhanced message security

## Getting started with the VersaMail application

To start using the application, simply press the VersaMail button  on your handheld.

If you are using a Windows computer, the Palm VersaMail HotSync® Conduit is installed automatically when you install the Palm Desktop software. See [“Synchronizing e-mail between the handheld and the desktop”](#) later in this chapter for information on using the conduit.

## Synchronizing an existing username

If you plan to synchronize your Tungsten C handheld with an existing username by performing a HotSync operation, you must do so before you enter your e-mail account information in the VersaMail application. If you enter the e-mail account information first and then synchronize your handheld to an existing username, the e-mail account information you entered is overwritten.

## Upgrading a MultiMail/VersaMail database

If you have previously used a Palm personal e-mail application such as MultiMail SE or MultiMail Deluxe, or used version 2.0 of the VersaMail application, you can upgrade your e-mail database for use with the VersaMail 2.5 application.

**To upgrade an existing e-mail database for use with the VersaMail application:**

1. Perform a HotSync operation with a user profile that contains the existing e-mail database. To do so, press the HotSync button , and then select a profile that contains an e-mail database from the displayed list of users.

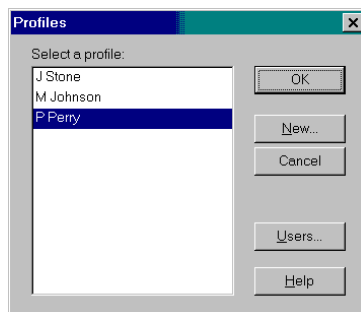

2. Press the VersaMail button  on your handheld.
3. Tap Yes to accept the upgrade.

## Setting up and managing e-mail accounts

With the VersaMail application, you can access e-mail accounts from providers such as Earthlink or Yahoo. You may also access your corporate e-mail with the appropriate mail server configuration. See [“Using a corporate e-mail account”](#) later in this chapter for more information.

You can add up to eight e-mail accounts on your handheld by setting up a connection to an e-mail service provider or synchronizing to a desktop e-mail application. For example, if you have a Yahoo e-mail account with POP access, you can create a new account in the VersaMail application and name that new account Yahoo, so that you can send and receive e-mail on your handheld using your Yahoo account.

### Account and connection types

Two types of e-mail accounts are supported:

- **Network:** You can send and receive e-mail directly to and from your handheld by connecting with an e-mail service provider.
- **Synchronize Only (Windows computers only):** You can download, view, and manage e-mail between the handheld and a desktop e-mail application, such as Microsoft Outlook, by performing a HotSync operation using the cradle/cable. You can't send and receive messages wirelessly or with a modem for an account of this type.

Using a network account, you can set up or access an e-mail account using any of the following connection methods:

- Built-in 802.11b radio enabling you to make a wireless LAN connection
- Bluetooth card product (sold separately) attached through the expansion card slot connection to a mobile phone or local access point that is enabled with Bluetooth technology
- PalmModem<sup>®</sup> accessory (sold separately)
- External modem sled (sold separately)
- Infrared (IR) port on the handheld to infrared port on a mobile phone
- Direct connection to a mobile phone by means of a physical cable
- Handheld cradle connected to your desktop (Windows users only)

## Network e-mail account prerequisites

Before you can set up a network e-mail account, you must do the following:

- Establish the e-mail account with an e-mail service provider. Common providers include Internet service providers (ISPs) such as Earthlink and Prodigy. A provider can also be a wireless GSM or GPRS carrier such as VoiceStream, Cingular, or Vodafone.
- Configure the service connection settings for this account on your handheld using your handheld's WiFi screen (for connections using your handheld's built-in 802.11b radio) or the Network Preferences and Connection Preferences screens (for all other connection types). See [Chapter 18](#) for more information.

You must also have the appropriate prerequisite for the type of connection you want to make, as follows.

Connection Type	Prerequisite
Connection to a wireless LAN using your handheld's built-in 802.11b radio	Proximity to an 802.11b access point.
High-speed GPRS	Bluetooth card and mobile phone enabled with Bluetooth technology. Active GPRS service ordered from your wireless carrier.
GSM dial-up	Bluetooth card and mobile phone enabled with Bluetooth technology. Active wireless service with a GSM carrier. If you are using GPRS, the same carrier generally provides both GSM and GPRS service.  Note that some GSM carriers require you to order a special data service (separate from voice service) to make a network connection.
PalmModem accessory	PalmModem accessory.
External modem sled	Wireless modem accessory.
IR to IR phone	IR-enabled mobile phone.
Direct connection to a phone by means of a physical cable	Connector cable and mobile phone.
Handheld cradle connected to desktop	Handheld cradle and cable (Windows users only).

### Using an ISP

If you are setting up a new e-mail account and have a well-known ISP such as Earthlink or Mindspring, many of the required settings during the account setup are automatically configured.

For other ISPs, you need the following information:

- The protocol used for incoming mail, such as POP or IMAP
- The name of the incoming mail server
- The name of the outgoing mail (SMTP) server
- Whether your e-mail account requires any security, such as SSL, APOP, or ESMTP
- Your e-mail address and password
- The login script (if any) that you need for connecting to your ISP or mail server

**NOTE** Information about your e-mail account is available from the e-mail provider. Depending on the type of e-mail service you have, you may be able to access this information by going to the e-mail provider's web site or by contacting the provider's customer support.

### Using a corporate e-mail account

If you want to access e-mail on your handheld using your corporate e-mail account, you create this account on your handheld in exactly the same way as any other account (see "[Network e-mail account prerequisites](#)" later in this chapter), with one exception: for a corporate e-mail account, you may need to set up a virtual private network (VPN). See "[VPNs](#)" later in this chapter for information.

**NOTE** If your company has an 802.11b network located behind the corporate firewall, you may not need to set up a VPN to access your corporate e-mail account. See the following section for details.

The following considerations apply when setting up a corporate e-mail account:

<b>Username and password</b>	These might be your Windows NT or Windows 2000 username and password, your Lotus Notes ID username and password, or something else. Check with your company's server administrator to obtain the correct username and password. The VersaMail 2.5 application provides strong 128-bit AES encryption for your password.
<b>Protocol</b>	Most corporate mail servers use the IMAP protocol for retrieving mail. In rare cases, your company server may use the POP protocol. Check with your company's server administrator to verify the protocol.
<b>Incoming and outgoing mail server settings</b>	Check with your company's server administrator to obtain these settings.

See [“Creating a network e-mail account”](#) later in this chapter for steps for inputting your username, password, protocol, and incoming and outgoing server settings when you set up your corporate e-mail account.

With a corporate e-mail account, you can access the following types of mail servers, among others:

- Microsoft Exchange
- Lotus Domino
- Sun iPlanet

### VPNs

If you want to access e-mail on your handheld using your corporate e-mail account, you may need to set up a virtual private network (VPN) on your handheld. A VPN enables you to log in to your corporate mail server through the company’s firewall (security layer). Without a VPN, you cannot “break through” the firewall to gain access to the mail server.

You need to set up a VPN to access corporate e-mail in either of the following two situations:

- Your company’s wireless LAN is located outside the firewall.
- Your company’s wireless LAN is located inside the firewall, but you are trying to access the network from outside the firewall (for example, from a public location or at home).

**NOTE** Check with your company’s server administrator to see if a VPN is required to access the corporate network.

See [Chapter 18](#) for instructions on setting up a VPN on your handheld.

**NOTE** You cannot use auto get mail with notification or scheduled sending retry of e-mail with accounts that use a VPN connection. See [“Auto get mail with notification”](#) and [“Send retry”](#) later in this chapter for information.



## Creating a network e-mail account

You create a new account in Account Setup, which guides you through the process.

To create a network e-mail account:

1. Press Function  + Menu , select Accounts, and select Account Setup.

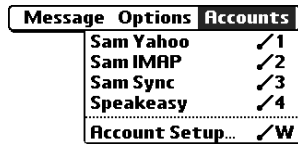

2. Tap New.

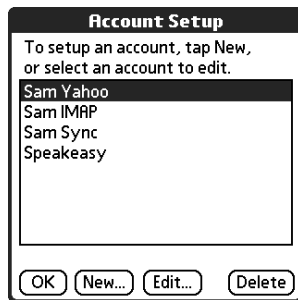

3. Enter the following:

- Account Name** Enter a descriptive name for the account, such as “My Yahoo.”
- Mail Service** Tap the Mail Service pick list and select the provider to which you are connecting. Select Other if your ISP is not listed.
- Protocol** Tap the Protocol pick list and select POP or IMAP. (Most e-mail providers use the POP protocol.)



If the VersaMail application knows the protocol for the mail service you selected, it displays the correct protocol.



4. Tap Next.

### Entering the account username and password

In the next part of the VersaMail Account Setup, you enter the username and password for this account. The VersaMail 2.5 application provides strong 128-bit AES encryption for your password.

To enter the account username and password:

1. Enter the username you use to access your e-mail. This is generally the part of your e-mail address appearing before the @ symbol; it is usually not your entire e-mail address.

2. Tap the Password box, and then enter your password.
3. Tap OK, or press Function  +Enter . The Password box displays the word "Assigned" to indicate that a password has been entered.
4. Tap Next.

### Entering the name of the incoming and outgoing mail server

You need to verify your e-mail address for the account you are accessing, as well as enter the names of the outgoing and incoming mail servers.

To enter mail server settings:

1. If you chose a preconfigured service from the Mail Services pick list on the Account Setup screen, the e-mail address field is completed automatically, based on the username and mail service you entered. Check the address to verify that it is correct, and edit it if necessary.

If you chose Other from the Mail Services pick list on the Account Setup screen, enter the e-mail address for your account.

E-mail address will be filled in automatically if you chose a preconfigured mail service

Mail servers will be filled in automatically if the VersaMail application knows the names based on the mail service you chose

2. Enter the name of your incoming (POP) mail server, such as pop.mail.yahoo.com.

If the VersaMail application knows the incoming mail server name based on the mail service you selected, the correct server name is displayed.

3. Enter the name of your outgoing (SMTP) mail server, such as smtp.mail.yahoo.com.

If the VersaMail application knows the outgoing mail server name based on the mail service you selected, the correct server name is displayed.

4. Tap Next.

5. Do one of the following:

- To accept these mail options and begin using the VersaMail application, tap Done. This takes you to the Inbox of the account you set up. See [“Getting, sending, and managing e-mail”](#) later in this chapter for information on getting and sending e-mail.
- To set up additional mail options, tap Next. Continue with the next set of procedures.

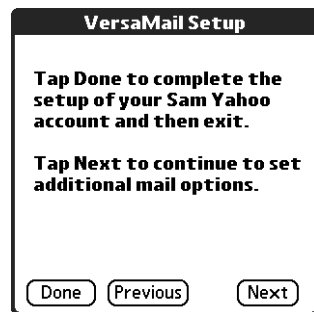

### Setting mail retrieval options for a POP or IMAP account

The next VersaMail Setup screen displays different options depending on whether your mail service uses a POP or an IMAP protocol.

#### To set mail retrieval server options for a POP or IMAP account:

1. (Optional) Select any of the following:

**Get unread mail**     **NOTE** The POP protocol does not support retrieval of unread mail only from the server. If you have a POP e-mail account, the VersaMail application downloads all messages from the server regardless of whether you have read them (for example, on your desktop or on the web), and regardless of whether this check box is selected.

For IMAP accounts, select Get unread mail ONLY to download only unread mail to your handheld. If you don't choose this option and you tap Get & Send, all of your e-mail messages on your provider's mail server are downloaded to your Inbox, including messages you have already read. To get all mail (including mail you have already read) and not just unread mail, deselect Get unread mail ONLY.

**Delete messages on server**     To delete messages on your provider's mail server when they are deleted in the VersaMail application, select the Delete messages on the server when they are deleted in VersaMail check box.

**Leave mail on server (POP account only)**     To get e-mail on your handheld but also leave it on the server so you can view it later on your desktop, select the Leave mail on server check box. For example, if you create an account to receive e-mail from your Yahoo account and select this option, your old Yahoo e-mail is still visible the next time you visit Yahoo.com to access your Yahoo e-mail Inbox.

**Port Number**     The port number setting defaults to 110 for POP and to 143 for IMAP servers. You may need to change the port number if you choose to retrieve incoming mail over a secure connection (see the next bullet item). If you are not sure about the correct port number, check with your mail server administrator.

**Use Secure Connection**     To retrieve incoming mail over a secure (Secure Sockets Layer, or SSL) connection, select the Use Secure Connection check box. See ["Using Secure Sockets Layer \(SSL\)"](#) later in this chapter for information on SSL.

**Maximum Message Size**     To limit the maximum size of an incoming e-mail message, enter the size in kilobytes (KB) for Maximum Message Size. The maximum size of an incoming message is 5KB by default, but you can enter a smaller size. The maximum message size that you can retrieve is 60KB for the body text and 2MB total, including attachments.

## POP accounts

## IMAP accounts

2. Tap Next.

### Setting outgoing mail options

Outgoing mail options are the same for POP and IMAP accounts.

#### To set outgoing mail options:

1. (Optional) Do any of the following:

- |                         |  |
|-------------------------|--|
| <b>Display Name</b>     | Enter the name you want to appear on your outgoing messages, such as "Joe Smith."  |
| <b>Reply To Address</b> | Enter the e-mail address that you want recipients to see and reply to on your e-mail messages, only if this is different from the e-mail address from which you are sending the message. For example, if you are sending a message from me@yahoo.com but you want recipients to reply to me@earthlink.net, enter the reply-to address here. Reply To Address makes it look as though the e-mail came from the address you entered. |
| <b>BCC</b>              | Select the BCC check box to send a blind copy of any e-mail message you send to another e-mail address. The blind copy e-mail address is not seen by the other recipients of the message. For example, if you want a copy of all messages you send from your handheld to be sent to your corporate e-mail account, enter that e-mail address.  |

2. Tap Next.

### Adding a signature

If you want, you can add a signature to each e-mail message you send. For example, you can enter your name and telephone number so that they appear on each message you send.

#### To add a personal signature:

1. Tap the Attach Signature to messages check box, and then enter the text of the signature.

This signature is attached to all your outgoing e-mail.

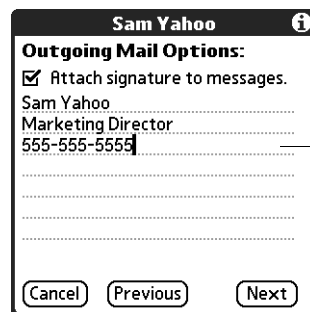

Signature lines appear only if check box is selected

2. Tap Next.

### Setting advanced outgoing mail options

You can set additional outgoing mail options.

#### To set advanced outgoing mail options:

1. (Optional) Select either of the following:

**Port Number** The default is 25, the port number most SMTP servers use. If you are not sure about the correct port number, check with your mail server administrator.

**Authentication** Select the My server requires authentication (ESMTP) check box if the outgoing server (SMTP) requires authentication. Check with your system administrator before selecting this option. See [“Adding ESMTP to an account”](#) later in this chapter for information. If you select this option, username and password fields appear. These fields are already filled in based on the account information you entered previously. In most cases, the information displayed is correct; however, occasionally your authentication username and/or password is different from your account username or password. Check with your e-mail service provider for authentication username and password information.

If you need to enter new information, enter a username and/or tap the Password box and enter a password, and then tap OK.

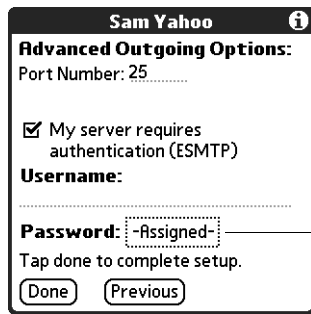

Username and Password fields appear only if ESMTP check box is selected

2. Tap Done, or press Function  + Enter .

### Testing your new account



After you finish setting up a new e-mail account, the Inbox of the account you just created is displayed. You can test whether the e-mail account is set up and working properly by tapping Get Mail. See [“Getting e-mail by subject or getting the entire message”](#) later in this chapter for more information.

## Creating a synchronize-only account

**NOTE** You must be using a Windows computer to use a synchronize-only account.

A synchronize-only e-mail account enables you to download, view, and manage e-mail between the handheld and a desktop e-mail application, such as Microsoft Outlook, by performing a HotSync operation by means of the cradle/cable. You can't send and receive messages wirelessly or with a modem for any account of this type.

To create a synchronize-only e-mail account:

1. Press Function  + Menu , select Accounts, and then select Account Setup.

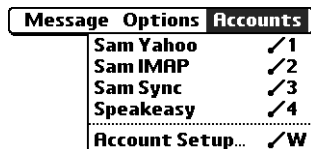

2. Tap New.

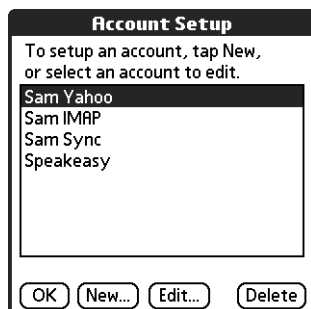

3. Do the following:

- Account Name** Enter a descriptive name for this account, such as “My Yahoo.”
- Mail Service** Tap the Mail Service pick list and select the provider to which you are connecting. Select Other if your ISP is not listed.
- Protocol** Tap the Protocol pick list and select POP or IMAP. (Most mail providers use the POP protocol.)

If the VersaMail application knows the protocol for the mail service you selected, it displays the correct protocol.

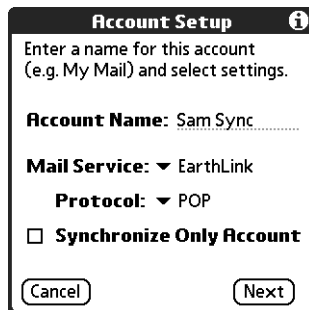

4. On the same screen, select the Synchronize Only Account check box.

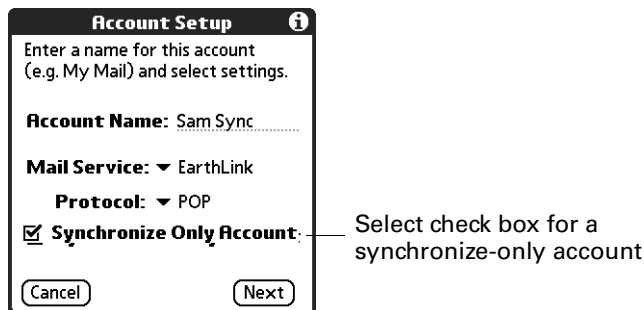

5. Tap Next.





## Entering the account username and password

In the next part of the VersaMail Account Setup, you enter the username and password for this account. The VersaMail 2.5 application provides strong 128-bit AES encryption for your password.

To enter the account username and password:

1. Enter the username you use to access your e-mail. This is generally the part of your e-mail address appearing before the @ symbol; it is usually not your entire e-mail address.

2. Tap the Password box, and then enter your password.
3. Tap OK, or press Function  + Enter . The Password box displays the word "Assigned" to indicate that a password has been entered.
4. Tap Next.

## Entering the name of the incoming and outgoing mail server

You need to enter your e-mail address for the account you are accessing, as well as the names of the outgoing and incoming mail servers.

To enter mail server settings:

1. If you chose a preconfigured service from the Mail Services pick list on the Account Setup screen, the e-mail address field is completed automatically, based on the username and mail service you entered. Check the address to verify that it is correct, and edit it if necessary.

If you chose Other from the Mail Services pick list on the Account Setup screen, enter the e-mail address for your account.

E-mail address will be filled in automatically if you chose a preconfigured mail service

Mail servers will be filled in automatically if the VersaMail application knows the names based on the mail service you chose

2. Enter the name of your incoming (POP) mail server, such as pop.mail.yahoo.com.

If the VersaMail application knows the incoming mail server name based on the mail service you selected, the correct server name is displayed.

3. Enter the name of your outgoing (SMTP) mail server, such as smtp.mail.yahoo.com.

If the VersaMail application knows the outgoing mail server name based on the mail service you selected, the correct server name is displayed.

4. Tap Next.

5. Do one of the following:

- To accept these mail options and begin using the VersaMail application, tap Done. After you finish setting up a synchronize-only e-mail account, you need to configure this account on your desktop. See [“Configuring an account in HotSync Manager”](#) later in this chapter for information. You will not be able to synchronize e-mail between your handheld and your desktop until you configure the account on your desktop.
- To set up additional mail options, tap Next. Continue with the next set of procedures.

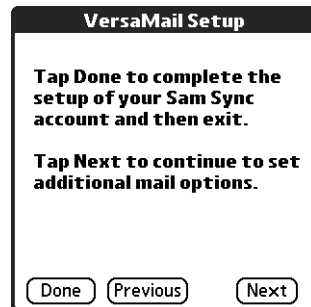

## Setting mail retrieval options for a POP or IMAP account

The next VersaMail Setup screen displays different options, depending on whether your mail service uses a POP or an IMAP protocol.

### To set mail retrieval server options for a POP or IMAP account:

1. (Optional) Select any of the following:

**Get unread mail** **NOTE** The POP protocol does not support retrieval of unread mail only from the server. If you have a POP e-mail account, the VersaMail application downloads all messages from the server regardless of whether you have read them (for example, on your desktop or on the web), and regardless of whether this check box is selected.

For IMAP accounts, select Get unread mail ONLY to download only unread mail to your handheld. If you don't choose this option and you tap Get & Send, all of your e-mail messages on your provider's mail server are downloaded to your Inbox, including messages you have already read. To get all mail (including mail you have already read) and not just unread mail, deselect Get unread mail ONLY.

**Delete messages on server** To delete messages on your provider's mail server when they are deleted in the VersaMail application, select the Delete messages on the server when they are deleted in VersaMail check box.

**Leave mail on server (POP account only)** To get e-mail on your handheld but also leave it on the server so you can view it later on your desktop, select the Leave mail on server check box. For example, if you create an account to receive e-mail from your Yahoo account and select this option, your old Yahoo e-mail is still visible the next time you visit Yahoo.com to access your Yahoo e-mail Inbox.

**Port Number** The port number setting defaults to 110 for POP and to 143 for IMAP servers. You may need to change the port number if you choose to retrieve incoming mail over a secure connection (see the next bullet item). If you are not sure about the correct port number, check with your mail server administrator.

**Use Secure Connection** To retrieve incoming mail over a secure (Secure Sockets Layer, or SSL) connection, select the Use Secure Connection check box. See ["Using Secure Sockets Layer \(SSL\)"](#) later in this chapter for information on SSL.

**Maximum Message Size**

To limit the maximum size of an incoming e-mail message, enter the size in kilobytes (KB) for Maximum Message Size. The maximum size of an incoming message is 5KB by default, but you can enter a smaller size. The maximum message size that you can retrieve is 60KB for the body text and 2MB total, including attachments.

POP accounts

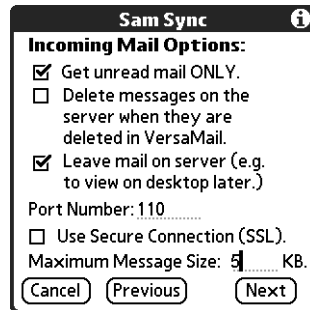

IMAP accounts

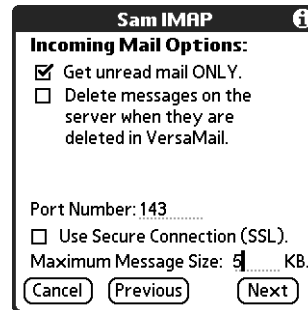

2. Tap Next.

**Setting outgoing mail options**

Outgoing mail options are the same for POP and IMAP accounts.

To set outgoing mail options:

1. (Optional) Enter or select any of the following:

**Display Name** Enter the name you want to appear on your outgoing messages, such as “Joe Smith.”

**Reply To Address** Enter the e-mail address that you want recipients to see and reply to on your e-mail messages, only if this is different from the e-mail address from which you are sending the message. For example, if you are sending a message from “me@yahoo.com” but you want recipients to reply to “me@earthlink.net,” enter the reply-to address here. Reply To Address makes it look as though the e-mail came from the address you entered.

**BCC** Select the BCC check box to send a blind copy of any e-mail message you send to another e-mail address. The blind copy e-mail address is not seen by the other recipients of the message. For example, if you want a copy of all messages you send from your handheld to be sent to your corporate e-mail account, enter that e-mail address.

**Sam Sync** ⓘ

**Outgoing Mail Options:**

Your Name (for display only):  
Sam Sync

Reply To Address: (if different than current account)

BCC a copy of outgoing msgs to:  
sam@samsync.com

Cancel Previous Next

2. Tap Next.

### Adding a signature

If you want, you can add a signature to each e-mail message you send. For example, you can enter your name and telephone number so that they appear on each message you send.

#### To add a personal signature:

1. Tap the Attach Signature to messages check box, and then enter the text of the signature.

This signature is attached to all your outgoing e-mail.

**Sam Sync** ⓘ

**Outgoing Mail Options:**

Attach signature to messages.

Sam Sync  
Marketing Director  
555-555-5555

Signature lines appear only if check box is selected

Cancel Previous Next

2. Tap OK, or press Function  + Enter .

### Setting advanced outgoing mail options

You can set additional outgoing mail options.

#### To set advanced outgoing mail options:

1. (Optional) Select either of the following:

**Port Number**      The default is 25, the port number most SMTP servers use. If you are not sure about the correct port number, check with your mail server administrator.

**Authentication**      Select the My server requires authentication (ESMTP) check box if the outgoing server (SMTP) requires authentication. Check with your system administrator before selecting this option. See [“Adding ESMTP to an account”](#) later in this chapter for information. If you select this option, username and password fields appear. These fields are already filled in based on the account information you entered previously. In most cases, the information displayed is correct; however, occasionally your authentication username and/or password is different from your account username or password. Check with your e-mail service provider for authentication username and password information.

If you need to enter new information, enter a username and/or tap the Password box and enter a password, and then tap OK.

The screenshot shows a dialog box titled "Sam Sync" with an information icon. The main heading is "Advanced Outgoing Options:". Below this, it shows "Port Number: 25" followed by a dotted line. A checkbox labeled "My server requires authentication (ESMTP)" is checked. Below that is the label "Username:" followed by a dotted line. The "Password:" field contains the text "-Unassigned-". At the bottom, it says "Tap done to complete setup." and has two buttons: "Done" and "Previous".

Username and Password fields appear only if ESMTP check box is selected

2. Tap Done, or press Function  + Enter .



### Configuring your synchronize-only account

After you finish setting up a synchronize-only e-mail account, you need to configure this account on your desktop. See [“Configuring an account in HotSync Manager”](#) later in this chapter for information. You will not be able to synchronize e-mail between your handheld and your desktop until you configure the account on your desktop.

## Editing e-mail accounts

From time to time, you may need to edit information about one of the e-mail accounts you set up.

To select the account to edit:

1. Press Function  + Menu .
2. Select Accounts.
3. Select Account Setup.
4. Tap the name of the account to edit, and then tap Edit.



To edit an account:

1. On the Account Setup screen, change any of the following:

- |                     |   |
|---------------------|---|
| <b>Account Name</b> | Enter a descriptive name for this account, such as "My Yahoo."  |
| <b>Mail Service</b> | Tap the Mail Service pick list and select the provider to which you are connecting. Select Other if your ISP is not listed. |
| <b>Protocol</b>     | Tap the Protocol pick list and select POP or IMAP. (Most mail providers use the POP protocol.)                              |

If the VersaMail application knows the protocol for the mail service you selected, it displays the correct protocol.





2. Tap Next.

### Changing the account username and password

In the next part of the VersaMail Account Setup, you can change the username and/or password for this account. The VersaMail 2.5 application provides strong encryption for your password.

To edit the account username and password:

1. (Optional) Enter a new username for accessing your e-mail. This is generally the part of your e-mail address appearing before the @ symbol; it is usually not your entire e-mail address.

2. (Optional) Tap the Password box, and then enter a new password. The Password box displays the word “Assigned” to indicate that a password has been entered.
3. Tap OK, or press Function  + Enter . The Password box displays the word “Assigned” to indicate that a password has been entered.
4. Tap Next.

### Editing the names of the incoming and outgoing mail servers

If your e-mail address or the names of the outgoing and incoming mail servers have changed or have been entered incorrectly, you can edit the address or the server names.

To edit mail server settings:

1. (Optional) Enter a new e-mail address for the account you are accessing, such as “examplename@yahoo.com.”

2. (Optional) Enter the new or correct name of your incoming (POP) mail server, such as pop.mail.yahoo.com.



If the VersaMail application knows the incoming mail server name based on the mail service you selected, the correct server name is displayed.

3. (Optional) Enter the new or correct name of your outgoing (SMTP) mail server, such as smtp.mail.yahoo.com.

If the VersaMail application knows the outgoing mail server name based on the mail service you selected, the correct server name is displayed.

4. Tap Next.
5. Do one of the following:
  - To accept these mail options and begin using the VersaMail application, tap Done. This takes you to the Inbox of the account you set up. See [“Getting, sending, and managing e-mail”](#) later in this chapter for information on getting and sending e-mail.
  - To edit additional mail options, tap Next. Continue with the next set of procedures.

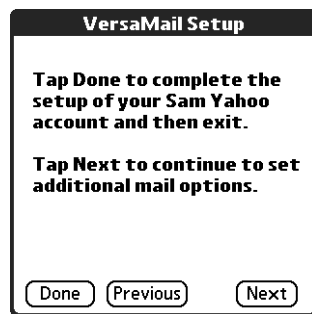

### Editing mail retrieval options for a POP or IMAP account

The next VersaMail Setup screen displays different options, depending on whether your mail service uses a POP or an IMAP protocol.

**To edit mail retrieval server options for a POP or IMAP account:**

1. (Optional) Change any of the following:

**Get unread mail** **NOTE** The POP protocol does not support retrieval of unread mail only from the server. If you have a POP e-mail account, the VersaMail application downloads all messages from the server regardless of whether you have read them (for example, on your desktop or on the web), and regardless of whether this check box is selected.

For IMAP accounts, select Get unread mail ONLY to download only unread mail to your handheld. If you don't choose this option and you tap Get & Send, all of your e-mail messages on your provider's mail server are downloaded to your Inbox, including messages you have already read. To get all mail (including mail you have already read) and not just unread mail, deselect Get unread mail ONLY.

- Delete messages on server**      To delete messages on your provider’s mail server when they are deleted in the VersaMail application, select the Delete messages on the server when they are deleted in VersaMail check box.
- Leave mail on server (POP account only)**      To get e-mail on your handheld but also leave it on the server so you can view it later on your desktop, select the Leave mail on server check box. For example, if you create an account to receive e-mail from your Yahoo account and select this option, your old Yahoo e-mail is still visible the next time you visit Yahoo.com to access your Yahoo e-mail Inbox.
- Port Number**      The port number setting defaults to 110 for POP and to 143 for IMAP servers. You may need to change the port number if you choose to retrieve incoming mail over a secure connection (see the next bullet item). If you are not sure about the correct port number, check with your mail server administrator.
- Use Secure Connection**      To retrieve incoming mail over a secure (Secure Sockets Layer, or SSL) connection, select the Use Secure Connection check box. See [“Using Secure Sockets Layer \(SSL\)”](#) later in this chapter for information on SSL.
- Maximum Message Size**      To limit the maximum size of an incoming e-mail message, enter the size in kilobytes (KB) for Maximum Message Size. The maximum size of an incoming message is 5KB by default, but you can enter a smaller size. The maximum message size that you can retrieve is 60KB for the body text and 2MB total, including attachments.

POP accounts

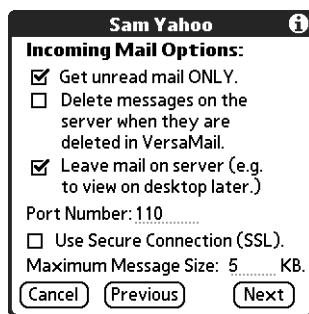

IMAP accounts

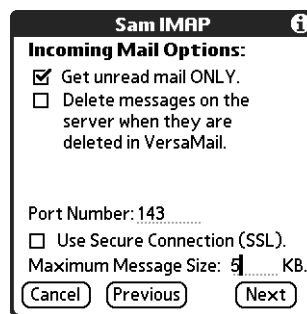

2. Tap Next.

## Editing outgoing mail options

Outgoing mail options are the same for POP and IMAP accounts.

### To edit outgoing mail options:

1. (Optional) Change any of the following:

**Display Name** Enter the name you want to appear on your outgoing messages, such as “Joe Smith.”

**Reply To Address** Enter the e-mail address that you want recipients to see and reply to on your e-mail messages, only if this is different from the e-mail address from which you are sending the message. For example, if you are sending a message from me@yahoo.com but you want recipients to reply to me@earthlink.net, enter the reply-to address here. Reply To Address makes it look as though the e-mail came from the address you entered.

**BCC** Select the BCC check box to send a blind copy of any e-mail message you send to another e-mail address. The blind copy e-mail address is not seen by the other recipients of the message. For example, if you want a copy of all messages you send from your handheld to be sent to your corporate e-mail account, enter that e-mail address.

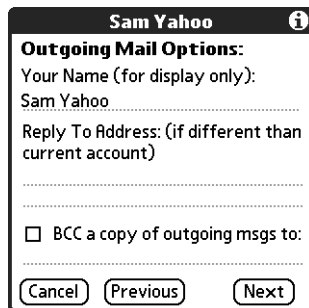

The screenshot shows a dialog box titled "Sam Yahoo" with an information icon. The dialog is titled "Outgoing Mail Options:" and contains the following fields and options:

- "Your Name (for display only):" with the text "Sam Yahoo" entered.
- "Reply To Address: (if different than current account)" with a blank text field.
- A checkbox labeled "BCC a copy of outgoing msgs to:" which is currently unchecked.
- At the bottom, there are three buttons: "Cancel", "Previous", and "Next".

2. Tap Next.

### Editing a signature

If you added a signature to the e-mail messages you send, you can edit the signature. For example, you can change your name or the telephone number that appears in each message you send.

#### To edit a personal signature:

1. (Optional) To add a signature, select the Attach Signature to messages check box, and then enter the text of the signature.

To edit an existing signature name, phone number, and so on, edit the information on the signature lines.

To remove a signature, deselect the Attach Signature to messages check box.

This signature is attached to all your outgoing e-mail.



2. Tap Next.

### Editing advanced outgoing mail options

You can change additional outgoing mail options.

#### To edit advanced outgoing mail options:

1. (Optional) Change either of the following:

**Port Number**      The default is 25, the port number most SMTP servers use. If you are not sure about the correct port number, check with your mail server administrator.

**Authentication** Select the My server requires authentication (ESMTP) check box if the outgoing server (SMTP) requires authentication. Check with your system administrator before selecting this option. See “[Adding ESMTP to an account](#)” later in this chapter for information. If you select this option, username and password fields appear. These fields are already filled in based on the account information you entered previously. In most cases, the information displayed is correct; however, occasionally your authentication username and/or password is different from your account username or password. Check with your e-mail service provider for authentication username and password information.

If you need to enter new information, enter a username and/or tap the Password box and enter a password, and then tap OK.

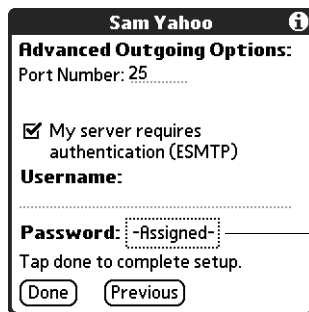

Username and Password fields appear only if ESMTP check box is selected



2. Tap OK, or press Function  + Enter .

## Deleting an e-mail account

When you delete an account in the VersaMail application, the account is removed from your handheld. The account still exists on the server. For example, deleting your Yahoo account from the VersaMail application deletes only the account from your handheld. Your e-mail account still exists at Yahoo.com.

**NOTE** You can delete all but one of your e-mail accounts; you must have at least one account.

To delete an account:

1. Press Function  + Menu .
2. Select Accounts.

3. Select Account Setup.

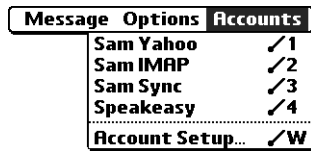

4. Tap the name of the account you want to delete, and then tap Delete.



5. Tap Yes in the Delete Confirmation dialog box to delete the account and all associated e-mail messages.



6. Tap OK, or press Function  + Enter .

After you perform the next HotSync operation, the memory associated with an account and its messages is released.

## Selecting a different service for a given e-mail account

When you set up connections on your handheld (on the Connection Preferences screen), you pair each connection with a network service (on the Network Preferences screen) and then select one of these services to be the default for all network activity (sending and receiving e-mail, surfing the web, and so on) on your handheld. By default, the VersaMail application uses this service for sending and receiving messages for all e-mail accounts you set up. See [Chapter 18](#) for information on setting up the default service for your handheld.

However, for any given e-mail account, you have the option of switching to a different service for use with that account only. For example, the default service you have selected for your handheld may be called My VPN and may use your handheld's built-in 802.11b radio to make a dial-up connection to your corporate mail server. You may also have set up an e-mail account called My Earthlink, which runs on the My VPN connection by default. However, if you travel into an area that

has GPRS coverage, you may want to switch your My Earthlink account to the service called Earthlink GPRS, which connects to a GPRS service using a Bluetooth card product (sold separately) inserted into your handheld's expansion card slot.

To set up a service for a given e-mail account (different from the default service for your handheld):

1. From the Inbox of the account you want to switch, tap Get Mail.

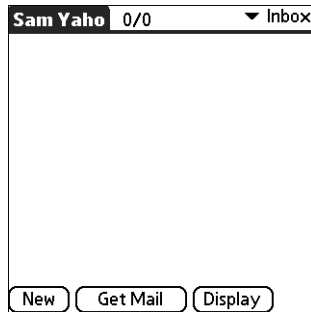

2. Tap Details.



3. Tap the Always connect using check box. A pick list of available services appears. The currently used connection is displayed by default.



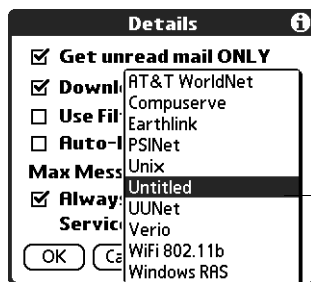

Tap to change the service connection for this e-mail account only from your default handheld service connection

4. Select the connection you want to switch to from the Service pick list.



Select a new service connection for this e-mail account only

5. Tap OK (alternately, press Function  + Enter ) again. If there is an existing service connection, it is disconnected and the new connection is initiated. The VersaMail application sends and checks for any new e-mail using the new connection.

When you exit the VersaMail application, the new service disconnects. When you reopen the application, the e-mail account you selected (My Earthlink in this example) continues to connect using the new connection (Earthlink GPRS in this example) until you either select a new service or deselect the Always connect using check box. If you deselect the Always connect using check box, the e-mail account (My Earthlink) connects using the default handheld service (My VPN in this example).

The Always connect using check box changes the connection service for the selected e-mail account only. You must follow the preceding procedure for each e-mail account whose connection you want to switch from the default connection on your handheld.

## Troubleshooting account access problems

Occasionally you may experience problems using an e-mail account after you set it up. If you followed the account setup procedures described in [“Setting up and managing e-mail accounts”](#) earlier in this chapter but experience problems using the account, you may need to verify that the account complies with your e-mail provider’s requirements. See [Appendix B](#) for troubleshooting information for account access problems.

## Getting, sending, and managing e-mail

Getting and sending e-mail on your handheld is easy and helps you keep your business and personal life organized. You can get and send e-mail by simply tapping one button on the handheld.

You can manage the messages in your e-mail accounts by moving messages between folders, deleting old e-mail messages individually or in groups, and marking messages as read or unread.

This section explains how to do the following:

- Get and send e-mail for your e-mail accounts
- View and send e-mail attachments, such as text or Microsoft Word documents, wirelessly





## Getting e-mail

You can get e-mail subjects only—the message size, author, and subject—or you can get entire messages immediately. If you choose to get message subjects only and want to read a full message, you can get more of the message. If you choose to get the entire message, the body text of the message will be downloaded up to the maximum message size you select. See “[Reading e-mail](#)” later in this chapter for information.

### Choosing the e-mail account and displaying the Inbox

To view the e-mail in an account, you must switch to that account and then get the e-mail. For example, if you want to collect and view the e-mail from your Yahoo account, you switch to the account created to retrieve e-mail from your Yahoo account.

To display an account and its Inbox:

1. In your Inbox or on another folder screen, press Function  + Menu .
2. Select Accounts.

Message	Options	Accounts
Sam Yahoo		/1
Sam IMAP		/2
Sam Sync		/3
Speakeasy		/4
Account Setup...		/W

3. Tap the name of the account you want from the list.

Alternately, press Command  + the number of the account you want from the list.

**TIP** You can also press the VersaMail button  repeatedly to scroll through the accounts you have configured in the VersaMail application until you get to the account you want.

4. Tap the folders pick list, and tap Inbox if the Inbox is not displayed.

Sam Yahoo	0/0	All
		Inbox
		Outbox
		Drafts
		Sent
		Trash
		Edit Folders...

New Get Mail Display

### Getting e-mail by subject or getting the entire message

When you get e-mail messages, you can choose to get the subject only or to get the entire message. You can also use the Details dialog box to select options for getting unread e-mail only, downloading attachments, using filters, and more.

To get e-mail messages:

1. Tap Get Mail.

If you have e-mail stored in your Outbox, tap Get & Send.

2. In the Get Mail dialog box, tap Subjects Only to download subjects only, or tap Messages to download entire messages.





**TIP** You can deactivate the Get Mail dialog box by using VersaMail Preferences. See [“Setting preferences for getting and deleting e-mail”](#) later in this chapter.

3. (Optional) Tap Details and select options for retrieving unread e-mail, downloading attachments, using filters, auto-disconnect, maximum download size, and default connection type for this account. Tap OK.

**NOTE** See [“Creating mail filters”](#) later in this chapter for more information about filters. See [“Setting advanced account preferences”](#) earlier in this chapter for information on the auto-disconnect feature. See [“Selecting a different service for a given e-mail account”](#) earlier in this chapter for information on setting a default connection type.



**NOTE** The maximum size of an incoming message is 5KB by default.



4. (Optional) For IMAP accounts, you have the option of synchronizing IMAP folders from the Get Mail dialog box. See [“Wireless IMAP folder synchronization”](#) later in this chapter for information.
5. Tap OK, or press Function  + Enter .

6. (Optional) If you are retrieving mail using a VPN connection, you may be asked to enter the username and password you use to log in to the VPN. If so, enter the username and password. See “VPNs” earlier in this chapter for more information.
7. The Getting Messages dialog box shows updates as your e-mail is downloaded. When the Getting Messages dialog box disappears, another dialog box appears and displays the number of new e-mail messages.



8. Tap OK, or press Function  + Enter . A list of your e-mail appears in the Inbox.

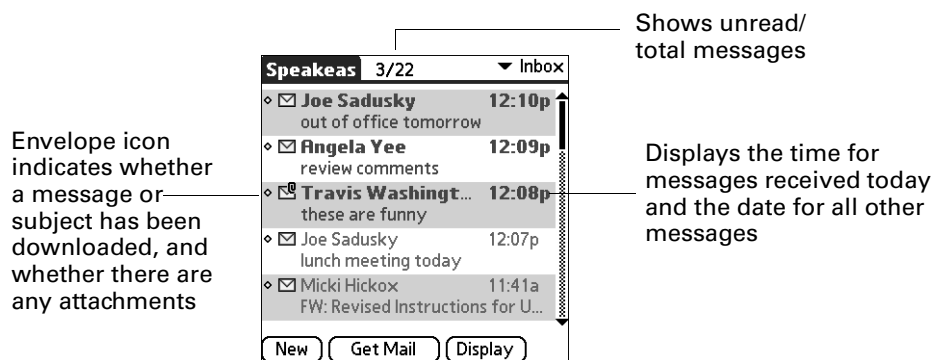

## Auto get mail with notification

You can set up the VersaMail application to automatically search for new mail on a regular schedule for an e-mail account. The auto get mail feature automatically retrieves new messages and downloads them to your handheld, without needing to tap Get Mail.

If auto get downloads any new messages, your handheld notifies you by blinking an indicator light, beeping, or vibrating. The handheld also displays a visual list of notifications on the Reminders screen.

The auto get feature downloads the first 3KB of each message. If a message is larger than 3KB, tap the More button on the message screen to download and view the entire message.

Auto get mail recognizes any filter criteria you have set up for downloading messages to your handheld. “Managing mail filters” later in this chapter for information. Any messages that do not meet the filter criteria are not downloaded

during an auto get. To retrieve messages that do not conform to filter criteria, perform a manual get with all filters turned off.

If auto get is occurring and you turn your handheld off or the connection to your e-mail service provider is disconnected, the auto get fails. If you are attempting an auto get over a network from a public location, you must be in range of a network access point for the auto get to work.

### Scheduling auto get mail

When setting up a schedule, you select the interval for retrieving mail, the start and end times for retrieving mail, and the days on which scheduled e-mail retrieval should take place.

You can set up different schedules for each of your e-mail accounts, but you can set up only one schedule for an account. For example, if you set up a schedule for mail retrieval on weekdays for your Yahoo account, you cannot set up a separate schedule for weekends on the same account.

If more than one scheduled auto get takes place at the same time (for example, for two separate e-mail accounts), the retrievals take place in the following order:

- Any past-due auto get (for example, a retry of an earlier failed auto get)
- Current retrievals according to the order of e-mail accounts (#1, #2, and so on)

**NOTE** The auto get feature is not supported for VPN or SSL connections. It is also not supported if you have configured the security preferences on your handheld to encrypt databases on the handheld. For some nonsupported connection types, the Options menu does not display the auto get mail option; for others, if you try to set up an auto get schedule, an error message appears.



To set up a scheduled auto get mail:

1. On the message screen, Tap the Menu icon .
2. Select Options.

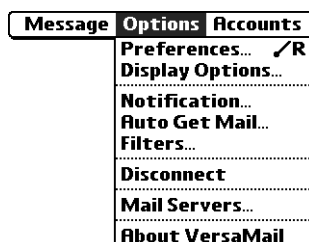

3. Select Auto Get Mail.

4. Select the Get mail automatically check box.



5. Set schedule options:

**Interval** Tap the Every pick list and select the time interval, from 15 minutes to 12 hours. See [“Resource issues with auto get mail”](#) later in this chapter for information on setting the interval.

**Start Time** Tap the Start Time box, tap to enter the start time hour and minute, and tap to enter AM or PM. Then tap OK.

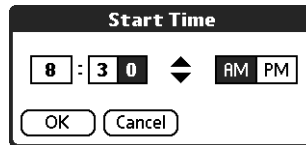

**End Time** Tap the End Time box, tap to enter the end time hour and minute, and tap to enter AM or PM. Then tap OK.

**Days** Tap the days you want the schedule to be active. You can choose any number of days, but you can set up only one schedule for each e-mail account.

6. Tap OK.
7. (Optional) Tap Get Mail. You should perform a manual Get Mail after setting up a scheduled auto get. This ensures that only new messages are retrieved during auto get.

**TIP** Alternately, if you have configured an e-mail account to synchronize messages between your handheld and your desktop, you can perform a HotSync operation after setting up a scheduled auto get to ensure that only new messages will be retrieved during auto get. See [“Synchronizing e-mail between the handheld and the desktop”](#) later in this chapter for configuration information.



### Auto get notifications

The auto get mail feature provides three types of alerts during and after message retrieval:

- Depending on the connection type, a series of status messages may appear during the auto get connection and mail retrieval process.
- You can choose to have your handheld alert you when a new message arrives in your account. The beep or alert sound you hear is called a *notification*. Your handheld also notifies you of a new message's arrival by blinking an indicator light or vibrating if certain preferences are selected. For more information, see [“Making your handheld buzz or blink when you get new e-mail”](#) later in this chapter.

**NOTE** You must select the Notification option to have your handheld notify you when new messages are received. See the next section, [“Setting notification options,”](#) for more information.

- If auto get discovers and downloads new messages for an e-mail account, a notification appears on the Reminders screen, displaying the account name and the number of new messages. If auto get is scheduled for more than one account, a separate notification appears for each account. See [“Viewing and using the Reminders screen”](#) later in this chapter.

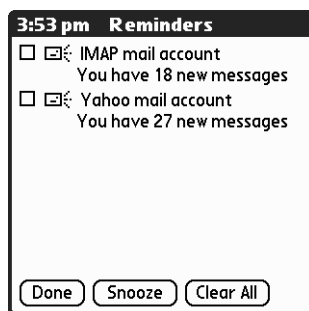

### Setting notification options

You can turn the notification sound on or off to notify you when new e-mail arrives. You can choose from a variety of sounds, such as birds, bumble bees, or simply an alarm.

To set notification options:

1. In the Inbox or on another folder screen, tap the Menu icon .
2. Tap Options.

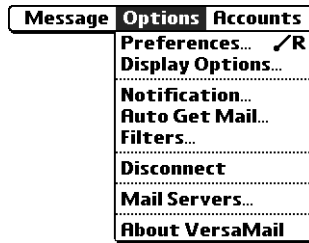

3. Tap Notification.
4. Tap the Notify me of new mail and mail alerts check box.



5. Tap the Notify Sound pick list and select a sound. The handheld plays a brief demonstration of the sound.

**NOTE** If you have installed a custom sound on your handheld, it appears on the Notify Sound pick list.

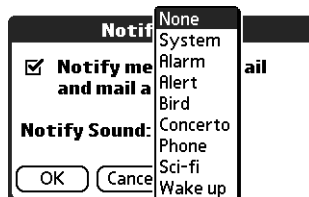



6. Tap OK.

You can follow these procedure steps to change the notification sound or to turn the sound on or off at any time.

### Making your handheld buzz or blink when you get new e-mail

In addition to setting a notification sound, you can also choose to have your handheld's indicator light blink or to have your handheld vibrate when you receive new e-mail. You select how your handheld notifies you of new e-mail in your handheld's General preferences.

#### To make your handheld buzz or blink when you get new e-mail:

1. Press Home .
2. Tap the Prefs icon .
3. Tap Sounds & Alerts.

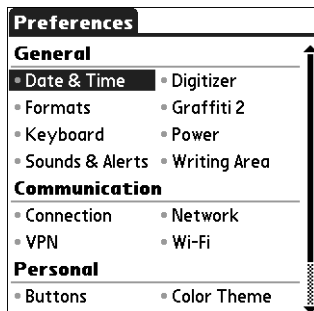

4. Do any of the following:
  - To change the volume of the Alarm Sound, tap the Alarm Sound pick list and select Low, Medium, High, or Off.
  - To change whether or not the handheld indicator light blinks when you receive new e-mail, tap the Alarm LED pick list and select On or Off.
  - To change whether or not the handheld vibrates when you receive new e-mail, tap the Alarm Vibrate pick list and select On or Off.

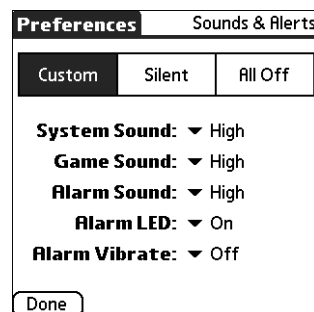

5. Depending on your handheld model, press the VersaMail button  or tap Done.



## Viewing and using the Reminders screen

Your handheld displays a Reminders screen that shows summary information about new e-mail messages and alerts from other applications, such as alerts to remind you of Date Book appointments.

To view the Reminders screen:

- Tap the blinking asterisk  in the upper-left corner of any screen.

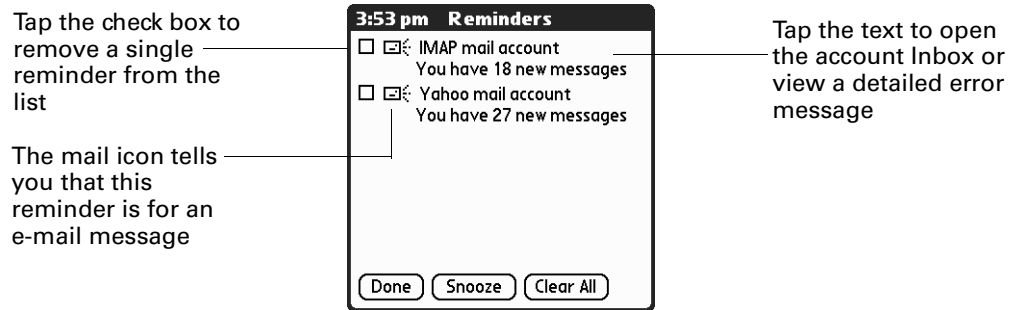

If you set up a scheduled auto get mail and you receive new e-mail messages, they are downloaded into the Inbox. As you work with e-mail messages in the Inbox, the Reminders screen doesn't display a reminder for any new messages that arrive, because the messages are already displayed in the Inbox.

**NOTE** A broken envelope icon  appears next to a message when an auto get mail or automatic send retry fails.

To respond to the reminders, do one of the following:

- Tap the check box to clear a reminder from the list.
- Tap the reminder (either the mail icon or the text description) to go to the Inbox of that account or to read a detailed error message.
- Tap Done to close the Reminders screen and return to whatever you were doing on your handheld before the Reminders screen appeared.
- Tap Clear All to dismiss all reminders on the Reminders screen.

When a notification appears on the Reminders screen, tap the notification to go to the Inbox of that account, or launch the VersaMail application and go to that account. Once you view a message in the Inbox it is removed from the Reminders screen, even if you do not open the message. Auto get then starts at the next scheduled interval, with the Reminders screen counter reset to 1.

If you do not view the Inbox of the selected account and another scheduled e-mail retrieval takes place and finds new messages, the Reminders screen adds the number of new messages to the notification for that account. For example, if scheduled auto get #1 finds two new messages and, before you view the Inbox, scheduled auto get #2 takes place and finds three more new messages, the Reminders screen notification indicates five new messages for that account.

If auto get discovers new messages but then fails for any reason, a notification appears on the Reminders screen, displaying the account name and an error message.

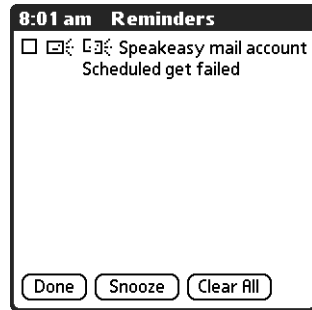

You can tap the error message or open the VersaMail application to that account for more detailed information on the failed auto get.

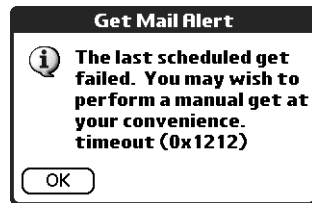

If auto get discovers no new messages for an account, no notifications appear on the Reminders screen for that account.

The Reminders screen displays only the most recent notification for an account. For example, if one scheduled auto get failed, but the next one succeeded and downloaded two new messages, the Reminders screen would first display the error message, but would display the number of messages retrieved after the successful retrieval.

Reminders screen notifications are specific for each account. For example, if auto get fails for one account but succeeds in downloading new messages for a separate account, the Reminders screen displays an error message for the first account and a message indicating the number of messages downloaded for the second account.

### Auto get mail retries

If the interval for a scheduled auto get is set at "Every 1 hour" or less frequently, and an auto get fails for any reason, the VersaMail application continues attempting to retrieve e-mail at 30-minute intervals until either the next scheduled auto get occurs or the end time for scheduled e-mail retrieval is reached. If the interval is set for more frequently than one hour and an auto get fails, the VersaMail application waits until the next scheduled auto get.

### Resource issues with auto get mail

If you use the auto get mail feature, you should be aware of the following potential resource constraints:

**Decreased battery life** If you set the auto get interval for more frequently than once per hour, you may drain your handheld's battery charge more quickly, and thus need to recharge the battery more frequently.

**Increased monthly charges** If your e-mail service provider charges a service fee, using the auto get feature can substantially add to your monthly charges. This issue is especially noticeable for POP accounts, because the size of the IDs used to locate POP account messages is much larger (and thus POP messages take longer to download) than for IMAP accounts.

**NOTE** If you primarily retrieve messages over your company's wireless LAN using the built-in 802.11b on your handheld, monthly charges should not be an issue.

If you set the auto get mail interval for more frequently than once per hour, an alert message appears.

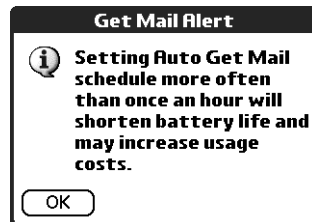

To minimize resource concerns, set your interval for e-mail auto get to no more frequently than once per hour.

### Inbox icons in the VersaMail application

The icons to the left of a message in the Inbox indicate the message's status.



Only the subject header information is downloaded.



Part or all of the message text is downloaded.



Part or all of the message text and attachment information is downloaded.

## Reading e-mail

To read e-mail, tap the e-mail message in the Inbox or the folder where the message is located.

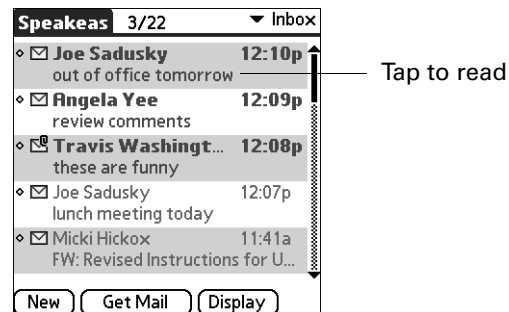

Alternately, you can use the navigator for one-hand message viewing.

### To read a message using the navigator:

1. Press Select on the navigator to highlight the first message displayed on the screen, and then press Up or Down to scroll one message at a time to the message you want to read.
2. Press Select to open the message.
3. After reading the message, press Select to close the message.

If you chose to get messages by subjects only, tap the More button  to view the body of the e-mail message, plus any attachments, up to the maximum message size you select. If the downloaded message exceeds your maximum message size, only a partial message is displayed. Tap the More button to view the entire message. See [“Getting e-mail by subject or getting the entire message”](#) earlier in this chapter.

If you chose to get entire messages, the body of the e-mail message is displayed. However, if the downloaded message exceeds your maximum message size, only a partial message is displayed. Tap the More button to view the entire message.

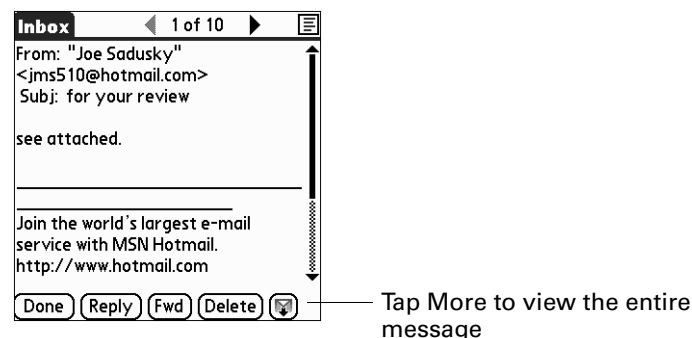

## Plain text and HTML e-mail

By default, the VersaMail application is set to receive mail in HTML format. This means that any e-mail messages sent as HTML will be displayed on your handheld with basic HTML formatting intact, including the following:

- Boldface
- Italics
- Underlining
- Colored words
- Bullet lists
- Numbered lists
- Line breaks

Most formatting not displayed is stripped of its HTML tags and shown as plain text. For certain types of graphic images (for example, JPEG or GIF files), the graphic may be displayed as a URL in the body of the e-mail message. In some cases, you can tap the URL to open the graphic image. See [“Working with URLs”](#) later in this chapter for more information.

When you set the VersaMail application to receive e-mail messages as HTML, any messages sent as plain text will be displayed as plain text only. You can also set the application to receive all messages as plain text only, regardless of the format in which they were sent. If you choose this option, only the text of any messages sent in HTML format will be displayed.

**NOTE** The VersaMail application sends all messages as plain text only, with all HTML tags stripped, even if you are forwarding or replying to a message that was originally received as HTML.

To select whether to receive e-mail messages in HTML or in plain text format:

1. Press Command  + R.

Alternately, press Function  + Menu , select Options, and then select Preferences.

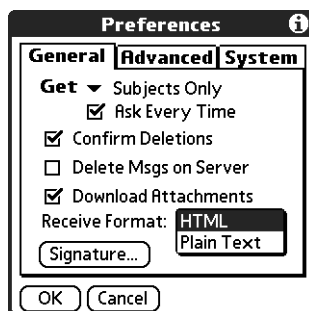

2. Tap the Receive Format pick list and select HTML or Plain Text. The default is HTML.
3. Tap OK.

### Viewing other folders

When you get new e-mail, it appears in the account's Inbox folder. You can move an e-mail message from one folder to another and then view it in the destination folder.

To view other folders:

1. Tap the folders pick list in the upper-right corner of the screen.

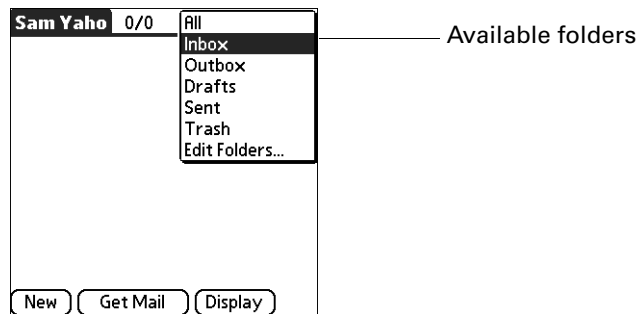

2. Tap the folder you want to view.

### Managing display options in the folder's list view

You can customize the way in which messages appear in the list view of your mail folders. The options you choose apply to all folders.

The display options that you can customize, and the default settings, are as follows:

Option	Default
Sort by	Date
Sort order	Descend
Summary view	Two-line view
Summary view columns	Sender, Date, Subject
Font	Gil Sans MT 12 Plain
Unread message color	Black
Read message color	Black

To change the sort order:

1. Tap Display.
2. Tap the Sort by pick list, and then tap the column name.

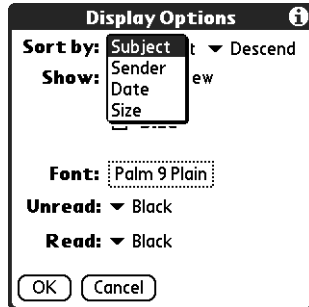

3. Tap Descend or Ascend to change the sort order.

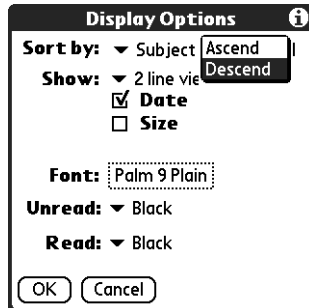

4. Tap OK.

To select a one-line or two-line view:

1. Tap Display.
2. Tap the Show pick list, and then tap the view you want.

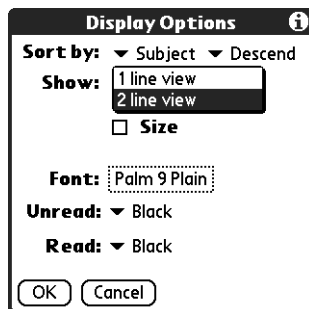

3. Tap OK.

**To display or hide a column in a folder's list view:**

1. Tap Display.
2. Tap the check box for each column that you want to show. The column options will change depending on whether you choose a one-line or a two-line view.

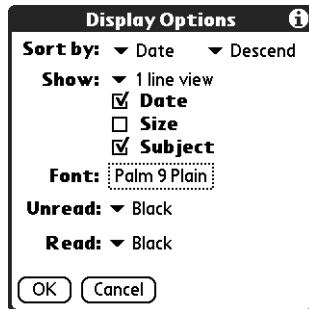

**NOTE** If you select Date, the Date column displays the message *time* for any messages received today—that is, any message received after 12:01 A.M. Otherwise, the Date column shows the date the message was received.

3. Tap OK.

**To change the font:**

1. Tap Display.
2. Tap in the Font field.

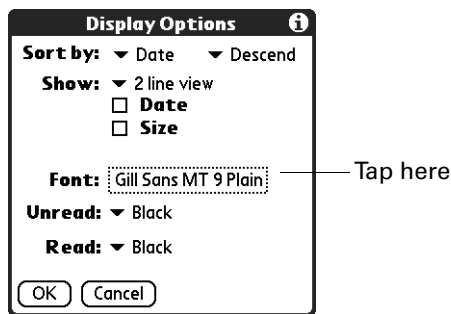

3. Tap the Font pick list and select the font you want.

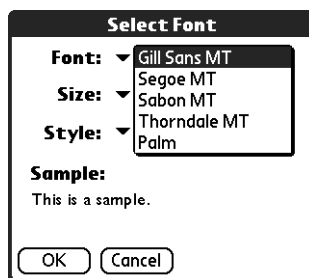



4. Tap the Size pick list and select the font size you want.

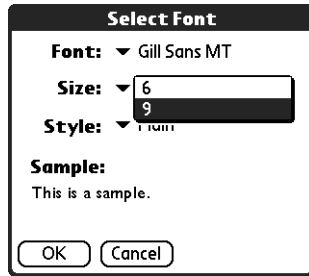

5. Tap the Style pick list and select the font style you want.

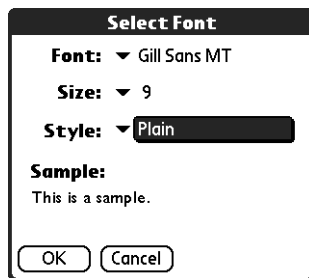

6. Tap OK.

To select colors for read and unread mail:

1. Tap Display.
2. Tap the Unread pick list, and then tap the color you want to use to display unread messages.
3. Tap the Read pick list, and then tap the color you want to use to display read messages.

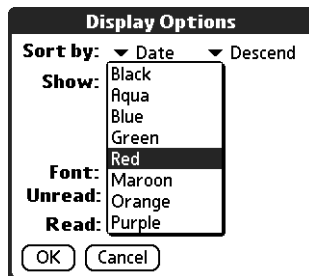

4. Tap OK.

In the list view itself, you can also change the size of the columns.

To change the size of a column in the folder's list view:

**NOTE** Changing column size is available for one-line message view only.

1. Tap and hold the stylus on the column divider.
2. Drag the column divider to change the width of the column.

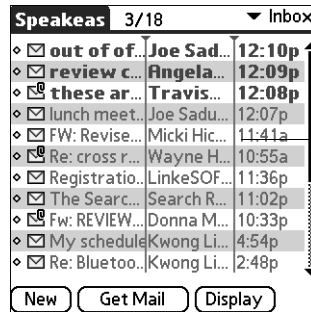

Drag the column divider left or right to make the column narrower or wider

3. Tap OK.

You can also change the font within an individual message. This change affects the the font of all messages you compose.

To change the font of a composed message:

1. On the message screen, tap the Menu icon .
2. Select Options.

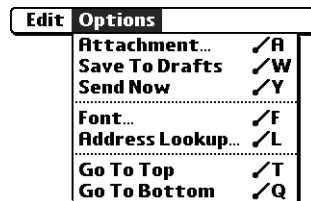

3. Tap Font.
4. Tap the Font pick list and select the font you want.

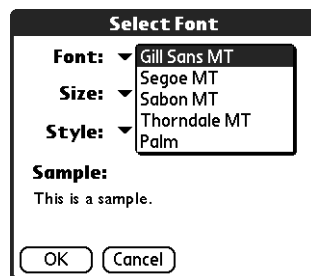

5. Tap the Size pick list and select the font size you want.

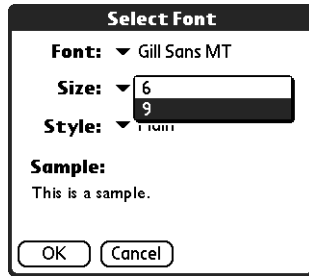

6. Tap the Style pick list and select the font style you want.

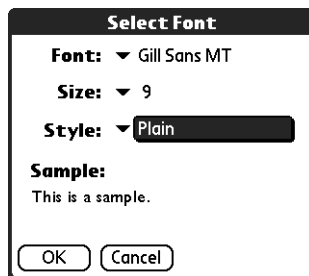

7. Tap OK.

### Moving e-mail between folders

You can move one or more e-mail messages between folders.

#### To move one e-mail message:

1. Tap the folders pick list in the upper-right corner of the screen, and then tap the folder name, or press Up or Down to move to the folder you want, and then press Select to select the folder.

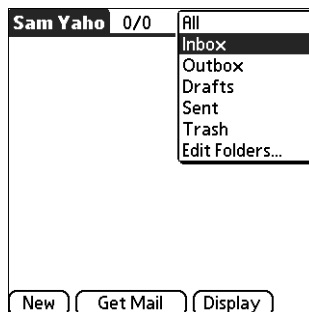

- Press Right on the navigator to open the Message menu, press Down to move to the Move To option, and then press Select to select this option.

Alternately, tap the icon to the left of the message, and then tap Move To from the pop-up menu.



The folders pick list appears.

- Press Up or Down on the navigator to move to the folder you want, and then press Select to select the folder.

Alternately, tap the folder you want.

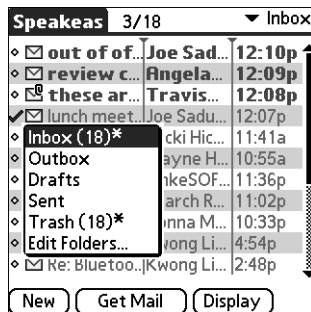

**TIP** You can also move a single e-mail message from within the body of the message by pressing Command (⌘), tapping the folder icon, and selecting the destination folder from the pick list. See [“Using the command bar”](#) later in this chapter for more information on the command bar.

**To move multiple e-mail messages:**

1. Tap the folder that contains the e-mail messages you want to move.
2. Select the messages by tapping to the left of each message icon.

**TIP** To select a group of adjacent messages, drag the stylus to the left of the message icons.

A checkmark appears next to each selected message.

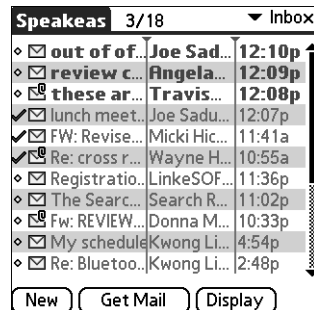

3. Do either of the following:

- Press Command (⌘) + V (alternately, press Function (fn) + Menu (⌘)), and then select Move To on the Message menu.
- Tap a message icon next to a selected message, and then tap Move To on the pick list.

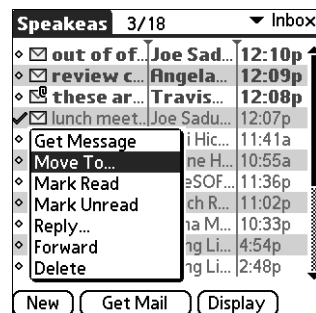

4. Tap the folders pick list, and select a destination folder.

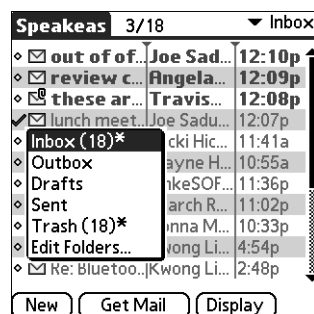

5. Tap OK, or press Function (fn) + Enter (↵).

## Creating and editing mail folders

You can also create new folders so that you can store e-mail messages by subject, person, or project. The VersaMail application has certain existing folders, such as Inbox, Outbox, Drafts, and Trash.

The procedure for creating and editing folders varies slightly between POP and IMAP e-mail accounts, as described in the following procedure.

### To create and edit e-mail folders:

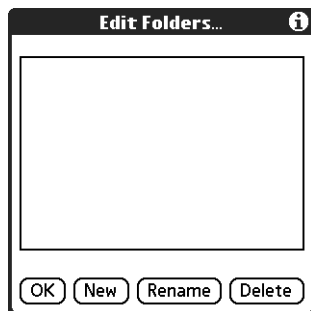

1. Tap the folders pick list in the upper-right corner of the screen, and then tap Edit Folders.
2. On the Edit Folders or Edit IMAP Folders screen, select any of the following:

POP accounts

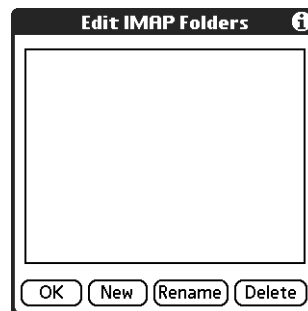

IMAP accounts



- To create a new folder, tap New, and then enter the new folder name. For IMAP accounts only, select the check box if you also want to create the folder on the server. When finished, tap OK, or press Function +  Enter .



POP accounts

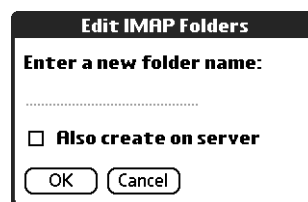

IMAP accounts



- To rename a folder, tap the folder name from the list on the screen, tap Rename, and then enter the new folder name. For IMAP accounts only, select



the check box if you also want to rename the folder on the server. When finished, tap OK, or press Function  + Enter .

#### POP accounts

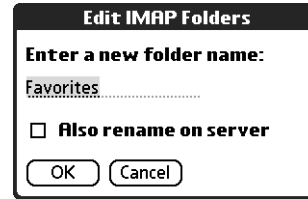

#### IMAP accounts



- To delete a folder, tap the folder name from the list on the screen, and then tap Delete. For IMAP accounts only, select the check box if you also want to delete the folder on the server, and then tap OK, or press Function  + Enter . For POP accounts, the folder will be deleted immediately and you will not see a confirmation screen.



Delete confirmation appears for IMAP accounts only

## Creating and sending new e-mail

When you create a new e-mail message, you can enter the person's e-mail address or use the Lookup screen to find a particular address.

To create a new e-mail message:

1. Tap New, or press Command  + N.

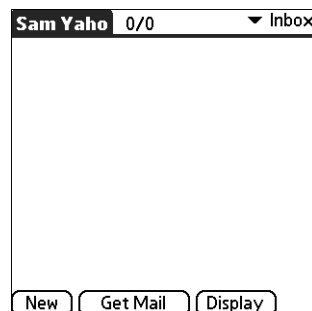

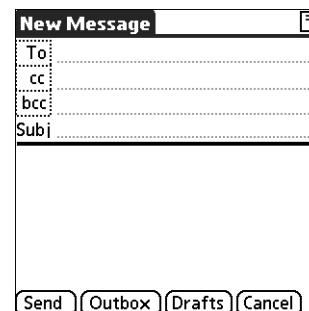

2. Enter the recipient's name using one of the methods described in the next procedures.

**NOTE** When you address a message to several recipients, you do not see all the recipients on the To list because the list is truncated on the To line. If you tap the To field, a dialog box shows all recipients for the current message.

### Addressing a message by typing the address

You can address a message by entering the complete address.

#### To enter the address:

1. On the New Message screen, tap or navigate to the To field and enter the address, and then tap Done.



For multiple recipients, type a semicolon (;) and then a space between recipient names, or press Enter (⏎). The To field expands to two lines during address entry for addresses longer than the one-line display.

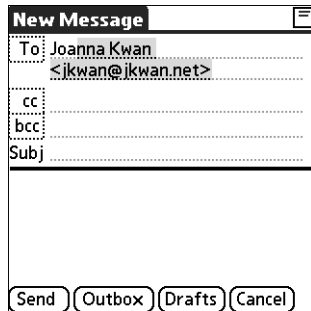

After address entry, addresses longer than one line are shown on a single line with an ellipsis symbol to the right of the address line.

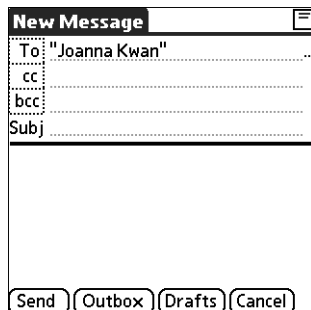

Ellipsis indicates address is longer than one line



Alternately, on the New Message screen, tap To and enter the address on the Recipient List screen, and then tap Done. Use the shortcut buttons at the bottom of the screen for quick address entry.

For multiple recipients, type a semicolon (;) or tap the semicolon button at the bottom of the screen, and then type a space between recipient names.

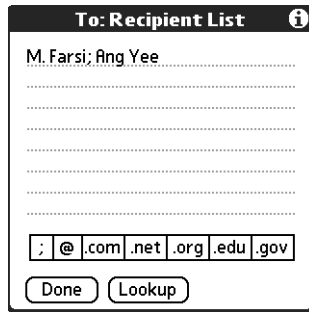

**NOTE** If you enter a comma instead of a semicolon, it is automatically changed to a semicolon. If you enter a space with no punctuation between names, semicolons are not inserted and the e-mail message is improperly addressed.

If you want to edit an e-mail address that is longer than the line provided on the New Message screen, tap the To field and edit the address.

2. To send copies, tap cc: or bcc: and enter the recipient's address.

Copies (cc:) allow recipients to see the addresses of the other recipients, but addresses in the blind copies (bcc:) field are hidden from all other recipients.

**TIP** To automatically fill in the address as you type, see [“Using Smart Addressing to address a message”](#) later in this chapter.

### Addressing a message using Address Book

You can enter a recipient's address by using the Lookup screen to select the address. The names and addresses on the Lookup screen come from Address Book.

#### To use an address from Address Book:

1. On the New Message screen, tap the word To.
2. On the Recipient List screen, tap Lookup.

3. On the Address Lookup screen, tap the address you want, and then tap Add.

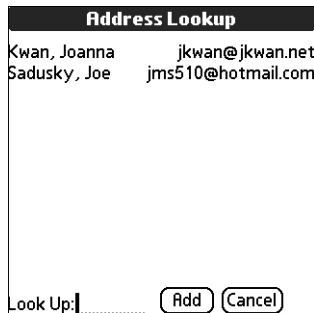

4. (Optional) Repeat steps 2 and 3 for each address you want to add.
5. To enter an address in the cc: or bcc: field, tap the field name and follow the steps given for the To field.

### Using Smart Addressing to address a message

Smart Addressing types ahead and completes a recognized e-mail address. Smart Addressing automatically fills in fields when the recipient's name and e-mail address are in your Address Book.

By default, Smart Addressing is selected in VersaMail Preferences.

#### To use Smart Addressing to address a message:

1. On the New Message screen, tap in the To field.
2. Start entering the person's name, such as Joe Smith.

Once the name is recognized from your Address Book, the name and e-mail address are automatically completed on the recipient list. For example, if you have a Joe Smith and a Joan Smith in your Address Book (and no other names starting with J), once you type "Joe," the entry "Joe Smith" is completed with the correct e-mail address.

3. If Smart Addressing recognizes more than one name for the typed entry, or if the recognized name has more than one e-mail address associated with it, all of the names or e-mail addresses are displayed. Navigate or tap to select the name/e-mail address you want.

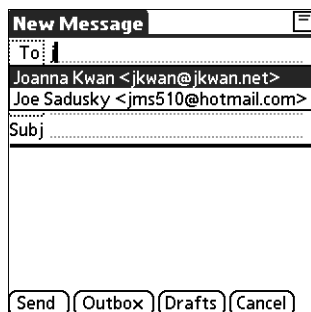



4. Tap Done.

## Turning Smart Addressing on or off

You can turn Smart Addressing on or off in VersaMail Preferences. By default, Smart Addressing is turned on.



To turn Smart Addressing on or off in VersaMail Preferences:

1. In the Inbox, press Command  + R.

Alternately, in the Inbox, press Function  + Menu , tap Options, and then tap Preferences.

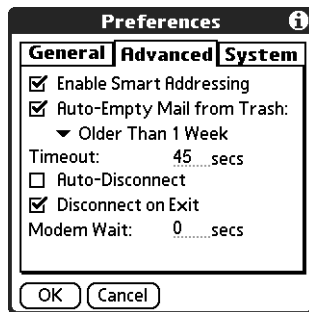
2. Tap Advanced.



3. Tap the Enable Smart Addressing check box if it is not selected. A checkmark means it is turned on.
4. Tap OK, or press Function  + Enter .

## Composing and sending e-mail

After you enter your recipient addresses, you can compose the rest of the e-mail message.

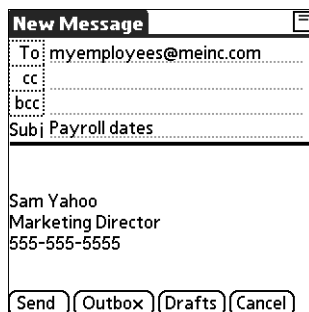

To compose the rest of the e-mail and send it:

1. Tap the Subject field and enter the subject of your e-mail.



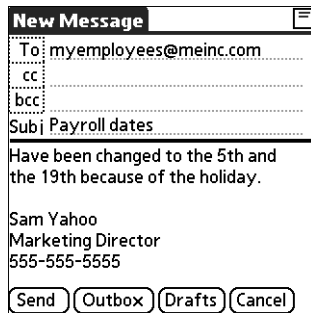

2. Tap the area below the Subject line and enter the text of your e-mail.



To access the editing features available on the Edit menu, press Function  + Menu . The first character of each sentence is automatically capitalized for you.

3. (Optional) Tap the Options menu and select Add Attachments (alternately, press Command  + A). See [“Attaching files from a handheld application”](#) later in this chapter.
4. Tap one of the following to send the e-mail:

- Send** Sends the e-mail immediately. (Alternately, press Command  + Y.)
- Outbox** Stores e-mail in the Outbox so you can compose e-mail offline and then send all e-mail during one connection with the server. To send your e-mail later, tap Get & Send. A connection is made to the mail server and all the e-mail in the Outbox is delivered.

**TIP** You can also tap Drafts (or press Command  + W) to save this message in the Drafts folder rather than send it.

### Send retry

When you tap Send on the message menu, the VersaMail application automatically attempts to send the message. If the send attempt fails for any reason (for example, your handheld is out of range, or the application cannot connect to the mail server), you can choose to have the application move the message to the Outbox and continue to try to send the message at 30-minute intervals, a maximum of three times.

If you put a message in the Outbox, you must perform a manual send to send the message on the first attempt. The VersaMail application attempts automatic send retry only after a manual send attempt fails.

If automatic send retry succeeds on any attempt, the message is moved to the Sent folder.

**NOTE** Automatic send retry occurs only if you tap Send to send the message manually. It does not work if you tap Get & Send.

To select automatic send retry:

- Tap Yes on the dialog box notifying you that manual send has failed.



**NOTE** Automatic send retry is not supported for VPN or SSL connections, or for accounts for which your ISP requires you to log in to the mail server before sending mail. It is also not supported if you have configured the security preferences on your handheld to encrypt databases on the handheld.

### Send retry notifications

If automatic send retry fails after the third attempt, a notification appears on the Reminders screen. A separate notification appears for each e-mail account for which a send retry has failed.

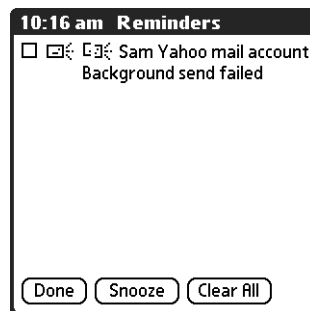

Tap the notification or open the account in the VersaMail application to view a detailed error message.



Viewing the error message deletes the notification from the Reminders screen. The Reminders screen shows only the most recent notification for an e-mail account, no matter how many automatic send retries have been attempted for that account.

If automatic send retry fails after the third attempt, you must send the message manually.

**NOTE** If you perform a soft reset or a HotSync operation during automatic send retry, the retry cancels. You must manually send any messages in the Outbox after the soft reset.

### Modifying messages in the Outbox

A message in the Outbox waiting for the next automatic send retry can be edited, moved, or deleted. However, if you edit the message, you will need to perform a manual send in order to send the message. If the manual send fails, you can choose to store the message in the Outbox to await the next automatic send retry.

During automatic send retry, any message that the VersaMail application is attempting to send is in a locked state and cannot be edited, moved, or deleted. If you try to modify a message in the locked state, an error message appears.



If a send retry fails after the third attempt, the message is stored in the Outbox in the error state. You can send the message again manually, or edit, move, or delete the message. However, if you edit the message, you will need to perform a manual send in order to send the message. If the manual send fails, you can choose to store the message in the Outbox to await the next automatic send retry.

See the next section [“Outbox icons in the VersaMail applications,”](#) for icons that indicate messages awaiting the next automatic send retry as well as messages in the locked and error state.

### Outbox icons in the VersaMail applications

The icons to the left of a message in the Outbox indicate the message’s status.



Message is waiting either to be manually sent or to be sent during the next send retry. You can edit, move, or delete a message in this state.



Send retry is currently in process; you cannot edit, move, or delete a message in this state.



Third automatic send retry has failed. You must manually send a message in this state.

### Completing drafts

If you are composing an e-mail message and you exit the VersaMail application before tapping Outbox, Send, or Cancel, the e-mail automatically moves to the Drafts folder. To finish editing the e-mail, tap the folders pick list and select Drafts. Select the e-mail you want to complete or edit, and tap Edit. You can also delete the e-mail in the Drafts folder.

## Attaching a personal signature

You can include a personal signature, such as your name, e-mail address, and telephone number, with each e-mail you send.

To create a personal signature:

1. Press Command  + R.

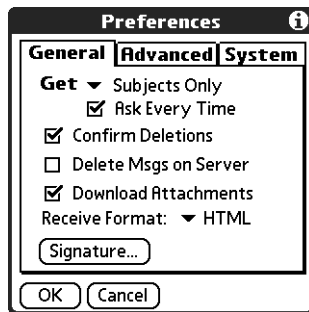

Alternately, press Function  + Menu , tap Options, and then tap Preferences.

2. Tap Signature.



3. Tap the Attach Signature check box to select it.



4. Enter your signature information.
5. Tap OK, or press Function  + Enter .

## Forwarding e-mail

You can quickly forward e-mail messages from any folder other than the Outbox folder.

To forward e-mail:

1. Tap the folders pick list and select the folder that contains the e-mail.
2. Tap the e-mail message to display it.

3. Press Command  + F.

Alternately, tap the Forward button.

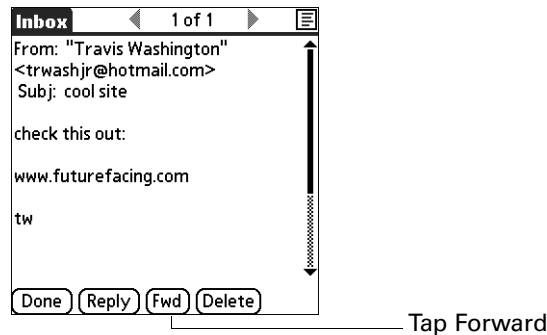

4. Tap the word To.
5. On the Recipient List screen, enter or look up the recipient address. See the procedure for creating new e-mail earlier in this chapter for more information on addressing messages.

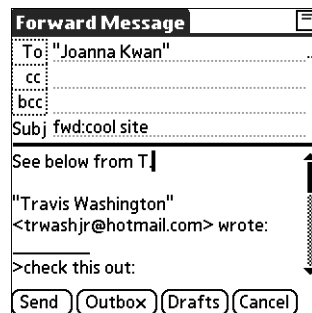

6. (Optional) Enter some text describing the forwarded message.
7. Tap Send (alternately, press Command  + Y) to send the message, or tap Outbox to store it in the Outbox.

**NOTE** Forwarded messages are always sent as text only, even if you received the original message in HTML format.



## Replying to e-mail

You can reply to an e-mail message as you are reading it, or start the reply when viewing messages in the folders list view.



To reply to an e-mail message that you are reading:

1. Tap the message you want to reply to.
2. Tap Reply, or press Command  + O.

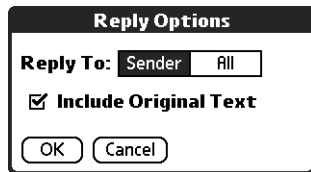

3. In the Reply Options dialog box, select options for replying to the sender only or to all e-mail recipients, and for including original message text.



4. Tap OK, or press Function  + Enter .
5. Enter a reply.

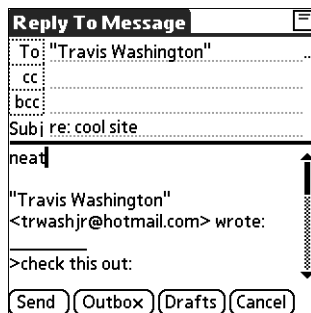

6. Tap Send (alternately, press Command  + Y) to send the message now, or tap Outbox to send it later.

**NOTE** Replies are always sent as text only, even if you received the original message in HTML format.

**To reply to an e-mail message from the folders list:**

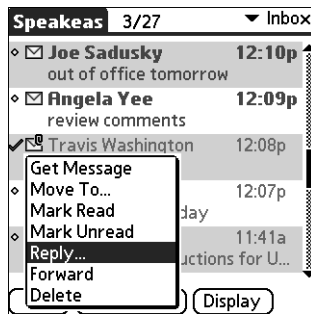

1. On the message screen, tap the folder name in the upper-left corner to open the message menu, and then press Right on the navigator to move to and open the Options menu.
2. Press Down on the navigator to move to the Reply option, and then press Select to select this option.

**TIP** Alternately, you can tap the folders pick list, select the folder that contains the e-mail, tap the envelope icon next to the message, and then tap Reply on the pick list.

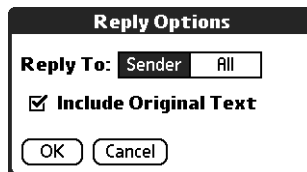

3. In the Reply Options dialog box, select options for replying to the sender only or to all e-mail recipients, and for including original message text.



4. Tap OK, or press Function  + Enter .
5. Enter a reply.

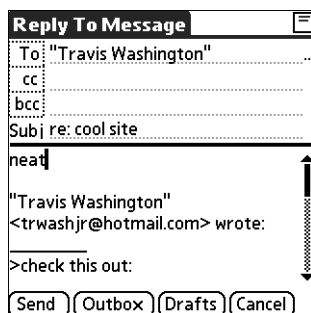

6. Tap Send (alternately, press Command  + Y) to send the message now, or tap Outbox to send it later.

**NOTE** Replies are always sent as text only, even if you received the original message in HTML format.

## Working with URLs

You can tap a URL in a received message to view the web page or file associated with the URL. Tapping the URL opens PalmSource® Web Browser to view the page or file.

You can also tap an embedded e-mail address to open a new message screen with the address in the To field.

Depending on whether the received message is displayed in HTML or plain text format, URLs and e-mail addresses appear in slightly different forms, as follows:

**HTML** URLs and e-mail addresses appear as blue underlined text.

**Plain text** URLs appear as any text beginning with “http://” or “www.” You cannot view the page or file associated with a URL that does not begin with “http://” or “www” in a plain text message.

E-mail addresses appear in the form “username@mailservice.com” (or other three-letter extension such as .net, .org, and so on).

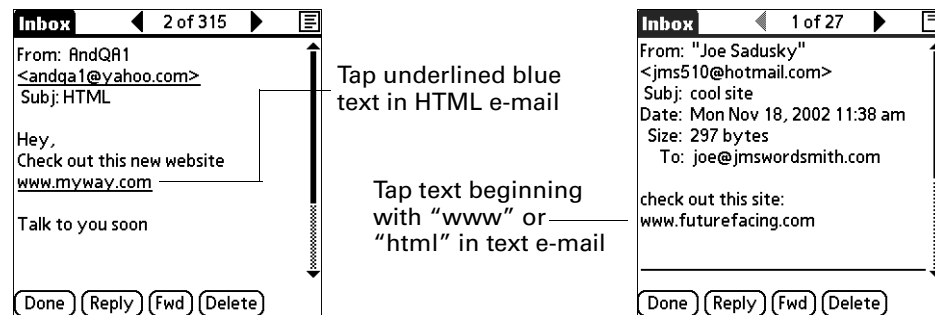

## Working with attachments

You can easily download, view, and send attachments with e-mail messages.

### Downloading attachments to your handheld

At times e-mail contains attached files, such as Microsoft Word or text files, that you want to view or install on your handheld. You can download and work with the following attached files:

- vCard (.vcf)** This is an address.
- vCal (.vcs)** This is usually a calendar appointment or a To Do task.
- Text (.txt)** This is usually a memo or another plain text file.

<b>HTML (.html or .htm)</b>	Usually a web page or a formatted text file. Your handheld displays HTML attachments with full formatting intact in Web Browser.
<b>Microsoft Word (.doc)</b>	The formatting is stripped and the text of most Microsoft Word documents is shown.
<b>JPEG (.jpg), bitmap (.bmp), and TIFF (.tif) files</b>	These are graphics files. You can download these files and view them using the Photo Viewer application on your handheld.
<b>Other application files</b>	For other types of application files, your handheld may contain a viewer that allows other applications to pass it a file for viewing. For example, your handheld may contain an image viewer that allows another application to pass it a GIF attachment for viewing. You do not need to do anything different in the steps for downloading and viewing attachments; if your handheld contains such a viewer, the attachment is automatically opened. If your handheld does not contain such a viewer, you cannot view the attachment. Among the file types that may be supported are GIF, MP3, and AAC files.
<b>PRC (.prc)</b>	This is a Palm OS® application that you can install and run on your handheld.
<b>PDB (.pdb)</b>	This is a file that works with specific Palm OS applications.

Among the types of attachments you can receive are the following handheld application files:

- Address Book entries
- Date Book appointments
- To Do list items
- Text memos

You can also save downloaded files to an expansion card. See [“Saving attachments to an expansion card”](#) later in this chapter for information.

**NOTE** The maximum message size that you can retrieve is 60KB for the body text and 2MB total, including attachments. If the attachment is too large, it cannot be downloaded to the handheld.

**To download an attachment:**

1. In the Inbox, tap the message with the attachment.

A paper clip icon appears on the message's icon if the message has an attachment that has been downloaded.

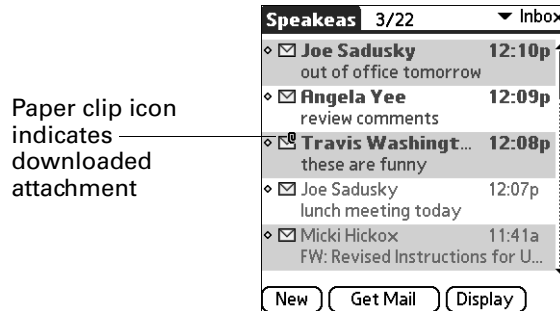

If you choose to get messages by subject only, you must tap More for each downloaded message in order to view the body of the e-mail message plus any attachments, up to the maximum message size. If the downloaded message (either body text alone or body text plus any attachments) exceeds your maximum message size, you see a message showing that the message and/or attachments were too large and asking if you would like to continue downloading them.

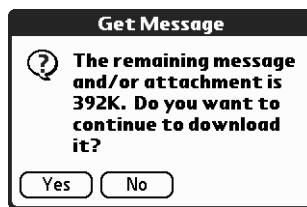

For example, if the maximum message size is 5KB and you download a body of 2KB, then any attachment under 3KB is also downloaded, and any attachment over 3KB is not. See [“Downloading large attachments”](#) later in this chapter.

2. Click the red paper clip icon in the upper-right corner. If the attachment is not downloaded, a paper clip icon will not appear even though the message was sent with an attachment. You must download the attachment for the paper clip icon to appear.

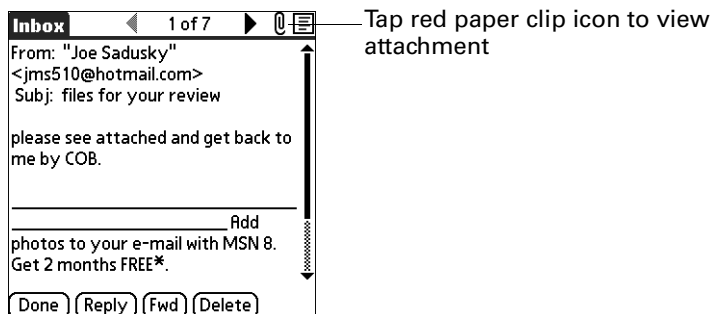

- Your options for working with a downloaded attachment vary according to the file type.

Type	Action
Viewable file: text, Word doc, To Do task, HTML, graphic, and so on	Tap the name of the attachment you want to view, and then tap View. If there are multiple viewers registered on your handheld for the attachment file type, either use the default viewer shown, or select a viewer from the list. For example, if you have two photo viewing applications on your handheld and you select a photo attachment on the list, the Viewer pick list appears containing the names of the photo viewing applications. Tap the pick list and select the application you want to use to view the photo attachment. If there is only one viewer registered for the attachment file type, the viewer is shown without a list.
Palm OS application or database file (.prc or .pdb)	Tap the name of the attachment you want, and then tap Install. The file is installed automatically.

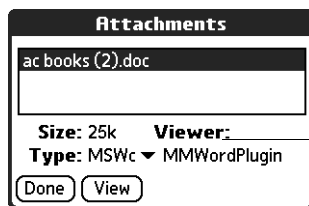

Viewer pick list is displayed only if handheld has multiple viewers registered for attachment file type

Button displays View or Install, depending on the attachment file type

- When you have finished viewing or installing the attachment, tap Done. This returns you to the Attachments dialog box, where you can select another attachment if you want to.

If there is no Done button on the attachment screen, press the VersaMail button  to return to the Inbox of the account you were in.

- When you have finished viewing or installing all attachments, tap Done on the Attachments dialog box. This returns you to the Message screen.

### Downloading large attachments

Downloading and viewing a message with a single attachment that exceeds your maximum message size, or a message with multiple attachments whose total size exceeds your maximum message size, requires some extra steps.

To determine if a message has an attachment or multiple attachments that exceed the maximum message size:

- In the Inbox, tap the message title.



More button indicates that message plus any attachments exceeds maximum message size

If the message plus attachments exceeds the maximum message size, the More button  appears on the Message screen. In the case of multiple attachments, if some of the attachments were downloaded completely, you see both the red paper clip icon (indicating fully downloaded attachments) and the More button (indicating incompletely downloaded attachments).

To download a single attachment that exceeds the maximum message size:

1. Tap the More button.



Tap More

2. Tap No to stop downloading and return to the Message screen.  
Tap Yes to continue downloading the entire message with attachment.

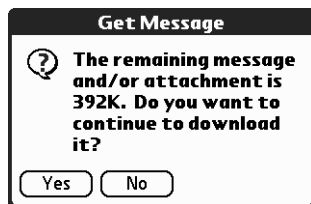

3. (Optional) Tap Cancel to stop downloading and return to the Message screen.

When downloading is complete, the red paper clip icon appears and the More button is no longer displayed. Follow the procedure for viewing an attachment presented earlier in this chapter.

To download multiple attachments whose total size exceeds the maximum message size:

1. Tap the red paper clip icon.

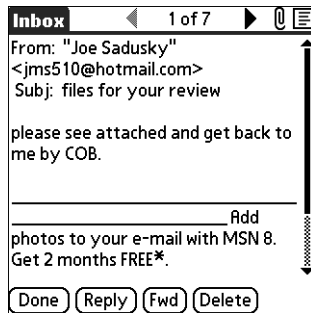

2. Select one of the following:

- To return to the Message screen, tap Cancel.
- To view any fully downloaded attachments without continuing to download additional attachments, tap No. Follow the procedure for viewing an attachment presented earlier in this chapter.
- To continue downloading all messages, tap Yes.

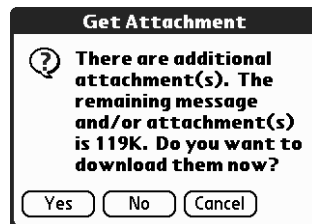

3. (Optional) Tap Cancel to stop downloading and return to the Message screen.

When downloading is complete, the Attachments dialog box appears, showing all downloaded messages. Follow the procedure for viewing an attachment presented earlier in this chapter.

### Saving attachments to an expansion card

If you have purchased an expansion card that provides extra memory, you can save downloaded attachments to the expansion card.

To save an attachment to an expansion card:

1. Insert the expansion card into the slot on your handheld.
2. Follow the procedure for downloading attachments described earlier in this chapter.



3. On the Attachments screen, tap Save To Card.

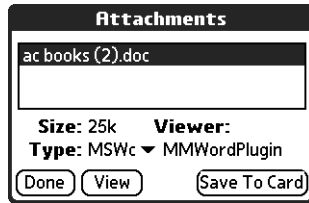

4. Tap OK.

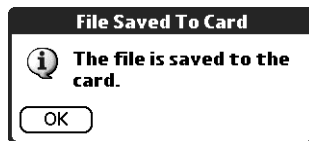

### Attaching files from a handheld application

You can attach files on your handheld to e-mail messages you send. For example, you can attach files from the various handheld applications, such as any Date Book appointment (.vcs), To Do List tasks (.vcs), or text memos (.txt).

**NOTE** The maximum size message you can send is 60KB for the body text and 2MB total, including attachments. The maximum number of attachments for any e-mail message is ten, regardless of the attachments' total size.

You can attach the following types of files from a handheld application:

- vCard (.vcf)
- vCal (.vcs)
- Memo/Text (.txt)
- PRC (.prc)
- PDB (.pdb)

To attach a file from a handheld application:

1. Press Command  + A.

Alternately, press Function  + Menu , tap Options, and then tap Attachment.

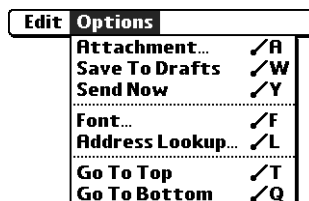

2. Tap the Type pick list and select the file type.

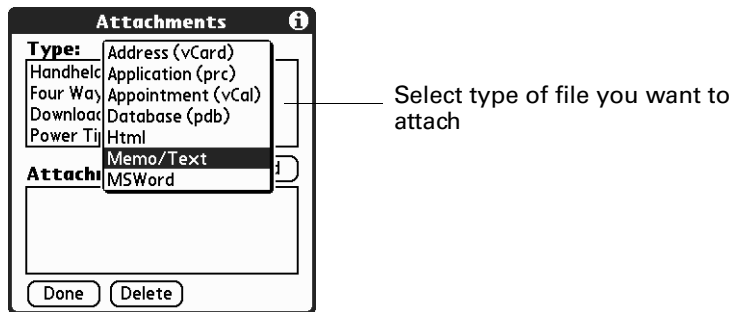

All files of the selected type appear in the Type box. For example, if you select Appointments (vCal), tap Date Book to see a list of appointments from a particular date that you can attach, or tap To Do to see To Do List tasks.

3. Tap the file that you want to attach, and then tap Add.

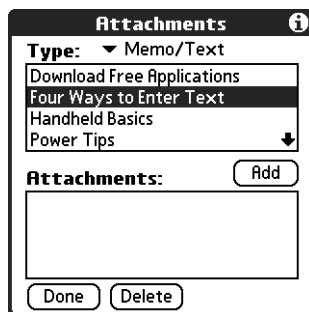

The selected file appears in the Attachments box.

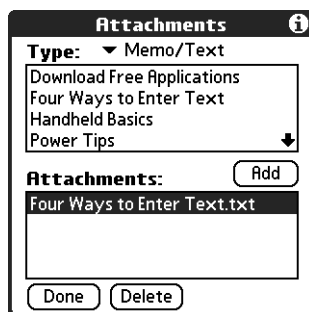

4. Repeat steps 2 and 3 for each attachment you want to add, and then tap Done.

**TIP** To delete an attachment from an e-mail message, tap the attached file in the Attachments box and then tap Delete.

5. Tap Send or Outbox.

### Attaching files from an expansion card

If you have purchased an expansion card and have saved files to the card, you can attach files from the card to an e-mail message you are sending. The types of files you can attach from an expansion card include the following:

- Word docs
- HTML files
- JPEG and GIF graphics files
- MP3 and WAV audio files
- Any other file type

#### To attach a file from an expansion card:

1. Insert the expansion card into the slot on your handheld.
2. On the New Message screen, tap the Menu icon .
3. Tap Options.
4. Tap Add Attachment.

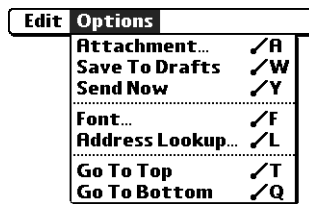

5. Tap the From pick list and select Files on Card.

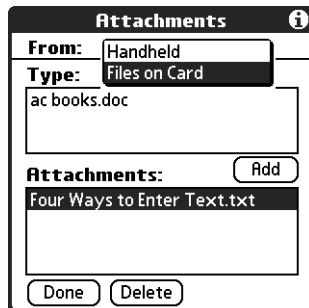

6. Tap the Type pick list and select the file type.

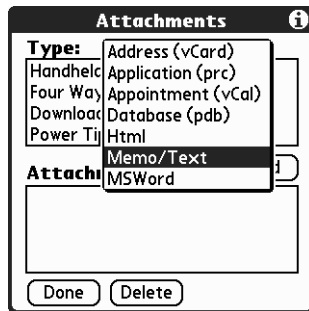

Only file types that correspond to the types of files on the card will be displayed on the list. For example, if the card contains only Word docs and Address Book entries, only the file types “doc” and “vCard” will be listed. You can select a particular file type, or select All Files to view all files on the card.

7. Tap the file that you want to attach, and then tap Add.

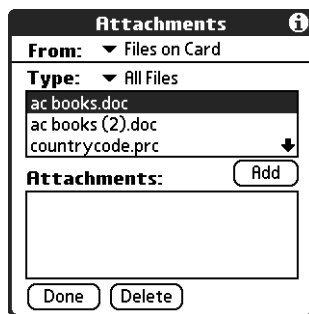

The selected file appears in the Attachments box.

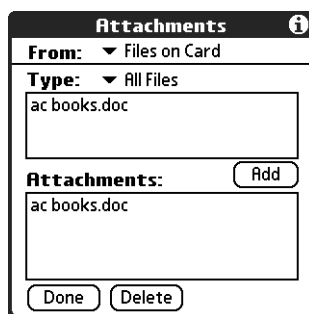

8. Repeat steps 6 and 7 for each attachment you want to add, and then tap Done.

**TIP** To delete an attachment from an e-mail message, tap the attached file in the Attachments box and then tap Delete.

9. Tap Send or Outbox.

### Forwarding an attachment

You can include an attachment on any message you forward, up to the maximum message size.

#### To forward a message with an attachment:

1. Tap the folders pick list and select the folder that contains the e-mail.
2. Tap the e-mail message to display it.
3. Tap the Forward button, or press Command  + F.
4. Tap the word To. On the Recipient List screen, enter or look up the recipient address. See the procedure for creating e-mail earlier in this chapter for more information on addressing messages.
5. Follow the procedure for attaching files presented earlier in this chapter.

## Deleting messages

You can delete one or more e-mail messages from any folder. For example, you can delete old messages in the Inbox or messages that you were working on in the Drafts folder. When you delete a message, it is placed in the Trash folder. See [“Emptying the trash”](#) later in this chapter.



To delete messages on the server when you empty the trash on your handheld, you can select the Delete Msgs on Server setting in VersaMail Preferences. If you don't periodically empty the trash and delete messages on the server, any incoming e-mail may “bounce” back to the sender. See [“Setting preferences for getting and deleting e-mail”](#) later in this chapter.

#### To delete one or more messages:



1. Tap the folders pick list and select the folder that contains the message you want to delete.
2. Do one of the following:

Item to delete	Action
One message	Tap the bullet next to the message's icon.
Multiple messages	Tap the bullet next to the icon of each message that you want to delete.
A group of adjacent messages	Drag the stylus along the left of the message icons. To select another group, lift the stylus and select the next group of messages.

3. Press Right on the navigator to move to and open the Message menu.
4. Press Down on the navigator to move to the Delete option, and then press Select to delete the message.

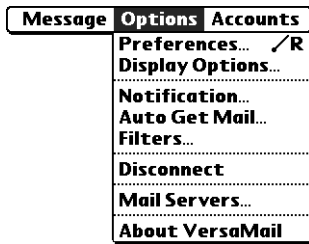
**TIP** Alternately, you can tap the message icon next to a selected e-mail message and then tap Delete, or press Function  + Menu  and then select Delete.



5. Tap OK, or press Function  + Enter .
6. (Optional) Tap Also delete message(s) on server if you want to delete the message from the server now.

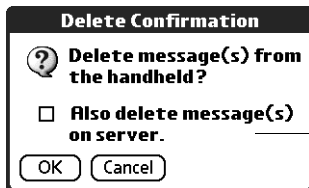

If you selected the setting Delete Msgs on Server in VersaMail Preferences, this check box is selected



The selected messages move to the Trash folder and are deleted from your handheld when you empty the trash. If you set the preference to automatically empty the trash, the messages are deleted when the trash is emptied. By default, the trash auto-empties all deleted e-mail older than one week. See [“Emptying the trash”](#) later in this chapter for more information.

---

**IMPORTANT** If you delete a message on the server, you cannot retrieve it and view it again later.

---

**To delete messages before a certain date:**

1. Press press Function  + Menu , and then tap Delete Old from the Message menu.



2. Tap the Folder pick list and select the folder that contains the messages you want to delete.



Displays the current folder for deleting messages

3. Tap the Older than pick list, and then tap One Week, One Month, or Choose Date.



If you tap Choose Date, you can select a date from the calendar.

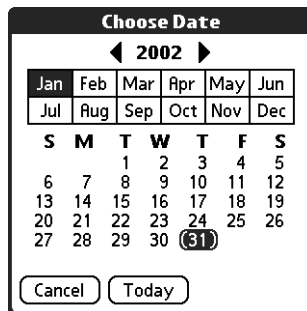

Tap a date to select it, or tap Today

4. Tap Delete.
5. (Optional) Tap Also delete message(s) on server if you want to delete the message from the server now.





6. Tap OK, or press Function  + Enter .

## Emptying the trash

Deleted e-mail accumulates in the Trash folder and takes up space on your handheld. To increase memory, you should empty the trash regularly. If you want to automatically empty the trash, you can set a preference to empty the trash immediately or empty any e-mail older than a certain number of days.

### To empty the trash:

1. Press Command  + E.

Alternately, press Function  + Menu , and then select Empty Trash from the Message menu.



**NOTE** If Auto-Empty Mail from Trash is selected in VersaMail Preferences, a message asks if you want to delete the trash.

2. (Optional) Tap Details to see how many messages are in the trash and whether the messages are set to be deleted on the server.



3. If you want to delete messages from the handheld as well as from the server, tap Both. A message asks if you want to update the server now.



To delete the message from only the handheld now, tap Handheld.

**NOTE** Many e-mail providers, such as Yahoo, have size restrictions for mail storage. If your mailbox on the server becomes full, messages are returned to the senders.



**To have the trash emptied automatically:**



1. Press Command  + R.

Alternately, press Function  + Menu , select Options, and then select Preferences.

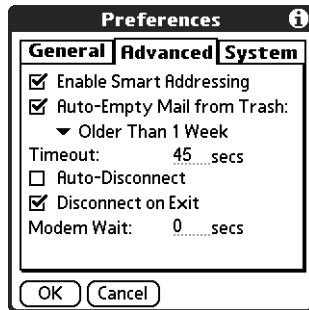
2. Tap Advanced.



By default, Auto-Empty Mail from Trash is selected, and the time interval is set at Older Than 1 Week.

3. Tap the pick list, and select how often you want the e-mail messages automatically emptied from the trash.
  - Immediately.
  - Older Than 1 Day.
  - Older Than 3 Days.
  - Older Than 1 Week.
  - Older Than 1 Month.
4. Tap OK, or press Function  + Enter .

## Marking messages as read or unread



You can mark messages as read or unread. When you tap a message to read it, it is automatically marked as read.

**To mark messages as read or unread:**

1. Tap the folders pick list and select the folder you want.
2. Tap the icon next to the message you want to mark.

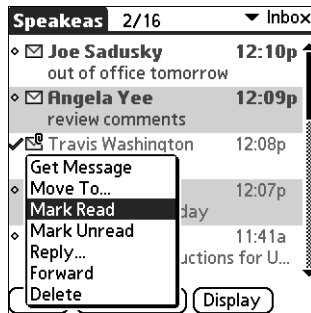
3. Tap Mark Read or tap Mark Unread.



**TIP** To mark multiple messages, tap the bullets next to the messages you want, press Function  + Menu , and then select Mark Read or Mark Unread.

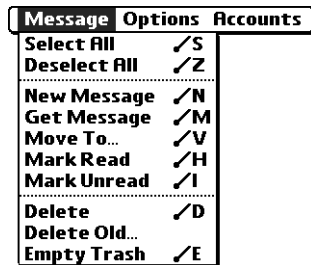

4. For IMAP accounts only: Tap Handheld to mark the messages as read or unread on your handheld. Tap Both to mark the messages on both the handheld and the server.



If you tap Both, this message appears.



Tap OK to connect with the server and immediately mark the messages as read or unread on the server. This action also processes any other pending actions on the server, such as messages not yet deleted.

Tap Cancel if you want the messages marked during the next HotSync operation or the next time you connect to the server.

**NOTE** Because POP servers do not support the read or unread message feature, the message is in bold or regular typeface for POP accounts on the handheld, but you can't connect with the server to change the message state.



Read messages appear in plain text; unread messages appear in bold text.

## Setting preferences for getting and deleting e-mail

VersaMail Preferences determine how the VersaMail application gets, sends, and deletes e-mail.

To set e-mail preferences:

1. Press Command  + R.

Alternately, press Function  + Menu , select Options, and then select Preferences.

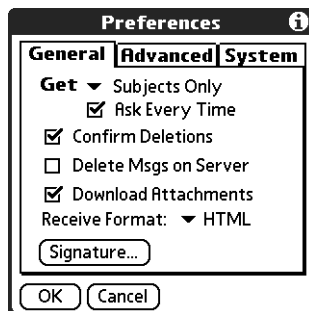

2. Select preferences:



<b>Get</b>	Enables you to retrieve the subject only or the entire message.
<b>Ask Every Time</b>	Displays a dialog box for choosing subjects only or entire messages each time you retrieve e-mail. If deselected, messages are retrieved according to the option you select in the Get pick list.
<b>Confirm Deletions</b>	Displays a confirmation dialog before deleting e-mail.
<b>Delete Msgs on Server</b>	If selected, automatically deletes messages on the server that you have deleted on your handheld. If not selected, you will be asked each time you delete messages on your handheld whether you want to also delete them on the server. Because mailboxes on the server usually have size restrictions, we recommend periodically deleting messages on the server.

<b>Download Attachments</b>	Causes files attached to e-mail to be automatically downloaded to your handheld. Attachments that exceed the maximum message size cannot be downloaded. See <a href="#">“Working with attachments”</a> earlier in this chapter for more information.
<b>Receive Format</b>	Enables you to retrieve messages in HTML format or in plain text format. If you choose HTML, any messages sent to you in HTML format will be displayed with basic HTML formatting intact. Other messages will be displayed as plain text. If you choose Plain Text, all messages will be displayed as plain text, regardless of the format in which they were sent. Default setting is HTML.  See <a href="#">“Working with URLs”</a> earlier in this chapter for more information on receiving e-mail in HTML format.
<b>Signature</b>	Enables you to attach a default signature to all your outgoing messages. See <a href="#">“Attaching a personal signature”</a> earlier in this chapter for more information.

## Adding or updating an Address Book entry directly from a message

You can add or update an e-mail address in the Address Book directly from the body of a received e-mail message.

To add a new Address Book entry:

1. On the Message screen, press Function  + Menu , select Options, and then select Add to Address Book.

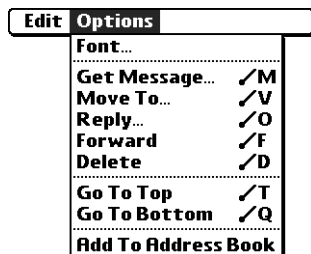

A dialog box appears with the “From” address displayed. If a Display Name exists for this Address Book entry, the Last name and First name fields show the display name.

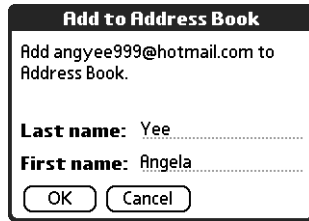

2. (Optional) If the Last name and First name fields are blank, enter the first and last name associated with the “From” e-mail address.
3. Tap OK to add the e-mail address to the Address Book, and then tap OK in the confirmation dialog box.

You can also update an existing Address Book entry with a new e-mail address, or create a second Address Book entry for a name that has an existing record. The procedure is the same as for adding a new Address Book entry. If you tap Add to Address Book from the body of an e-mail message and a record already exists for the recipient name, you are prompted either to update the e-mail address for the recipient or to create a new record for the recipient.

## Synchronizing e-mail between the handheld and the desktop

---

**IMPORTANT** You must have a Windows computer to synchronize e-mail between your handheld and your computer.

---

To manage your e-mail on your desktop as well as on your handheld, you can synchronize an e-mail account on the handheld with an e-mail application on the desktop. You can use many popular e-mail applications, called *clients*, such as Microsoft Outlook, Eudora, Lotus Notes, Outlook Express, or any other e-mail clients that use MAPI.

This chapter describes the following:

- Starting the Palm VersaMail HotSync Conduit
- Configuring and activating accounts in the HotSync Manager
- Synchronizing e-mail on the handheld with a desktop e-mail application
- Converting attached files using attachment conversion plug-ins

## Configuring an account in HotSync Manager

Before synchronizing an e-mail account, you configure the account's settings in the Palm VersaMail HotSync Conduit. The settings have to be specified only once unless you need to make changes.

To start Palm VersaMail HotSync Conduit:

1. Click the HotSync Manager icon  in the Windows system tray.
2. Select Custom.
3. Select VersaMail in the Conduit list.

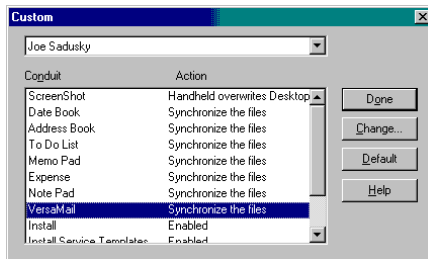

4. Click Change.
5. Select Synchronize Active Accounts.

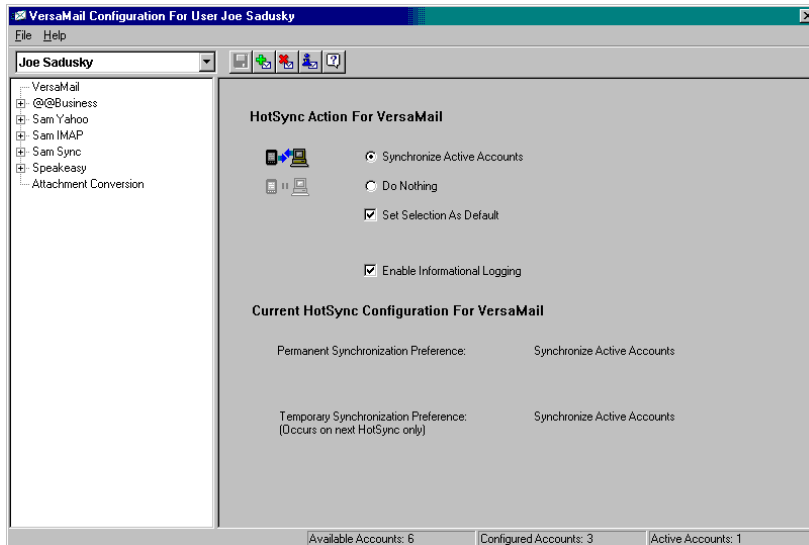

6. (Optional) Select the check box Enable Informational Logging if you want the HotSync log to record information, such as errors encountered, about the conduit during a HotSync operation.
7. (Optional) Select the check box Set Selection As Default to make the current settings the default settings for all accounts.

## Setting synchronization options and account settings

Next, you must configure each e-mail account's general synchronization settings. For example, if you created an Earthlink e-mail account on the handheld and want to synchronize that with the desktop, set the synchronization options for the Earthlink account. During a HotSync operation, the Earthlink account on the handheld and the e-mail application specified in the conduit are synchronized.

To configure an account and set the synchronization options:

1. On the VersaMail Configuration For User ... screen, click the plus sign to the left of the account you want to configure.

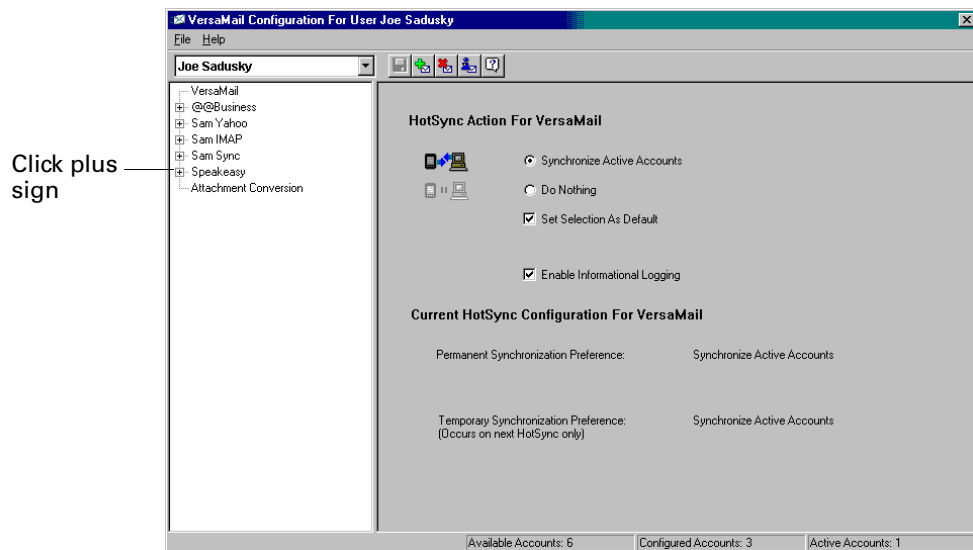

2. Under the account name, click Mail Client Sync Setup.

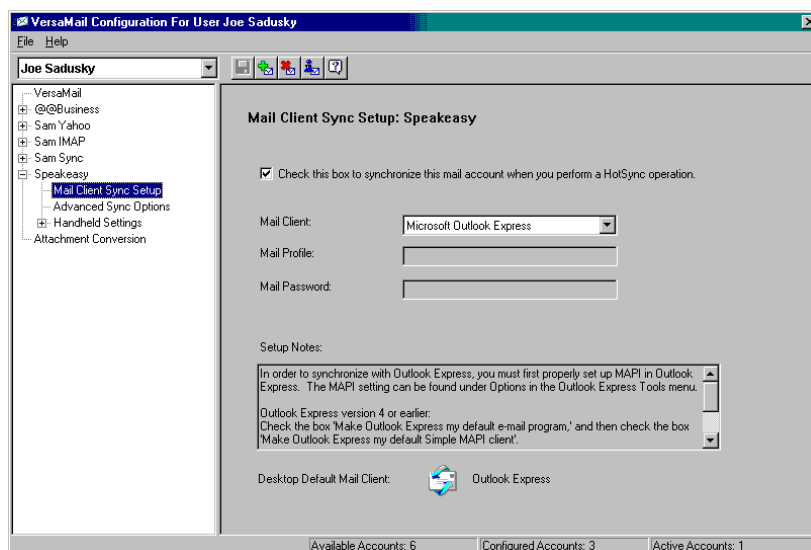

3. Select the option Check this box to synchronize this mail account when you perform a HotSync operation; otherwise, the account cannot be synchronized.

- Click the Mail Client pick list and select the desktop e-mail application you will use to synchronize the selected account with your handheld. For each application, additional setup information is displayed in the Setup Notes box. See the following table for additional setup information for each client.

**TIP** If your e-mail application is compatible with Extended MAPI, try Microsoft Exchange 5.0 or later as a choice for the Mail Client option. If your e-mail application is compatible with Simple MAPI (SMAPI), try Microsoft Outlook Express as a choice for the Mail Client option. Although Netscape uses SMAPI, Netscape is not supported.

(Optional) If prompted, enter profile and password information for the client you selected.

---

**IMPORTANT** You must select the synchronize check box and select a mail client in order to synchronize the account between your desktop and your handheld.

---

Mail Client	Action
Microsoft Exchange 5.0 or later	Select a MAPI profile to access the mail server. The conduit displays any existing MAPI profiles in the list. Enter your password for Exchange.
Microsoft Outlook 97 or later	Select the MAPI profile to access the mail server. The conduit checks for any existing MAPI profiles and displays them in the list. Enter your password for Outlook. See <a href="#">“Configuring Microsoft Outlook”</a> later in this chapter for the changes you need to make in Outlook.
Microsoft Outlook Express 5.5 or later	If you select Microsoft Outlook Express, enter the password for your e-mail account. See <a href="#">“Configuring Microsoft Outlook Express”</a> later in this chapter for details.
Lotus Notes	Enter your Lotus Notes ID and password. Click Browse if you need to locate your Notes ID.  If you want to synchronize to a local mail file instead of a server mail file, select the Synchronize to local (replicated) mail file check box. You must do all of the following in order to synchronize to a local mail file: <ul style="list-style-type: none"><li>■ Replicate the server mail file to the desktop.</li><li>■ Make sure the replicated mail file is in the Notes data directory.</li><li>■ If you have performed a custom Notes installation and have replicated the server mail file to another directory on your desktop, make sure that it is the path found in the notes.ini file.</li></ul>
Eudora 5.0 or later	See <a href="#">“Configuring Eudora”</a> later in this chapter for more information about the settings to make in Eudora.



Mail Client	Action
Direct POP connection to server	<p data-bbox="607 289 1414 569">Select this option to synchronize an account by connecting directly with a POP server. You must enter the information about the server in the VersaMail application on your handheld when you create the e-mail account to access the server. You will enter information about the incoming (POP) server, the outgoing (SMTP) server, your e-mail username, your password, and your e-mail address. You can change these settings under Handheld Settings in the conduit; see the procedure for setting handheld synchronization settings later in this chapter.</p> <p data-bbox="607 583 1414 835">During the HotSync operation, the conduit reads the settings you made. If the settings do not exist or all server information is wrong, an error is reported in the HotSync.log file. However, if the incoming server (POP) is correct, the Inbox is synchronized if the option to synchronize the Inbox is selected. If the outgoing server (SMTP) is correct, the Outbox is synchronized (send e-mail) if you selected the option to synchronize the Outbox. If neither is correct, then nothing happens.</p> <p data-bbox="607 867 1414 989">If you want to synchronize e-mail for an account that requires APOP authentication, you must select the option to use APOP on your handheld. <a href="#">“Adding APOP to an account”</a> later in this chapter for details.</p> <p data-bbox="607 1003 1414 1157">If you want to synchronize e-mail for an account that requires ESMTP authentication (for example, Yahoo accounts require ESMTP authentication), you must select the option to use ESMTP on your handheld. <a href="#">“Adding ESMTP to an account”</a> later in this chapter for details.</p> <p data-bbox="607 1171 1414 1230">The conduit does not support SSL for accounts set up as direct POP.</p>

Mail Client	Action
Direct IMAP connection to server	<p>Select this option to synchronize an account by connecting directly with an IMAP server. You must enter the information about the server in the VersaMail application on your handheld when you create the e-mail account to access the server. You will enter information about the incoming (IMAP) server, the outgoing (SMTP) server, your e-mail username, your password, and your e-mail address. You can change these settings under Handheld Settings in the conduit; see the procedure for setting handheld synchronization settings later in this chapter.</p> <p>During the HotSync operation, the conduit reads the settings you made. If the settings do not exist or all server information is wrong, an error is reported in the HotSync.log file. However, if the incoming server (IMAP) is correct, the Inbox is synchronized if the option to synchronize the Inbox is selected. If the outgoing server (SMTP) is correct, the Outbox is synchronized (send e-mail) if you selected the option to synchronize the Outbox. If neither is correct, then nothing happens.</p> <p>If you want to synchronize e-mail for an account that requires ESMTP authentication (for example, Yahoo accounts require ESMTP authentication), you must select the option to use ESMTP on your handheld. <a href="#">“Adding ESMTP to an account”</a> later in this chapter for details.</p> <p>The conduit does not support SSL for accounts set up as direct IMAP</p>
Other e-mail applications	<p>Select Microsoft Exchange 5.0 or later as a choice for the Mail Client option if your e-mail application is compatible with extended MAPI. If your e-mail application is compatible with SMAPI, select Microsoft Outlook Express as a choice for the Mail Client option.</p>

**NOTE** A profile contains configuration information, such as the location of incoming e-mail, your personal address book, and other information services that you can use. The profile may be MS Exchange Settings, your name, or something different. For more information on profiles, see your e-mail application’s documentation.

- Under the account name, click Advanced Sync Options.

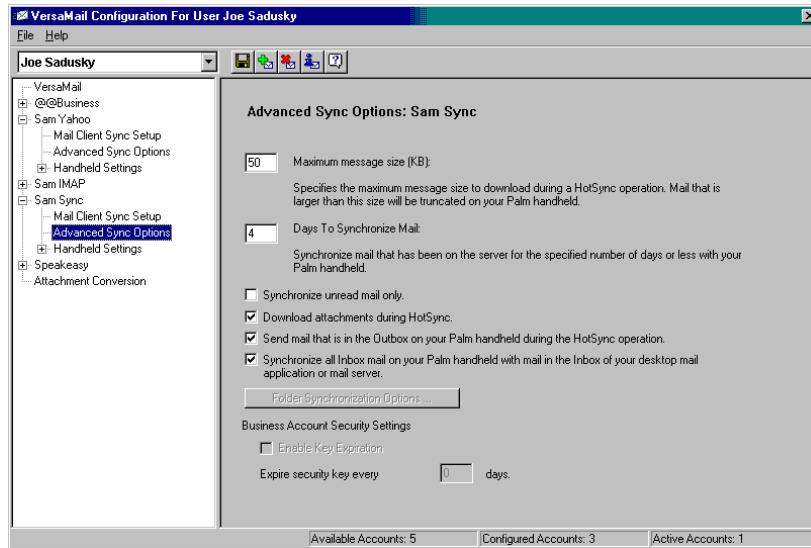

- Enter the synchronization options you want:

**Maximum message size (KB)**

Enter the maximum message size from 1 to 2048KB. If the message exceeds the maximum size, the conduit truncates the message. For example, the maximum message size might be 50KB, and the message might have the following:

- Message header: 1KB
- Body: 20KB
- Attachment: 140KB
- Attachment: 220KB

In this case the conduit puts the message header, body, and attachment 2—totaling 41KB—on the handheld. Attachment 1 is removed because adding it to the message causes the message to exceed the maximum.

**Days To Synchronize Mail**

Set how many days of e-mail, between 0 and 999, that e-mail should be synchronized. A value of 0 synchronizes all e-mail in the Inbox during the next HotSync operation. For other values, the conduit synchronizes e-mail for today and the number of days preceding today. For example, if you enter a value of 2, e-mail is synchronized for today and yesterday, but if you enter 3, e-mail is synchronized for today, yesterday, and the day before.

- Synchronize unread mail only**      Select whether to synchronize all e-mail between your desktop and your handheld, or unread e-mail only. By default, the check box is deselected, meaning that all e-mail will be synchronized.
- Download attachments**      Select whether to download attachments during synchronization. By default, the check box is selected; if unselected, only the body text of any message containing an attachment will be downloaded to your handheld during synchronization.
- Send e-mail from Outbox**      Select the check box to send any e-mail in the handheld's Outbox during the next HotSync operation.
- Synchronize incoming e-mail**      Select the check box to synchronize the Inbox during the next HotSync operation.

7. (Optional) If you chose Microsoft Outlook, Microsoft Exchange, Lotus Notes, or Direct IMAP as your mail client, click Folder Synchronization Options.

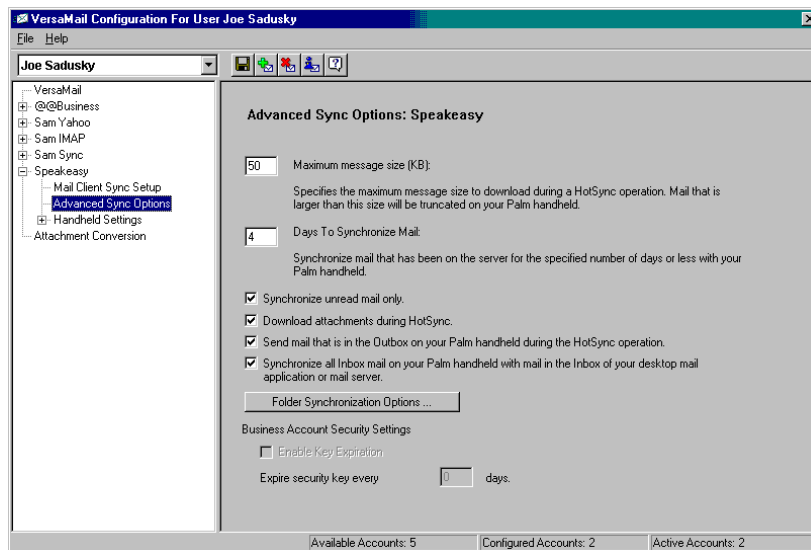



**To set handheld synchronization settings:**

1. Under the selected account name, click the plus sign to the left of Handheld Settings.

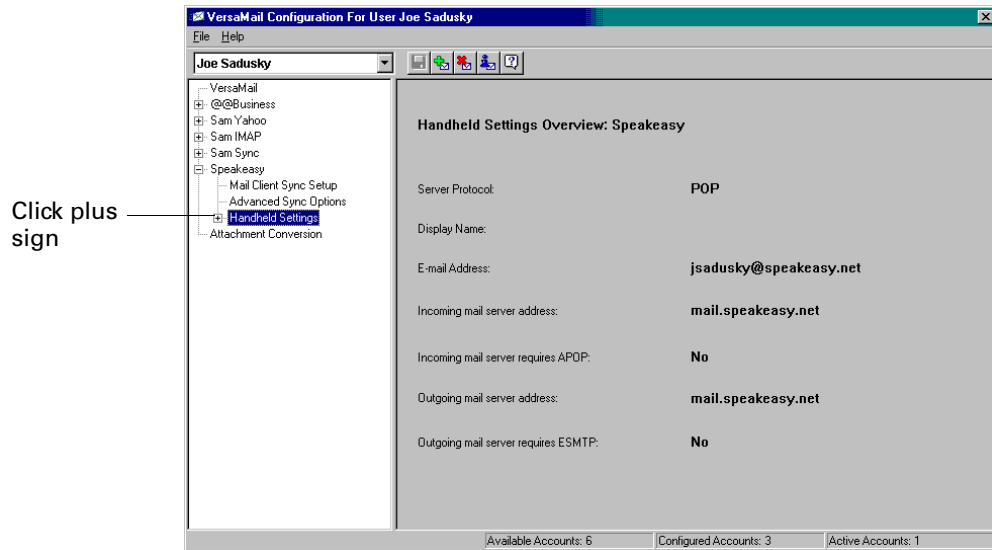

2. Click Account Information

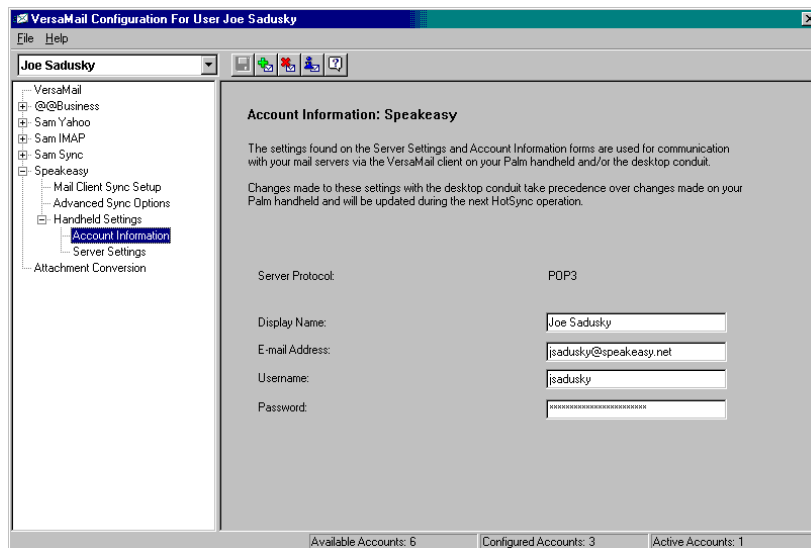

3. If you are using an account that is already configured on your handheld, the account information will already be entered. If not, enter the following:

**NOTE** You do not need to fill in these fields if the account is a synchronize-only account and the mail client is *not* Direct POP or Direct IMAP.

- Display Name** Enter the name you want to appear on your outgoing messages, such as "Joe Smith."
- E-mail Address** Enter the e-mail address of the account you are accessing, such as `examplename@yahoo.com`.
- Username** Enter the username you use to access your e-mail. This is generally the part of your e-mail address appearing before the @ symbol; it is usually not your entire e-mail address.
- Password** Enter the password for this account.

4. Under Handheld Settings, click Server Settings.

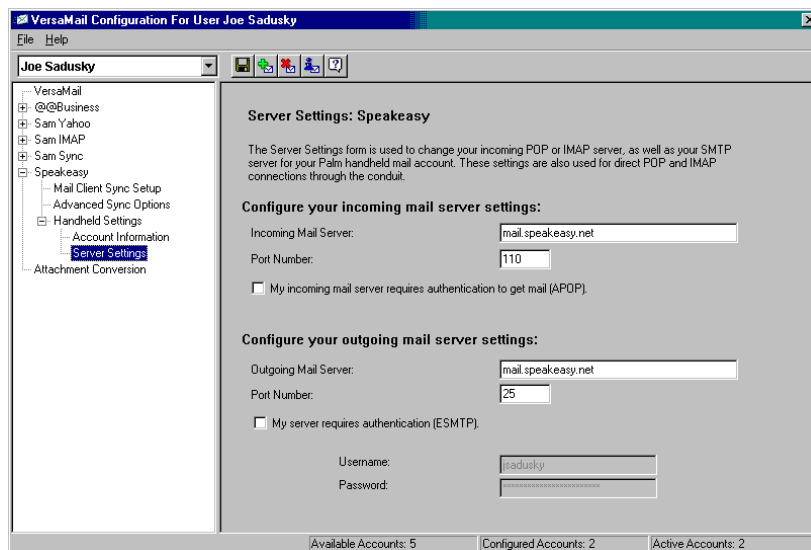

5. If you are using an account that is already configured on your handheld, the account information will already be entered. If not, enter the following:

**NOTE** You do not need to fill in these fields if the account is a synchronize-only account and the mail client is *not* Direct POP or Direct IMAP.

- Incoming Mail Server** Enter the name of your incoming (POP) mail server, such as `pop.mail.yahoo.com`.

<b>Incoming Mail Server Port Number</b>	The default is 110 for POP and 143 for IMAP servers. If you are not sure about the correct port number, check with your mail server administrator.
<b>Whether this account requires APOP authentication (POP accounts only)</b>	Selecting this check box encrypts your username and password when traveling over the network. Some services require APOP to work properly, while others do not work properly if APOP is used. If you aren't sure if your ISP or web e-mail provider supports APOP, check with your e-mail provider. <a href="#">“Adding APOP to an account”</a> later in this chapter.
<b>Outgoing Mail Server</b>	Enter the name of your outgoing (SMTP) mail server, such as smtp.mail.yahoo.com.
<b>Outgoing Mail Server Port Number</b>	The default is 25, the port number most SMTP servers use. If you are not sure about the correct port number, check with your mail server administrator.
<b>Whether this account requires ESMTP authentication</b>	Select this check box if the outgoing server (SMTP) requires authentication. Check with your system administrator before selecting this option. See <a href="#">“Adding ESMTP to an account”</a> later in this chapter for information. If you select this option, username and password fields appear. These fields are already filled in based on the account information you entered previously. In most cases, the information displayed is correct; however, occasionally your authentication username and/or password is different from your account username or password. Check with your e-mail service provider for authentication username and password information.  If you need to enter new information, enter a username and/or tap the Password box and enter a password, and then tap OK.

6. Click the Save icon  on the toolbar to save the settings for this account.

### Account information screens

Two screens in the Palm VersaMail HotSync Conduit provide summary information on your accounts:

- The Account Overview screen indicates whether the account is active; whether the account has been synchronized and, if so, the last synchronization date; the



mail client for this account; and whether the mail client and/or the incoming mail server has been changed since the last HotSync operation.

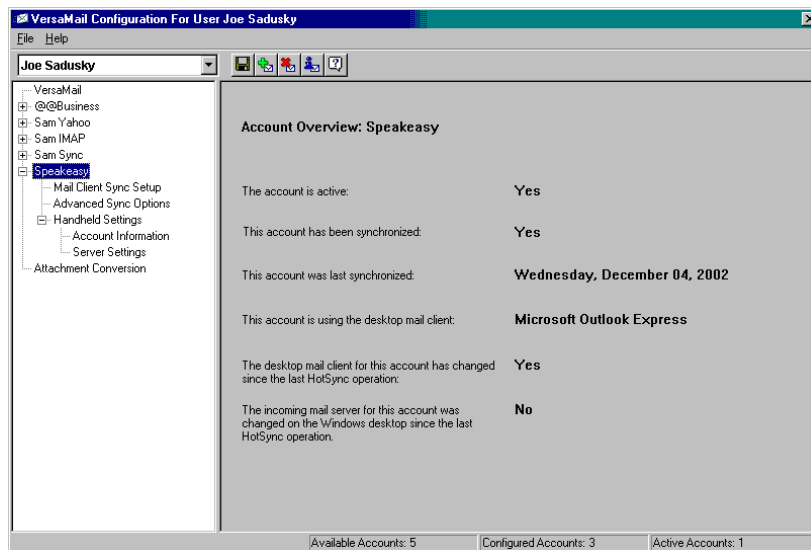

- The Handheld Settings Overview screen lists the server protocol, display name, e-mail address, incoming and outgoing mail server addresses, and whether APOP or ESMTP authentication is required.

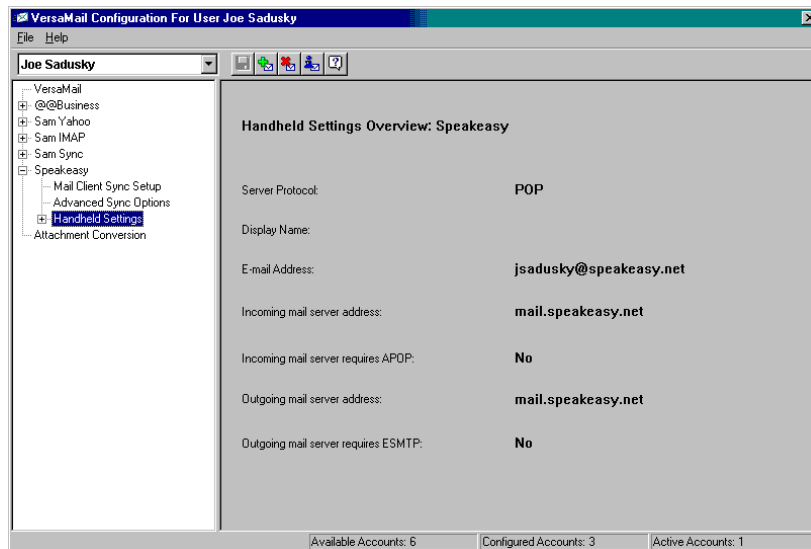

**To view the Account Overview screen:**





- Click the selected account name.

**To view the Handheld Settings Overview screen:**

- Under the selected account name, click Handheld Settings.

### Palm VersaMail HotSync Conduit shortcuts

You can use the icons in the toolbar to perform certain tasks quickly, such as saving account configuration settings.

Icon	Action
	Save account settings. Saves any changes you have made to an account.
	Add a new account. You are prompted to enter the account name and protocol.
	Delete an account. You are prompted to select the account to delete from a drop-down list.
	Quick Account Reference. Lists all accounts and shows whether they are active and the date they were last synchronized.
	Help. Displays the Help window with complete online help.

### Verifying handheld account settings before synchronizing accounts

Certain settings you configure on your handheld for an e-mail account must be set correctly for the synchronization process as well. Before configuring an e-mail client on your desktop for synchronization, be sure to verify the following settings on your handheld:

- **APOP, ESMTP, and SSL:** If you want to synchronize e-mail for an account that requires either APOP or ESMTP authentication (for example, Yahoo accounts require ESMTP authentication) or a secure (SSL) connection for incoming mail, you must select the option to use APOP, ESMTP, or a secure connection on your handheld. See [“Adding APOP to an account,”](#) [“Adding ESMTP to an account,”](#) and [“Using Secure Sockets Layer \(SSL\)”](#) later in this chapter for details.
- **Mail filters:** Any mail filters you have configured for an e-mail account on your handheld also apply during the synchronization process. For example, if you have set filters to accept only e-mail containing the subject words “Current Software Project,” only those same messages are synchronized between your desktop and your handheld. Be sure to turn mail filters off if you want to synchronize all messages between your desktop and your handheld. See [“Turning filters on and off”](#) later in this chapter for details.

### Configuring Microsoft Outlook

You can synchronize Microsoft Outlook 97/98/2000/XP with a VersaMail e-mail account, but you must set Microsoft Outlook as the default e-mail handler. You must check your username and password.

#### To configure Microsoft Outlook:

1. In the Control Panel, click Internet Options.

**NOTE** For Windows XP, click Network and Internet Connections, and then click Internet Options.

2. Click the Programs tab.
3. Select Microsoft Outlook as the default e-mail program.
4. Click OK.

**NOTE** Make sure your username and password are set up correctly within Microsoft Outlook.

### Configuring Microsoft Outlook Express

You can synchronize a VersaMail e-mail account with Microsoft Outlook Express 5.5 or 6.0, but you must set Outlook Express as the default e-mail handler.

**NOTE** Make sure your username and password are set up correctly within Outlook Express.

#### To configure Outlook Express:

1. In the Control Panel, click Internet Options.

**NOTE** For Windows XP, click Network and Internet Connections, and then click Internet Options.

2. Click the Programs tab.
3. Select Outlook Express as the default e-mail program.
4. Click OK.

**TIP** You can also make Outlook Express the default e-mail handler within the e-mail application. From the Tools menu, select Options. Click the General tab, and then click Make Default.

### Configuring Eudora

If you are using Eudora as your e-mail application, you must set up MAPI in Eudora.

#### To set up MAPI in Eudora:

1. From the Eudora Tools menu, select Options.
2. Do one of the following:
  - If Eudora is the only e-mail application that you use, select Always as the MAPI setting.
  - If you use more than one e-mail application, select When Eudora is running as the MAPI setting.
3. Ensure that your username and password are set up correctly within Eudora. This information is needed to log in to Eudora to retrieve and synchronize your e-mail.

---

**IMPORTANT** Eudora must be running in order for you to perform a HotSync operation. The VersaMail application synchronizes with your Dominant Personality in Eudora 5.1 or later.

---

### Converting attached files

You can use attachment conversion plug-ins to convert attached files that you are receiving. Your handheld comes with DataViz Documents To Go version 5 installed, and Documents To Go plug-ins are automatically configured. Documents To Go enables you to convert attachments using HotSync operations. With Documents To Go, you can view Word, Excel, and PowerPoint attachments on your handheld. See the *Documents To Go Getting Started Manual* for more information.

When you receive a message with an attachment on your handheld, the file is converted to the DataViz format on the handheld when you perform a HotSync operation. You can then read and edit the file in Documents To Go on the handheld.

In the Palm VersaMail HotSync Conduit, you can turn off DataViz Documents To Go plug-ins or select other plug-ins.

#### To turn off attachment conversion plug-ins:

1. Click the HotSync Manager icon  in the Windows system tray.
2. Select Custom.

## 3. Select VersaMail in the Conduit list.

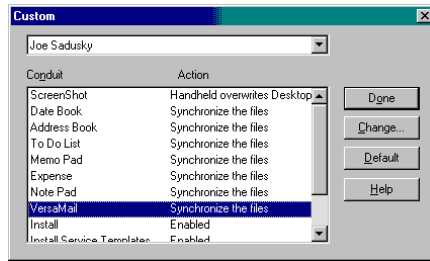

## 4. Click Change.

## 5. Click Attachment Conversion.

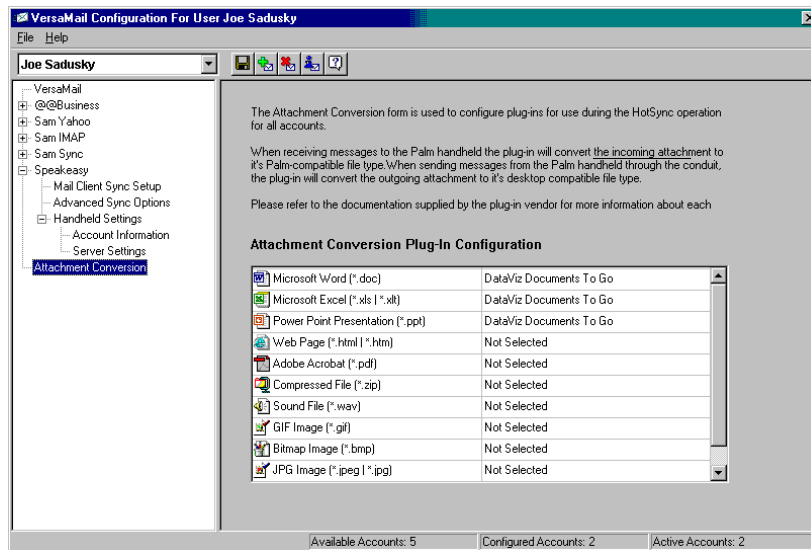

Plug-in types are listed in the left column. If the plug-in is selected, the right column shows the name of the company supplying the plug-in. If a plug-in is not selected, the right column reads Not Selected.

**NOTE** The drop-down lists in the right column display only the companies currently supplying plug-ins for a particular type. If more than one company supplies a plug-in of a particular type (for example, Word doc), then multiple company names appear on the list. If no company is currently supplying a plug-in of a particular type, then the only option that appears on the list is Not Selected.

## 6. Do one of the following:

Item	Action
To deselect a plug-in	Click the right column next to the plug-in type name, and then select Not Selected from the drop-down list.
To select a plug-in	Click the right column next to the plug-in type name, and then select the name of the company supplying the plug-in from the drop-down list.
To change the company supplying a plug-in of a particular type	Click the right column next to the plug-in type name, and then select the name of the company you want to supply the plug-in from the drop-down list.

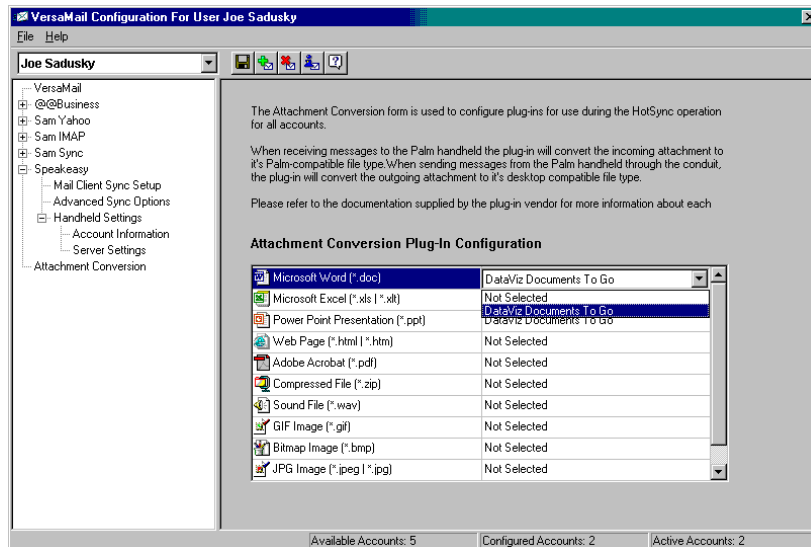

## 7. Click save.

## Synchronizing an account

To synchronize accounts, you must set the HotSync action for the VersaMail application in the HotSync Manager. You can, however, exclude e-mail accounts from a HotSync operation.

**TIP** If you don't want an account synchronized, deselect the check box Select this check box to synchronize this e-mail account when you perform a HotSync operation.

To select which accounts are synchronized during a HotSync operation:

1. Click the HotSync Manager icon  in the Windows system tray.
2. Select Custom.

3. Select VersaMail in the Conduit list.

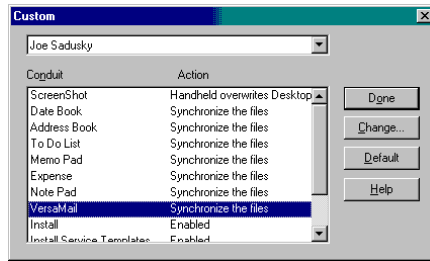

4. Click Change.
5. Select one of the following:

**Synchronize Active Accounts**

Select this option to include active accounts in the next HotSync operation. For an account to be synchronized, you must have selected the option Check this box to synchronize this mail account when you perform a HotSync operation.

**Do Nothing**

Select this option to exclude e-mail accounts from the next HotSync operation.

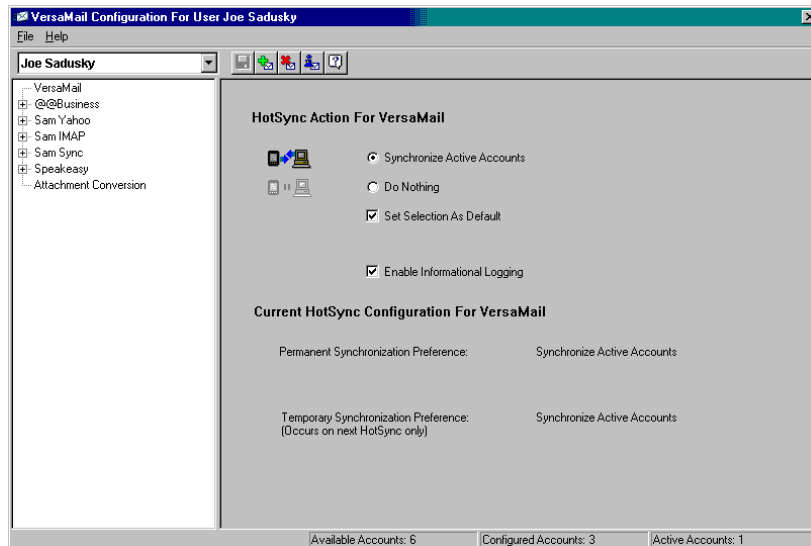

6. (Optional) Select Set Selection As Default to apply the options you selected to all subsequent HotSync operations. Otherwise, the settings apply to the next HotSync operation only.
7. Click OK.
8. Perform a HotSync operation.

### Synchronizing multiple accounts

You can synchronize more than one account during the same HotSync operation.

**NOTE** If you want to synchronize both a Microsoft Outlook and a Microsoft Outlook Express account, you must have Microsoft Outlook set as the default e-mail client on the desktop.

The maximum number of accounts you can synchronize are as follows:

- 1 Simple MAPI account (for example, an account set up using Outlook Express or Eudora)
- 1 Extended MAPI account (for example, an account set up using Outlook)
- 1 Lotus Notes account
- 5 combined direct POP or direct IMAP accounts

If you attempt to synchronize more than the limit for a particular type of account during a HotSync operation, you will receive an alert prompting you to deactivate any accounts over the allowed number.

### Using SSL with the conduit

When you set up an e-mail account, you can choose to use a secure connection (Secure Sockets Layer, or SSL) for sending and receiving e-mail messages. The Palm VersaMail HotSync Conduit supports SSL when synchronizing with an e-mail account only if that account uses one of the following desktop e-mail applications (mail clients):

- Outlook
- Outlook Express
- Eudora

The conduit does not support SSL for accounts set up as direct POP or direct IMAP or for Microsoft Exchange or Lotus Notes accounts.

### Going beyond the basics

You use many of the VersaMail application features, such as getting and sending e-mail, daily. Other features are used less frequently but are especially valuable in certain situations. For example, filtering e-mail is helpful if you are traveling and want to receive messages only from certain people or about specific subjects. Filters and other special features are discussed in this chapter.

This section describes the following:

- Creating and using filters to determine which e-mail you actually view
- Managing mail settings
- Adding APOP to an account



- Adding ESMTP to an account
- Setting advanced account options
- Cutting and copying text from an e-mail message for use in other applications
- Using the command bar
- Viewing e-mail header details
- Backing up your mail databases
- Synchronizing IMAP folders wirelessly
- Using Secure Sockets Layer (SSL)
- Viewing the wireless coverage indicator

The section ends with a summary of the VersaMail application navigator controls and keyboard shortcuts.

## Managing mail filters

Filters provide efficient ways to manage e-mail retrieval and storage. When you tap Get Mail or Get & Send, filters determine which e-mail messages are downloaded to your handheld and in which folder the downloaded messages are stored.

For example, you may want to file e-mail about sales meetings in a Sales folder. You can create a filter that automates this action, so that whenever you receive e-mail about sales meetings, it is immediately sent to the Sales folder, which you created on the filters screen.

### Creating mail filters

To create a mail filter, you select various criteria, such as To, From, and Contains. This information makes up the filter statement.

For example, if you want stock quotes from your online brokerage service sent to a folder you created called Finance, you can filter those e-mail messages and store them in the Finance folder. The filter statement, which is displayed in the Filter Editor, is shown in the following figure.



**IMPORTANT** If you create a filter, only messages that meet the filter criteria are downloaded to your handheld. You do not see any other messages that have been sent to you, even in your Inbox. To avoid this, you must set up two filters as described in the following procedure. Using the example above, the first filter would have all mail containing “onlinebroker” in the “From” field moved to the “Finance” folder. For the second filter, you should specify that all mail NOT containing “onlinebroker” in the “From” field should be moved to the Inbox (or other folder you designate). If you do not create this second filter, then only messages containing “onlinebroker” in the “From” field are downloaded to your handheld.

To create a filter:

1. From the Inbox or another folder, press Function  + Menu .
2. Select Options, and then select Filters.



3. Tap New.
4. Enter a short description of the filter in the Name field.



5. Use the If the pick lists to create criteria for the filter.

The three pick lists and the edit line combine to create a statement that identifies the type of e-mail and where you want the e-mail stored. For example, a filter might read, “If the [Subject] [Contains] sales meeting, Then get mail and move

to [Sales].” When you use this filter to sort incoming e-mail, any e-mail containing sales meeting in the subject line is filed in the Sales folder.

- To pick list** Select the message header field with the information contained in the edit line: To, From, Subject, cc, Date, Size. For example, you might select Date to download only messages that are less than a certain number of days old.
- Contains pick list** Select a filter action: Contains, Starts with, Does NOT Contain.
- Edit line** Enter the text that must be found in the header field. For example, if you want to sort e-mail with the subject Sales, enter “Sales.” If you enter more than one criteria, separate each with a comma—for example, Sales, New York.
- Then get mail and move to pick list** Select the folder or mailbox into which you want your filtered e-mail to go. You can also create a new folder for storing the incoming e-mail. Tap Edit Folders, and then create a new folder or delete or rename existing ones.

6. Tap OK, or press Function  + Enter .

The filter appears in the Filters list.

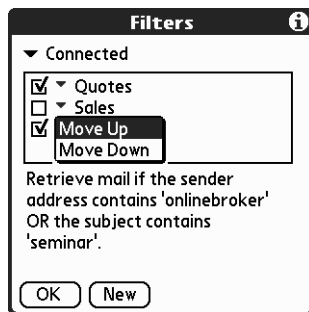



Selected filters execute in the order in which they appear on the list. Move filters up and down the list to ensure that they execute in the correct order.

**NOTE** Filters created on the handheld also apply to e-mail synchronization. See [“Synchronizing an account”](#) earlier in this chapter for more information.

### Turning filters on and off

By default, a filter that is turned on or selected affects all subsequent downloads of e-mail until you deselect it. More than one filter can be in effect at once. Before you download e-mail, be sure to turn on the filters you want and turn off those you don't want.

To turn a filter on or off:

1. Press Function  + Menu .
2. Select Options, and then select Filters.

The Filters dialog box appears with the filters you created.

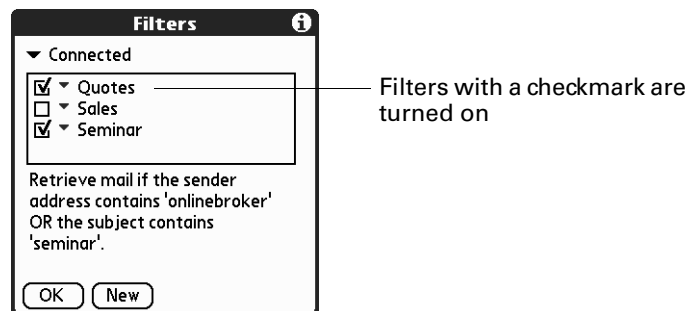

3. Tap the pick list in the upper-left corner, and select Connected or Synchronize.

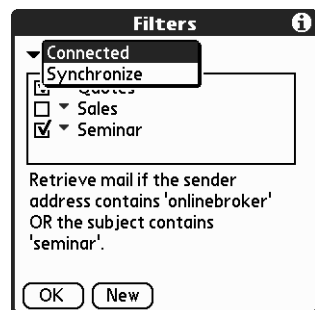



- Connected applies a filter to messages downloaded to your handheld over a modem or network connection.
  - Synchronize applies a filter to messages downloaded to your handheld during a HotSync operation.
4. Tap the filter check boxes to select the filters you want to use for subsequent e-mail transactions.

---

**IMPORTANT** If you deselect a filter listed under Connected, be sure that the filter is deselected also under Synchronize.





---

5. Tap OK, or press Function  + Enter .

### Editing or deleting a filter

You can edit a filter to change its name or the criteria in the filter.



To edit or delete a filter:

1. Press Function  + Menu .
2. Select Options, and then select Filters.
3. Tap the name of the filter.
4. Do one of the following:
  - To edit the filter, revise your entry in the Name field and/or your selections in the pick lists, and revise the text in the edit line. Tap OK.
  - To delete the filter, tap Delete, and then tap Yes to confirm the deletion.
5. Tap OK, or press Function  + Enter .

### Managing mail settings

You can configure advanced mail settings such as server information, incoming and outgoing mail server options, and more, for each e-mail account.

To select the account whose settings you want to manage:

1. In your Inbox or on another folder screen, press Function  + Menu .
2. Select Options.

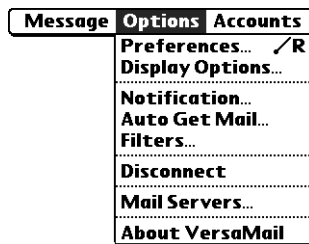

3. Select Mail Servers.

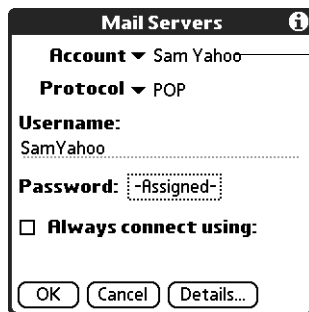

Shows server settings for current account. Tap the Account pick list to edit the account.

4. Tap the Account pick list, and then tap Edit Accounts.

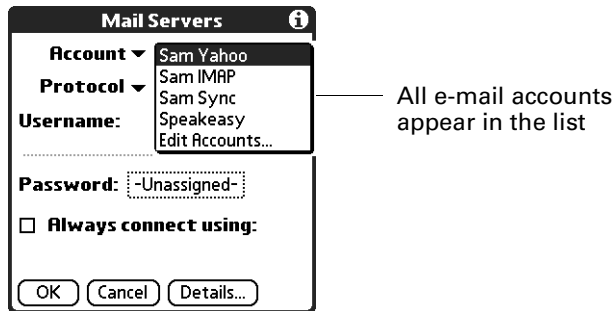

5. Tap the name of the account whose settings you want to manage, and then tap OK.

**To change the protocol type:**

1. On the Server Settings screen, tap the Protocol pick list, and then tap POP or IMAP.





2. Tap OK, or press Function  + Enter .

**To change your username or password:**

1. On the Server Settings screen, enter a new username.

Your username is typically the first part of your e-mail address, which appears before the @ symbol.



2. Tap the Password box, and enter a new password in the Password Entry dialog box. The VersaMail 2.5 application provides strong 128-bit AES encryption for your password.
3. Tap OK, or press Function  + Enter .

To set a default service for this account (different from the default service for your handheld):

1. On the Server Settings screen, tap the Always Connect Using check box.

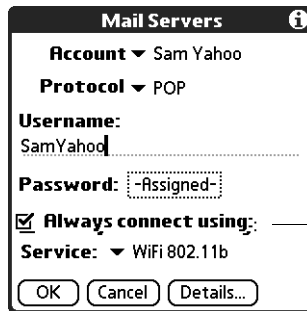

Tap to change the service connection for this e-mail account only from your default handheld service connection

2. Tap the connection type you want from the Services pick list.

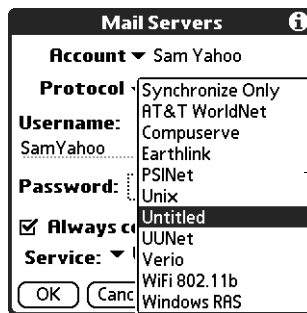

Select a service connection for this e-mail account only

3. Tap OK, or press Function  + Enter .

**NOTE** Select this option only if you want an e-mail account to use a different service from the default service you set for your handheld. For example, you may have selected a default service that uses the built-in 802.11b radio on your handheld to make a dial-up connection with your corporate account through a VPN. However, for your Earthlink account, you may want to switch to the Earthlink service, which uses a Bluetooth card inserted into your handheld's card expansion slot to make a connection with your GPRS service provider. To do this, tap the Always connect using check box, and then select Earthlink from the Services pick list. Leave this box deselected if you want to use your default handheld service for this e-mail account.

See [Chapter 18](#) for information on setting connection types and selecting a default service for your handheld. See "[Selecting a different service for a given e-mail account](#)" earlier in this chapter for details on using a different service for a specific e-mail account.

**To change e-mail address/mail server settings:**

1. On the Server Settings screen, tap Details.
2. Tap the Options pick list and select Address/Servers.



3. Edit any of the following:

- |                             |   |
|-----------------------------|---|
| <b>Email address</b>        | Enter the e-mail address of the account you are accessing, such as examplename@yahoo.com. |
| <b>Incoming mail server</b> | Enter the name of your incoming (POP) mail server, such as pop.mail.yahoo.com.            |
| <b>Outgoing mail server</b> | Enter the name of your outgoing (SMTP) mail server, such as smtp.mail.yahoo.com.          |

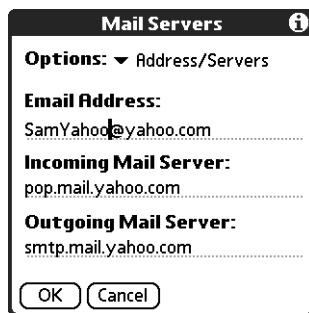

4. Tap OK, or press Function  + Enter .



**To change incoming mail server settings:**

1. On the Server Settings screen, tap Details.
2. Tap the Options pick list and select Incoming Mail.

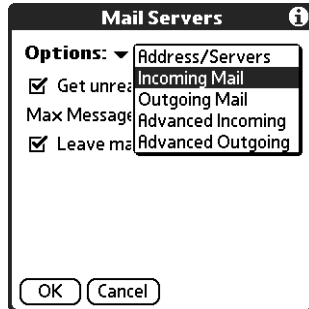

3. Select or enter either of the following:

**Get unread mail ONLY**

For IMAP accounts, retrieves unread e-mail only. To get all e-mail and not just unread e-mail, deselect Get unread mail ONLY.

**Maximum Message Size**

Shows the maximum message size that you can receive.

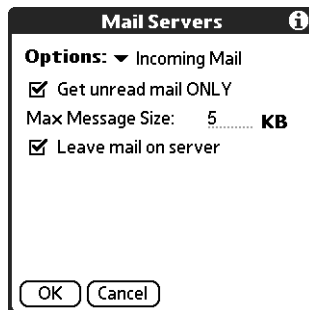

4. Tap OK, or press Function  + Enter .

To set additional incoming mail options:

1. On the Server Settings screen, tap Details.
2. Tap the Options pick list and select Advanced Incoming.

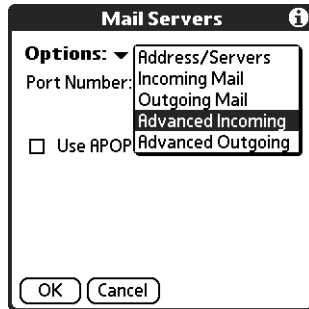

3. The incoming mail options are different depending on the connection type you selected and the server protocol—POP or IMAP.

POP accounts

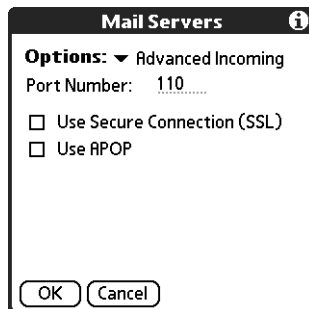

IMAP accounts

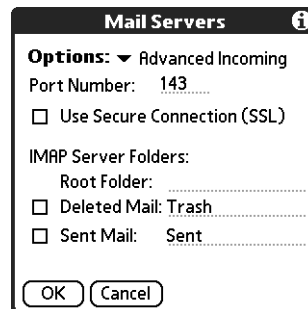

<b>Port Number</b>	Defaults to 110 for POP and to 143 for IMAP servers. If you are not sure about the correct port number, check with your mail server administrator.
<b>Secure Connection</b>	Retrieves incoming mail over a secure (Secure Sockets Layer, or SSL) connection. See <a href="#">“Using Secure Sockets Layer (SSL)”</a> later in this chapter for information on SSL.
<b>Leave mail on server (POP only)</b>	Leaves e-mail that you receive on the handheld on the server also.
<b>Use APOP (POP only)</b>	Encrypts your username and password when traveling over the network. Some services require APOP to work properly, while others do not work properly if APOP is used. If you aren’t sure if your ISP or web e-mail provider supports APOP, check with your e-mail provider. See <a href="#">“Adding APOP to an account”</a> later in this chapter.
<b>Mailbox (IMAP only)</b>	Defines the root mailbox on your IMAP server.

- Deleted Mail (IMAP only)** Stores deleted e-mail in the folder you specify on the server. This field is case sensitive, so spell the folder name exactly as it is on the server. For example, if your Deleted Mail folder is called Trash on the server, you must enter Trash in this space.
- Sent Mail (IMAP only)** Shows the name of your Sent Mail folder on the server. This field is case sensitive, and the folder name should be spelled exactly as it is on the server.

If you are using the Palm VersaMail HotSync Conduit and have an IMAP account, you must configure the outgoing mail settings to send mail.

**To set outgoing mail server (SMTP) settings:**

1. On the Server Settings screen, tap Details.
2. Tap the Options pick list and select Outgoing Mail.

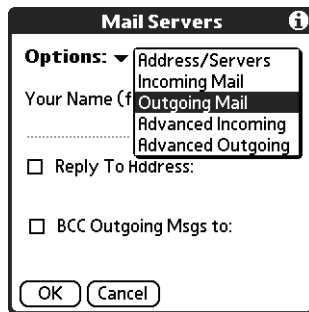

3. Enter any of the following:

- Display Name** Enter the name you want to appear on your outgoing messages, such as "Joe Smith."
- Reply To Address** Enter the e-mail address that you want recipients to see and reply to on your e-mail messages, only if it is different from the e-mail address from which you are sending the message. For example, if you are sending a message from me@yahoo.com but you want recipients to reply to me@earthlink.net, enter the reply-to address here. Reply To Address makes it look like the e-mail came from the address you entered.
- BCC** Select the BCC check box to send a blind copy of any e-mail message you send to another e-mail address. The blind copy e-mail address is not seen by the other recipients of the message. For example, if you want a copy of all messages you send from your handheld to be sent to your desktop e-mail account, enter that e-mail address.

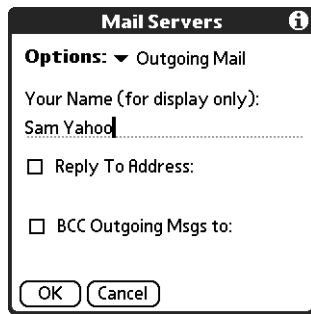

4. Tap OK, or press Function  + Enter .

To set additional outgoing mail options:

1. On the Server Settings screen, tap Details.
2. Tap the Options pick list and select Advanced Outgoing.

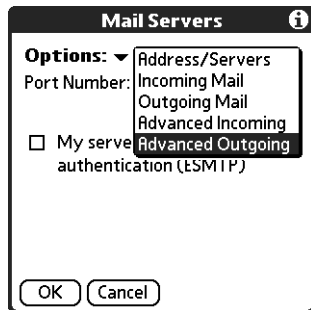

### 3. Set additional options for outgoing e-mail:

**Port Number** The default is 25, the port number most SMTP servers use. If you are not sure about the correct port number, check with your mail server administrator.

**My server requires authentication (ESMTP)** Select the My server requires authentication (ESMTP) check box if the outgoing server (SMTP) requires authentication. Check with your system administrator before selecting this option. See [“Adding ESMTP to an account”](#) later in this chapter for information. If you select this option, username and password fields appear. These fields are already filled in based on the account information you entered previously. In most cases, the information displayed is correct; however, occasionally your authentication username and/or password is different from your account username or password. Check with your e-mail service provider for authentication username and password information.

If you need to enter new information, enter a username and/or tap the Password box and enter a password, and then tap OK.

Username and Password fields appear only if ESMTP check box is selected



### 4. Tap OK twice, or press Function + Enter twice.

## Adding APOP to an account

To encrypt your username and password when they are traveling over the network, some services require APOP to work properly, while others do not work properly if APOP is used. If you aren't sure if your ISP or web e-mail provider supports APOP, check with your e-mail provider.

**NOTE** APOP works only with accounts that use the POP protocol.

To edit an account and add APOP:

1. In your Inbox or on another folder screen, press Function  + Menu .
2. Select Options.

3. Select Mail Servers.

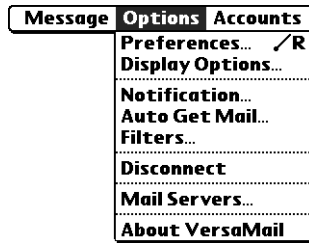

4. Tap the Account pick list and select Edit Accounts.

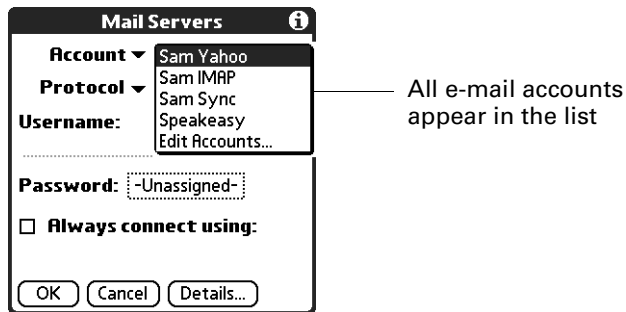

5. Tap the name of the account you want to change, and then tap OK.
6. On the Server Settings screen, tap Details.
7. Tap the Options pick list and select Advanced Incoming.

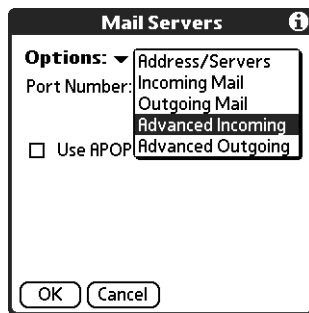

8. Select the Use APOP check box.

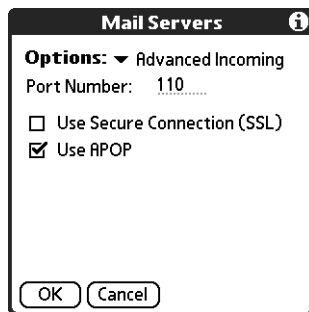



9. Tap OK, or press Function  + Enter .

## Adding ESMTP to an account

Some services require ESMTP authentication to validate your username and password on an SMTP server. If you aren't sure if your ISP or web e-mail provider supports ESMTP, check with your e-mail provider.

To edit an account and add ESMTP:

1. In your Inbox or on another folder screen, press Function  + Menu .
2. Select Options.
3. Select Mail Servers.

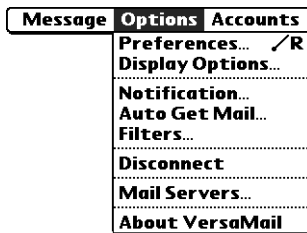

4. Tap the Account pick list and select Edit Accounts.

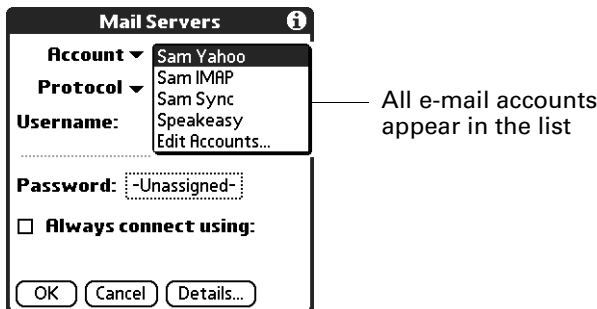

5. Tap the name of the account you want to change, and then tap OK.
6. On the Server Settings screen, tap Details.
7. Tap the Options pick list and select Advanced Outgoing.

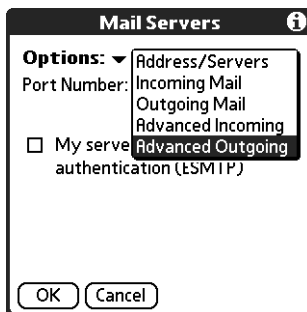

8. Select the My server requires authentication (ESMTP) check box if the outgoing server (SMTP) requires authentication. Check with your system administrator before selecting this option. If you select this option, username and password fields appear. These fields are already filled in based on the account information you entered previously. In most cases, the information displayed is correct; however, occasionally your authentication username and/or password is different from your account username or password. Check with your e-mail service provider for authentication username and password information.

If you need to enter new information, enter a username and/or tap the Password box and enter a password, and then tap OK.





Username and Password fields appear only if ESMTP check box is selected

9. Tap OK, or press Function  + Enter .

## Setting advanced account preferences

You can set advanced preferences for each e-mail account. Any preferences you set are account-specific; they apply only to the account you are currently in.

To set advanced account preferences:

1. In your Inbox or on another folder screen, press Function  + Menu .
2. Select Options.
3. Select Preferences.
4. Tap Advanced.

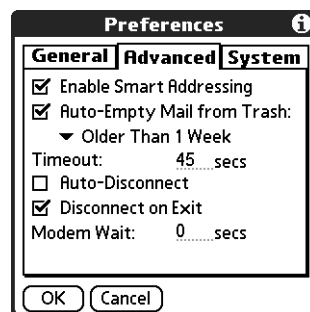



5. Select any of the following preferences:



<b>Enable Smart Addressing</b>	Types ahead and completes a recognized e-mail address. See the procedure for creating new e-mail later in this chapter for more information.
<b>Auto-Empty Mail from Trash</b>	Determines how often e-mail messages in the trash are automatically deleted. See <a href="#">“Emptying the trash”</a> earlier in this chapter for more information.
<b>Timeout</b>	<p>Sets the number of seconds to try to connect before timing out. This value can be any number greater than 0 seconds; however, if you set the number too low, your connection attempt may time out before you make a connection with the e-mail service provider.</p> <p>The default setting is 45 seconds. To change, tap the Timeout field and enter a new value.</p>
<b>Auto-Disconnect</b>	Automatically disconnects your remote connections after each command. Each command you perform initiates a new call to your ISP. This setting is not recommended if you plan to perform multiple e-mail transactions in a short amount of time.
<b>Disconnect on Exit</b>	Disconnects from the network only after you leave the VersaMail application. This feature is an alternative to Auto-Disconnect. This option keeps your connection active while you perform multiple transactions in the VersaMail application, but automatically disconnects when you move on to a different application on your handheld. If this option is not selected, you must manually disconnect from your ISP.
<b>Modem Wait</b>	Displays the number of seconds that the modem uses to initialize itself. If you have a modem, tap and enter a number of seconds for the wait. The typical setting for a wireless modem is 3, and the typical setting for most normal modems is 0.

## Cutting and copying text from an e-mail message for use in other applications

You can copy any text from an e-mail message, either from one you have composed or have read or from an attachment you have downloaded and opened (such as a Word doc), for use elsewhere in the VersaMail application or in another application. Text you can select and copy includes:



- A name
- An e-mail address
- Body text of an e-mail message or a downloaded attachment

**To copy and paste text from an e-mail message:**

1. Select the text by dragging the stylus over it.
2. Press Command  + C.
3. To paste the text elsewhere in the VersaMail application or in another application, go to the new location and press Command  + P.

You can also cut or copy text from a Word document that you download as an attachment and view on your handheld. You can then paste this text in another part of the Word document, another Word document, or another application on your handheld.

**To cut/copy and paste text from within a Word document:**

1. Select the text by dragging the stylus over it.
2. Press Command  + X.
3. To paste the text elsewhere in the VersaMail application or in another application, go to the new location and press Command  + P.

See “[Performing common tasks](#)” in [Chapter 4](#) for more information on copying and pasting.





## Using the command bar









The command bar provides shortcuts for performing numerous tasks. The options presented on the command bar may change, depending on which screen is displayed in the application. For example, if you are viewing a message in the Inbox, the command bar gives you the option of quickly moving the message to another folder. See “[Moving e-mail between folders](#)” earlier in this chapter.

**To access the command bar on your handheld:**

- Press Command  on the keyboard.

For each type of screen, the command bar offers various options.

View	Options
List (Inbox, Outbox, and so on showing list of messages)	 Select all messages.
	 Deselect all messages.
	 Change display font (toggles between large and small font).
	 Delete messages from the handheld; icon appears only if you have previously selected at least one message.
	 Empty the trash; icon appears only if you have previously deleted at least one message.

View	Options
Reading a message	<ul style="list-style-type: none"> <li> Delete message from the handheld.</li> <li> Move message to a different folder; select folder from pick list.</li> <li> Change display font (toggles between large and small font).</li> </ul>
Composing a message	<ul style="list-style-type: none"> <li> Insert the @ symbol into a recipient's e-mail address.</li> <li> Add attachment.</li> <li> Undoes last action; icon appears in command bar only if you have previously performed one of the actions above or any of the cut/copy/paste functions described below.</li> </ul>
Reading or composing a message	<ul style="list-style-type: none"> <li> Cuts selected text.</li> <li> Copies selected text.</li> <li> Pastes selected text.</li> </ul>

See [“Using menu commands”](#) in [Chapter 4](#) for more information on the command bar.

## Changing e-mail header details

When viewing a message in any folder, you can change the view of the message header. The e-mail header options are as follows:

- **Short header:** Shows sender's name or address (From field) and subject line (Subj field).

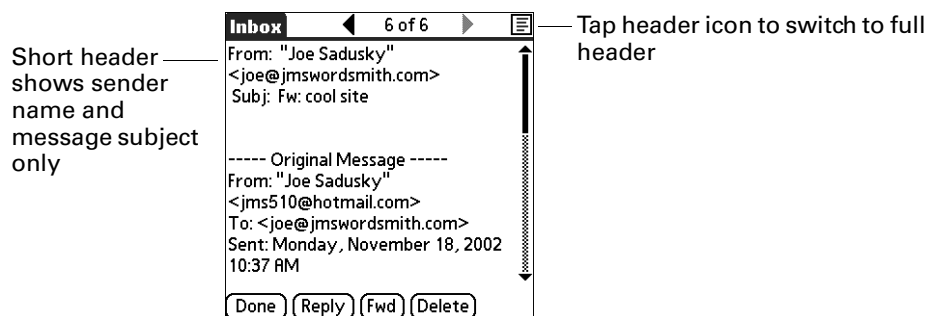

- **Full header:** Shows the following:
  - Sender's name or e-mail address (From field)
  - Subject line (Subj field)
  - Date message was composed, sent, or received (Date field)

- Size of message including any attachments (Size field)
- Recipient's name or e-mail address (To field)

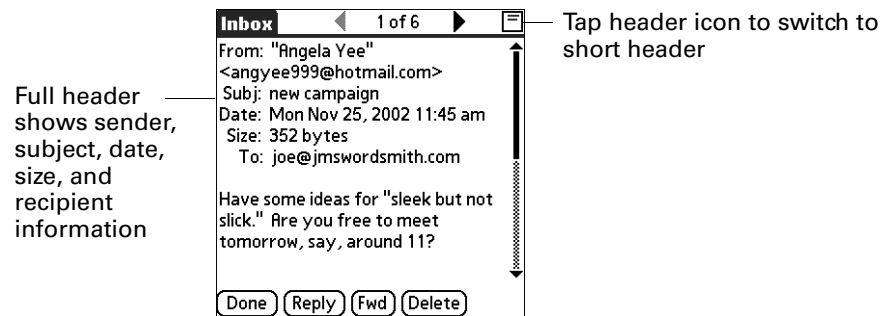

You can also switch between a short header and a full header for a message you are composing. Short header shows the To and Subject fields only; full header shows the To, cc:, bcc:, and Subject fields.

Message short header

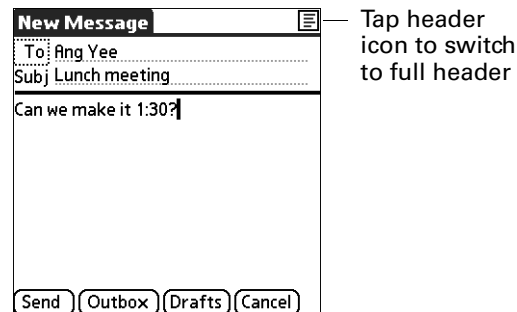

Message long header

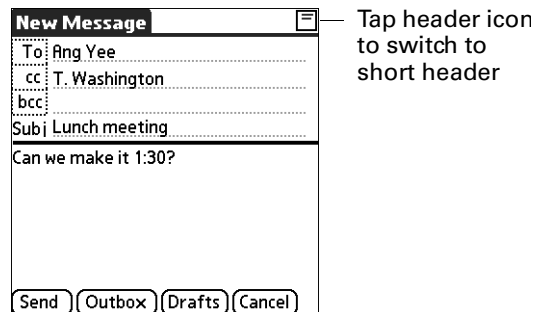

**To switch between short header and full header view:**

- Tap the header icon in the upper-right corner of the message screen.

## Backing up mail databases

In most cases your e-mail is on your server, so you do not need to back up your e-mail database from your handheld. If you want to make sure you have a current copy of all your e-mail, you can back up all the e-mail databases from the handheld.

To back up the e-mail database:

1. Press Command  + R.

Alternately, press Function  + Menu , select Options, and then select Preferences.

2. Tap System.

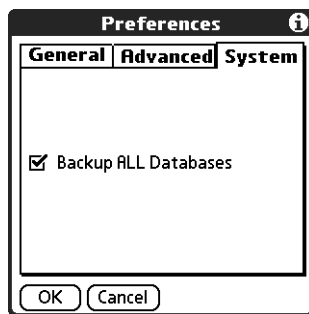

3. Tap Backup ALL Databases to select it.

**NOTE** If you don't select this option, HotSync operations are faster.

4. Tap OK, or press Function  + Enter .

## Wireless IMAP folder synchronization

If you create an IMAP folder in an account on your handheld that matches a folder on the mail server, you can wirelessly synchronize e-mail messages that you move into or out of the IMAP folder, or delete in the folder.

When you synchronize a folder, any e-mail messages in the selected folder on the mail server will be downloaded to the same folder on your handheld. Any messages moved out of the selected folder on your handheld or deleted on your handheld will be moved or deleted in the folder on the mail server.

Depending on how you have set up IMAP folders on your handheld and/or the mail server, you may have to perform some steps before you can wirelessly synchronize e-mail messages between your handheld and the server, as follows:

- If you need to create a folder on both your handheld and the server, see [“Creating and editing mail folders”](#) earlier in this chapter. Be sure to select the Also create on server check box as described in that section. After creating the folders, continue with the following procedures for synchronizing IMAP folders.

- If there is a folder on the mail server but you need to create it on your handheld, see [“Creating and editing mail folders”](#) earlier in this chapter. You do not need to select the Also create on server check box as described in that section. After creating the folder, continue with the following procedures for synchronizing IMAP folders.
- If you have a folder on your handheld that matches a folder on the mail server, continue with the following procedures for synchronizing IMAP folders.

You can synchronize server folders either during a Get Mail operation, or from a menu.

**NOTE** You can synchronize folders whose names are up to 16 characters in length. You can synchronize up to 11 custom folders you create, in addition to the default folders Inbox, Outbox, Drafts, Sent, and Trash.



**To wirelessly synchronize handheld/mail server IMAP folders during a Get Mail operation:**

1. From within an IMAP e-mail account, tap Get Mail.
2. Select the Sync IMAP Folders check box and then tap OK.



3. Select the check box next to each folder you want to synchronize. You can select more than one folder.
4. (Optional) The Subjects Only check box is selected or deselected based on the preference you set for getting mail. Select or deselect the check box to change this preference for the IMAP e-mail account only.
5. (Optional) Select the Use Filters check box to apply any filters you have created to the IMAP e-mail account. See [“Managing mail filters”](#) earlier in this chapter for information.
6. Tap OK.

**To wirelessly synchronize handheld/mail server IMAP folders from the Options menu:**

1. In your Inbox or on another folder screen of an IMAP e-mail account, press Function  + Menu .
2. Select Options.

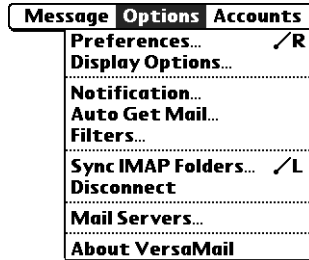

3. Select Sync IMAP Folders (alternately, press Command  + L).
4. From the pick list, select the folders you want to synchronize either by tapping the folder name or by using the navigator, as shown in the following table.

Button	Action
Select	If no folder is selected, the Select button highlights the first visible folder on the list. If a folder is selected, the Select button toggles the check box between selected and deselected.
Up or Down	If a folder is selected, use Up and Down to scroll up or down one folder on the list. If no folder is selected, use Up and Down to scroll up or down one page.
Left	If a folder is selected, deselects the folder. No function if no folder is selected.
Right	No function.

A connection is made to your e-mail service provider to update the server with changes from your handheld, and to have your handheld updated with changes from the server.

## Using Secure Sockets Layer (SSL)

Secure Sockets Layer (SSL) is a protocol designed to ensure that data you receive from a network or the Internet is secure and authentic. The VersaMail application uses SSL to help guarantee the secure transmission of e-mail messages that you receive. When you set up an account in the VersaMail application, you are given the option of selecting SSL for incoming mail. See [“Setting up and managing e-mail accounts”](#) earlier in this chapter for instructions.

The VersaMail application supports SSL for incoming mail only; for example, if AT&T is your e-mail service provider, you can receive messages over a secure (SSL) connection. You cannot send messages over a secure connection. However, there is a way that you can make it appear as though messages are being sent over a secure connection.



**To send messages so that they appear to have been sent over a secure connection:**

1. Set your outgoing mail (SMTP) server to the correct server for your e-mail account. See the procedure for entering the outgoing mail server in [“Entering the name of the incoming and outgoing mail server”](#) earlier in this chapter.
2. Set the reply-to address to an e-mail address from an e-mail service provider that supports sending messages over a secure connection (for example, AT&T). See the procedure to entering a reply-to address in [“Setting outgoing mail options”](#) earlier in this chapter.

If you set up an account that uses an SSL connection on Outlook, Outlook Express, or Eudora, then SSL is supported in the Palm VersaMail HotSync Conduit when you synchronize with that account as well.

**NOTE** You cannot use auto get mail with notification or scheduled sending retry of e-mail with accounts that use an SSL connection. See [“Auto get mail with notification”](#) and [“Send retry”](#) earlier in this chapter for information.

## Viewing the wireless coverage indicator

Your handheld contains a status indicator for determining the strength of wireless coverage in your area. You can access this indicator from within the VersaMail application by pressing Command  on any screen. Tap the wireless coverage indicator icon  for coverage status.



## Five-way navigation in the VersaMail application

The following table summarizes the controls for the five-way navigator on your handheld that are specific to the VersaMail application. See [“Using the navigator”](#) in [Chapter 3](#) for general navigator information.

View	Selection	Navigation	Function
Main List (Inbox or other folder list)	No message selected	Up/Down	Scrolls between messages in list.
		Select	Highlights the first message in the list.
		Right	No function.
	Message selected	Left	No function.
		Select	Opens messages for viewing.
		Right	Displays popup menu that normally appears when you click on the e-mail icon for each message.
Compose New Message	N/A	Left	Deselects the highlighted message.
		Up/Down	In To, cc, bcc, and Subject fields: Tabs to the next/previous field. In message body text: Scrolls the text viewed on the text list.
		Select	No function.
		Right	In To, cc, bcc, and Subject fields: Moves to the next character. In message body text: No function.
		Left	In To, cc, bcc, and Subject fields: Moves to previous character. In message body text: No function.

<b>View</b>	<b>Selection</b>	<b>Navigation</b>	<b>Function</b>
Read Message	N/A	Up/Down	Scrolls the message text.
		Select	Returns you to list view.
		Right	Displays the next message. If you are viewing the last message, returns you to the folder list view.
		Left	Displays the previous message. If you are viewing the first message in the folder, returns you to the folder list view.

When you return to the list view (Inbox or other folder) after viewing a message, the message you were viewing may or may not be selected in the list, according to the following:

- If you pressed Select to view the message, the message will be highlighted on the list when you return to the list view.
- If you used the stylus or pressed Right or Left to view the message, it will not be highlighted when you return to the list view. If you press Select, the first message in the list will be selected.

The following sample procedure shows how to use the navigator to read and delete a message.

**To read and delete a message:**

1. Press Up or Down on the navigator to scroll to the message you want to read.
2. Press Select to select the message, and then press Select again to open the message.
3. After reading the message, press Select to close the message.
4. (Optional) The cursor should remain on the selected message. If not, press Up or Down to scroll to the message, and press Select to select the message.
5. Press Right to open the pop-up menu.
6. Press Down to scroll to Delete Message.
7. Press Select to delete the message.
8. Press Select to confirm that you want to delete the message.

## Keyboard shortcuts in the VersaMail application

The following table summarizes the keyboard shortcuts specific to the VersaMail application. See [Chapter 3](#) for general keyboard shortcut information.

To use a keyboard shortcut:

1. Press Command .
2. Press the letter of the shortcut.

ShortCut	Feature
C	Copy
D	Delete
E	Empty Trash
F	Forward Message
H	Mark Read
I	Mark Unread
K	Keyboard
L	Address Lookup
M	Get Message
N	Create New Message
O	Reply to Message
P	Paste
Q	Go to Bottom
R	Preferences ...
S	Select All
T	Go to Top
U	Undo
V	Move To ...
W	Save to Draft
X	Cut
Y	Send
Z	Deselect All
Press & hold Mail	Get & Send



# Using PalmSource® Web Browser



PalmSource® Web Browser is your gateway to the web. Use Web Browser to do the following:

- Visit web pages.
- Change your home page.
- Bookmark your favorite sites.

## Using Web Browser's features

Web Browser is fast and has a number of features that make it easy to use. The browser is secure and has an informative tips that help you effectively access the web.

### Web Browser is easy to use

Web Browser is easy to use because it works much like the web browsers you use on your desktop computer. You can enter web addresses (also called URLs—Uniform Resource Locators), create bookmarks to mark favorite pages, save pages, and even download files directly to your handheld.

More importantly, Web Browser is designed to be used on the small screen of your handheld. It forces images to fit the handheld's screen; it doesn't clutter your screen with fancy icons; and it handles technical features (like plug-ins) with minimal input from you.

### Web Browser is fast

Web Browser is designed with the knowledge that you may be viewing web pages using a slow connection. Web Browser processes each web page to make the download as fast as possible, compressing the text, removing some large images, and compressing other images. In addition, Web Browser has preferences that you can adjust to make downloading even faster.

Because wireless Internet connections tend to be slower than the wired connections common on desktop computers, Web Browser also avoids downloading a web page when it can display that page from memory. Before it downloads a web page, it can check with the web server to see if the content in memory is up-to-date.

If you set the option to display web pages already in memory, you are on occasion likely to see a web page with a banner that says something like, “This content is X days old.” This banner informs you that instead of connecting to the Internet, Web Browser is displaying a page from memory. Of course, you can refresh the page anytime. You can also have Web Browser display a confirmation dialog box so that you must manually accept every connection made to the Internet.

## Web Browser is secure

Web Browser uses advanced encryption technology from RSA. Encryption makes your data unreadable by anyone but the intended recipient.

This encryption technology is used to secure the transmission of sensitive information, such as credit card numbers, e-mail messages, and passwords. Data is protected both when sent from your handheld over the network and when coming in from the Internet directly to your handheld. For more information about RSA encryption technology, visit the RSA web site: [www.rsasecurity.com](http://www.rsasecurity.com).

When a wireless transaction is secured, the command button that initiates the transaction is marked by the security icon, which looks like a key:

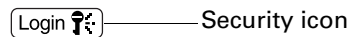

It's not unusual to experience an additional delay of several seconds when a transaction is being encrypted.

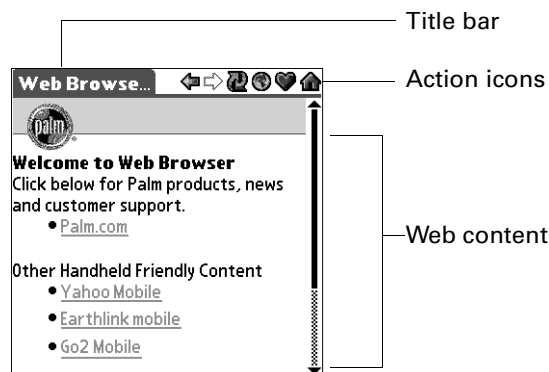

## What Web Browser looks like

When you start Web Browser for the first time, the following screen—the default home page—appears:



The Web Browser screen has three parts:

- The title bar displays the name of the current web page.
- The action icons let you navigate in the browser, refresh pages, and look at your lists of favorite pages.
- The rest of the screen is devoted to displaying the content of the web page.

You can perform other actions by tapping items in menus. Like other Palm OS® applications, when you press Function  + Menu , the title bar is replaced by the menu bar.

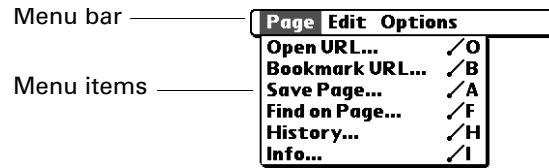

## Getting help in Web Browser

Help is available in the following locations:

- The link on the Web Browser home page.

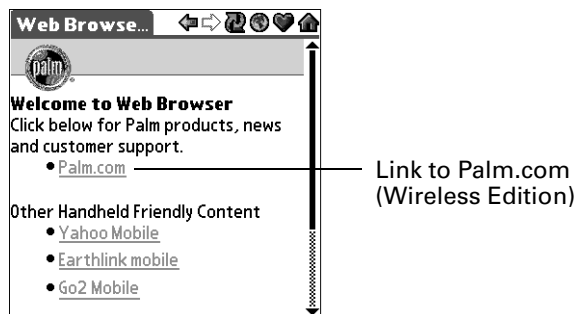

- Most dialog boxes in Web Browser have help about the options in the dialog box. To see that information, tap the Tips icon .

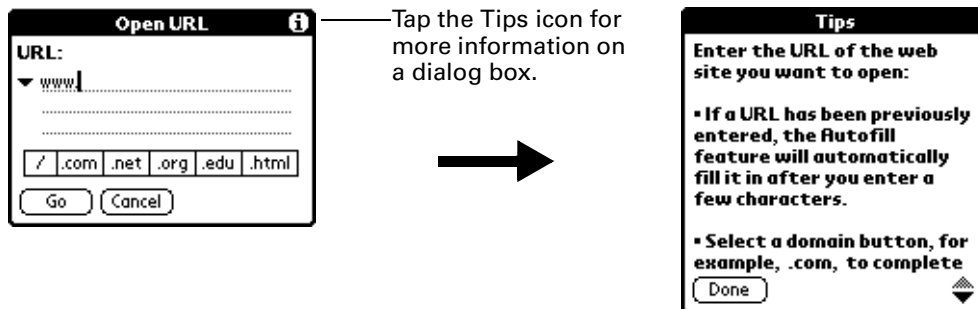



## Opening Web Browser

Web Browser can be opened using the Web button or the Web icon.

To open Web Browser:

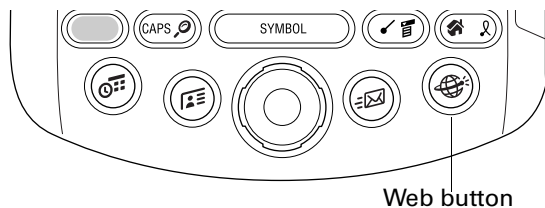
- Press the Web application button  on the front panel of your handheld. Web Browser may take a moment to load the first page.



- Press Home , and then select the Web Browser icon .

When you open Web Browser, you immediately go to the home page.



## Browsing the Web on your handheld

Just like the web browser you use on your desktop computer, Web Browser lets you browse the web in several ways:

- Visit a web page by entering its web address, also called a URL.
- Visit another web page by tapping a link.
- Go back to the pages you already visited by using the Back and Forward icons.

### Visiting a web page

To visit a web page:

1. Press Command Stroke  + O, or tap the Open URL icon .
2. Enter the URL of the web page you want to visit.

The field in the Open URL dialog box already contains the characters “www.” If the web address you want to enter starts with another set of letters, just drag over the “www.” and press the Delete key  to erase them.

Tap buttons to enter other characters commonly used in web addresses.

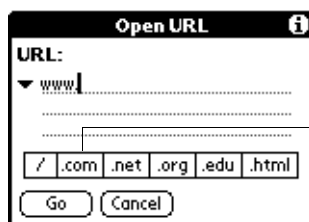

(Optional) Tap buttons to complete the web address



### 3. Tap Go.

During the short delay while the new page is downloaded, the title bar displays information about the download process.

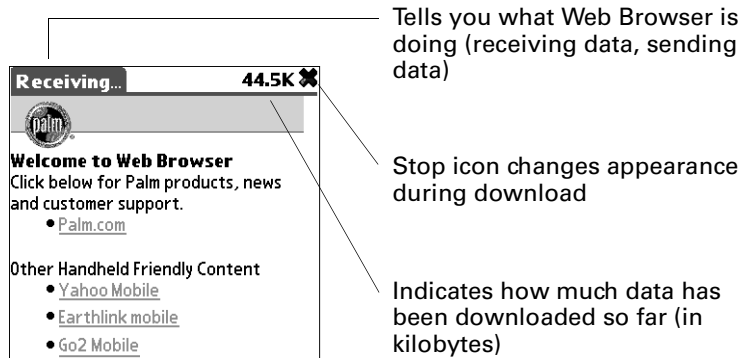

## Following a link

Many web pages contain links, which are text or pictures that when clicked, take you to another web page or to another part of the same page. Like many other web browsers, Web Browser highlights these links by underlining them.

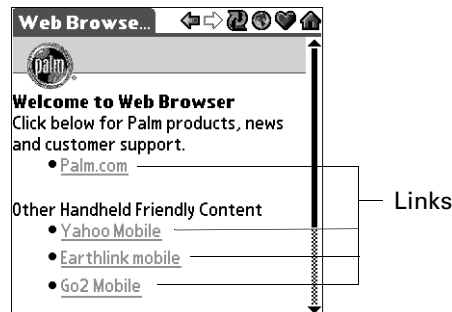

To follow a link:

- Tap the link.

## Returning to a web page you just visited

To go back to the last web page you visited:

- Tap the Back icon .

To go back to an earlier page:

- Tap the Back icon until you return to the page you want.

The list of stored pages (which is limited by your handheld's memory) is called the History list.

To go forward through the History list:

- Tap the Forward icon ➡.

## Going to your home page

Your home page is set by you in the General Preferences. See [“Changing your home page”](#) later in this chapter for information about setting the URL for your home page.

Your home page opens when you tap the Home icon 🏠 and can also be set as your starting page that displays every time you start a new browser session. See [“Changing your starting page”](#) later in this chapter for information about setting your home page as your starting page.

To go to your home page:

- Tap the Home icon 🏠.



## Downloading a file to your handheld

Web Browser can download files such as text files, word processor documents, or pictures, as well as web pages. Downloading a file is much like visiting a web page.

To download a file by following a link from a web page:

1. Tap the link.

When you download a Palm OS application (PRC) or Palm OS database (PDB), your handheld recognizes the file and installs it.

2. If a warning message appears asking you to confirm the file you want to download, and the file is the one you want, press Function  + Enter , or tap OK.



- If the file has to be handed off to another application (such as Address Book), you see a dialog box that prompts you to accept the file transfer.



The progress information in the title bar tells you how much data has been downloaded to your handheld.

If your handheld can't recognize the file type, you see an alert dialog box that tells you that the file is in an unknown format. Web Browser does not download the file.



## Stopping the download process

If you decide that the download process is taking too long, you can stop it.

To stop a page or a file from downloading:

- Tap the Stop icon .

You can make changes to improve the download speed, such as removing images from your web pages. See [“Enabling or disabling image download”](#) later in this chapter.

## Refreshing a page

Some web pages, such as news sites, change frequently. If you visit a page and spend several minutes reading an article, the web site may change during that time. To make sure you have the latest content, refresh the page.

To refresh a page:

- Tap the Refresh icon .

You can also view old content instead of accessing the Internet. (See “[Setting Connecting Preferences](#)” later in this chapter.) You can force Web Browser to download the latest content from the Internet by refreshing the page.



## Viewing information about a web page

Because of the limited space on the handheld screen, Web Browser doesn't display the current web address (URL) all the time. To find the name, size, and address of the current web page, open the Web Page Info dialog box.

To view information about the current web page:

1. Press Function + Menu .
2. Tap Info in the Page menu.



To see the entire URL, tap the box. The URL displays in the URL Viewer.

3. Press Function + Enter , or tap OK.

You can also use this method to view information about saved pages. However, the information you see might be different from the information for regular web pages.



## Bookmarking your favorite pages

When you read a printed book, you place a bookmark at the page where you stopped reading so that you can remember where you stopped. In the same way, you can bookmark a web page for later reference. A bookmark in Web Browser doesn't store the actual page; instead, it stores a reference to the page's web address (URL).



## Adding a bookmark

If you would like to visit the current page again, add a bookmark to the Bookmark list.

To add a bookmark for the current page:

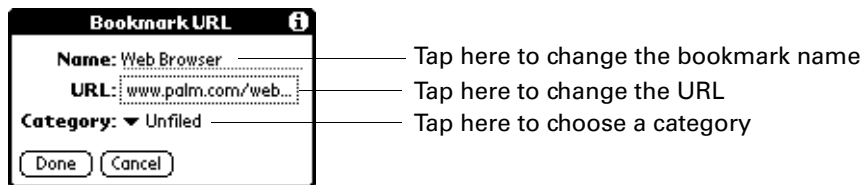
1. Press Function  + Menu .
2. Tap Bookmark URL in the Page menu.
3. (Optional) Change the bookmark name, URL, or category.



4. Press Function  + Enter , or tap Done.

You can also add a bookmark by going to the Web Content dialog box, tapping Bookmarks, and then tapping Add.

## Visiting a bookmarked page

Use your list of bookmarks to visit a particular page again.

To visit a bookmarked page:

1. Tap the Web Content icon .
2. Tap Bookmarks.
3. Tap the name of the bookmarked page you want to visit.

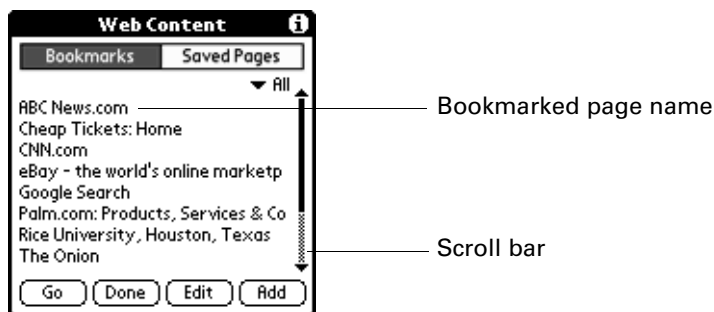

4. Tap Go.





## Editing information about a bookmark

You can edit the name and URL of a bookmark, and change its category.

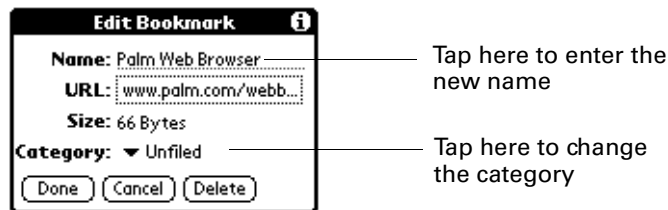
**To edit information about a bookmark:**

1. Tap the Web Content icon .
2. Tap Bookmarks.
3. Tap the name of the bookmark you want to edit.
4. Tap Edit.
5. Tap the Name field, and then enter the new name.
6. Tap the URL box to display the URL Viewer and change the address.
7. Tap the Category pick list to change the category or create a new category.





8. Press Function  + Enter , or tap Done to return to the Web Content dialog box.
9. Press Function  + Enter , or tap Done.

## Deleting a bookmark

You can delete bookmarks that you no longer want.

**To delete a bookmark:**

1. Tap the Web Content icon .
2. Tap Bookmarks.
3. Tap the name of the bookmarked page you want to delete.
4. Tap Edit.
5. Tap Delete.
 

A confirmation dialog box appears.
6. Tap Delete.
7. Press Function  + Enter , or tap Done.



## Saving pages

Although Web Browser keeps a History list of all the pages you visited recently, it doesn't keep items in the list indefinitely. If you want to save a page (such as a travel itinerary or Internet order receipt) indefinitely, create a saved page. A saved page is a copy of the page. The copy is stored on the handheld until you delete it.

### Saving a page

You can also save a page by going to the Web Content dialog box, tapping Saved Pages, and then tapping Save.

**To save a web page:**

1. Press Command Stroke  + A.  
Alternately, press Function  + Menu , and select Save Page on the Page menu.
2. (Optional) Change the page name or category.
3. Tap Save.

The page displays an S in the title bar indicating the page is saved.

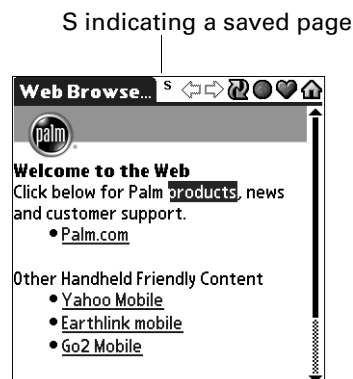

### Opening a saved page

When you open a saved page, remember that you're only seeing a copy of the actual page. To view the current version of the web page, enter the web address again.

**To open a saved page:**

1. Tap the Web Content icon .
2. Tap Saved Pages.

3. Tap the name of the saved page you want to open.

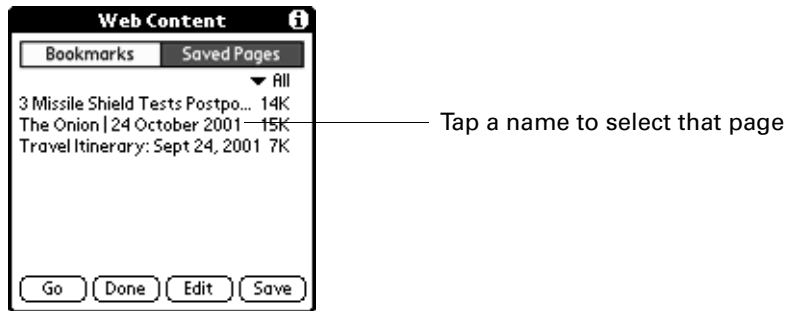

4. Tap Go.





## Editing information about a saved page

You can edit the name of a saved page and change its category.

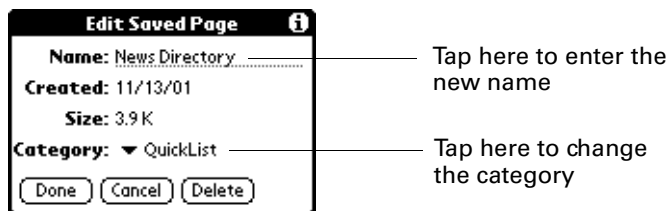
To edit information about a saved page:

1. Tap the Web Content icon .
2. Tap Saved Pages.
3. Tap the name of the saved page you want to open.
4. Tap Edit.
5. Tap the Name field, and then enter the new name.
6. Tap the Category pick list to change the category or create a new category.





7. Press Function  + Enter , or tap Done to return to the Web Content dialog box.
8. Press Function  + Enter , or tap Done.



## Copying text from a page to another application

To copy the text of a web page into another application, use Copy Page. Copy Page doesn't copy images, only text.

To copy text from a page:

1. Press Function  + Menu .
2. Tap Edit, and then select Copy Page.



You can then paste the copied page into another application, such as Memo Pad.

## Deleting a saved page

To delete a saved page:

1. Tap the Web Content icon .
2. Tap Saved Pages.
3. Tap the name of the saved page you want to delete.
4. Tap Edit.
5. Tap Delete.

A confirmation dialog box appears.

6. Tap Delete.
7. Press Function  + Enter , or tap Done.

## Searching for text on a page

You can search for text on a web page.

To search for text on a web page:

1. Press Command Stroke  + F.

Alternately, press Function , and select Find on page on the Page menu.

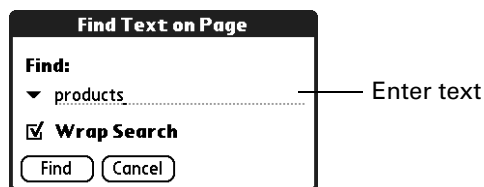

2. Enter text and tap find.  
Text is highlighted.





## Finding web pages you recently visited

Using the Back and Forward icons to browse through the pages you recently visited, one page at a time, can be tedious. Instead, use the History list to view a list of the pages you visited and go directly to any page in that list. The History list contains a record of all of the pages you visited recently, up to the limit you set in Web Preferences.

### Returning to a page you visited

To return to a page you visited:

1. Press Function  + Menu .
2. Tap History in the Page menu.
3. Tap the name of the web page you want to visit.

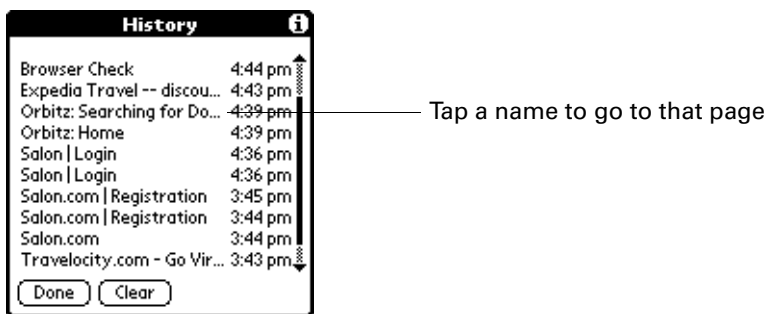

## Using Web Preferences

Web Preferences enables you to customize your Web Browser options to improve the speed, ease of use, and security of your browsing experience. The options are grouped into three categories: General, Connecting, and Privacy. Each category provides access to a list of relevant Preferences screens.

## Setting General Preferences

The General Preferences options enable you to customize your home page, starting page, what is loaded, and your History List memory. This section provides details about each of these preferences.

### Changing your home page

You can change your home page to any web address. Your home page opens when you tap the Home icon .



To change your home page:

1. Press Command Stroke  + R.

Alternately, press Function  + Menu , and select Preferences on the Option menu.

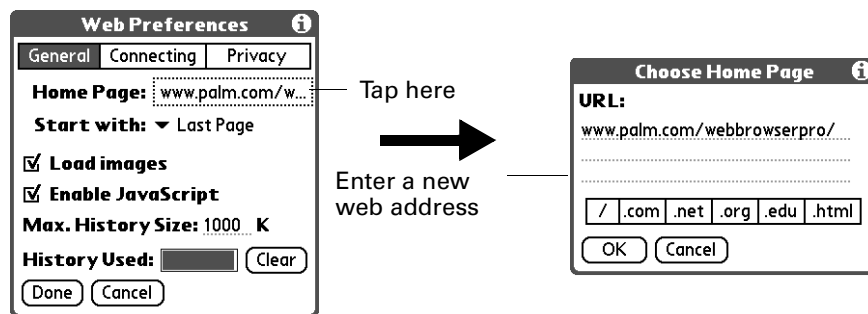
2. Tap the Home Page field.
3. Enter the address of the new home page.



4. Press Function  + Enter , or tap Done.

### Changing your starting page

Your starting page is the web page that displays when you first open Web Browser. You can set your start page to either the last page you were browsing or your home page.



To change your starting page:

1. Press Command Stroke  + R.

Alternately, press Function  + Menu , and select Preferences on the Option menu.

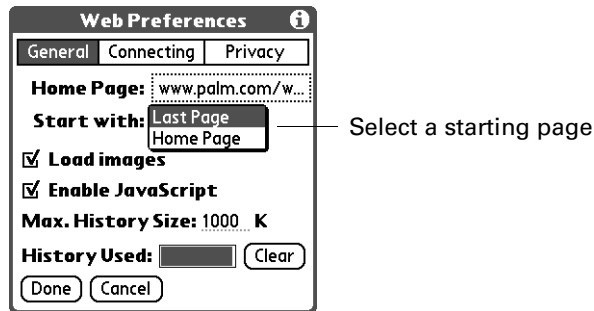
2. Tap the Start with pick list and select either Last Page or Home Page.





3. Press Function  + Enter , or tap Done.



### Enabling or disabling image download

Images in web pages can be very large. You can make web pages download faster by removing images.

To enable or disable images download:

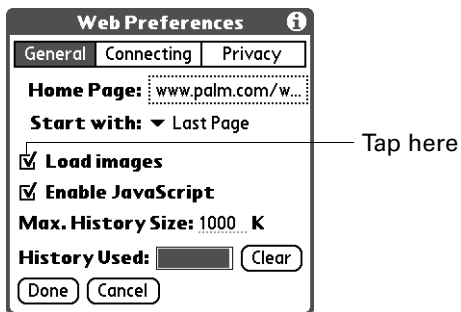
1. Press Command Stroke  + R.  
Alternately, press Function  + Menu , and select Preferences on the Option menu.
2. Select or deselect the Load images check box.  
When the box is checked, images will be downloaded.





3. Press Function  + Enter , or tap Done.

### Enabling or disabling JavaScript



You can change how web pages download by disabling the JavaScript.

To enable or disable JavaScript:

1. Press Command Stroke  + R.  
Alternately, press Function  + Menu , and select Preferences on the Option menu.

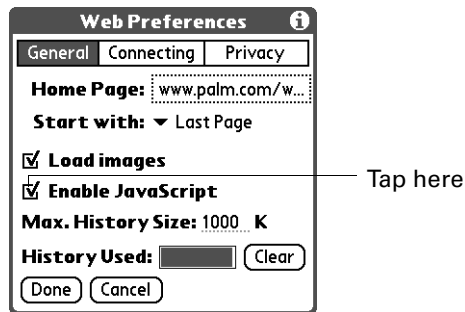
2. Select or deselect the Enable JavaScript check box.  
When the box is checked, JavaScript is enabled.





3. Press Function  + Enter , or tap Done.

### Changing the size of the History list cache memory



Storing pages in the History List enables you to retrieve pages quickly without downloading. Because memory on your handheld is often limited, you can adjust the size of your History list cache memory to match your needs.

To change the size of the History list:

1. Press Command Stroke  + R.  
Alternately, press Function  + Menu , and select Preferences on the Option menu.
2. In the Max. History Size field, enter a new maximum size, in kilobytes.

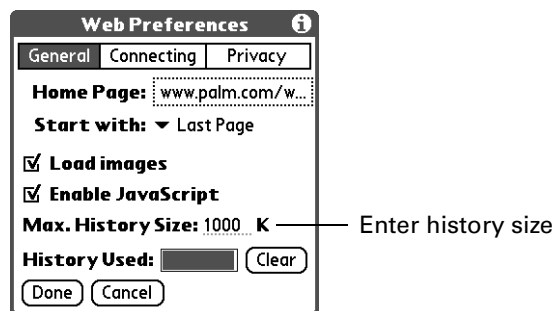
**NOTE** Remember that you have a limited amount of memory. Choose a History list size that lets you store at least a few pages but still leaves room on your handheld for other data and applications.



3. Press Function  + Enter , or tap Done.

### Clearing the History list cache memory

You can view the amount of History List memory used from the History Used bar. You can manually clear your History list memory to make sure you are getting current pages downloaded or to free up memory.

---

**IMPORTANT** Clearing the History list removes all record of your recent browsing history. If you need to remember the location of a page you recently visited, create a bookmark or a saved page for that page before clearing the History list.

---

To clear the History list:



1. Press Command Stroke  + R.

Alternately, press Function  + Menu , and select Preferences on the Option menu.

2. Tap Clear.

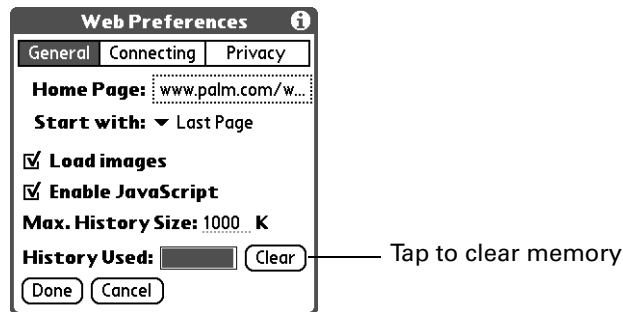
**NOTE** This action only clears the contents of the History list. Your bookmarks and saved pages are not deleted.



3. Press Function  + Enter , or tap Done.

## Setting Connecting Preferences

The Connecting Preferences options enable you to customize your connection. This section provides details about each of these preferences.

Because some wireless Internet service providers (ISPs) charge by the amount of data you download, Web Browser enables you to limit how often it accesses the Internet. If you have a slower or more expensive Internet connection, you can prevent Web Browser from accessing the Internet unless you approve.

To change your Connecting Preferences:

1. Press Command Stroke  + R.

Alternately, press Function  + Menu , and select Preferences on the Option menu.

2. Tap Connecting.

3. Change the options.

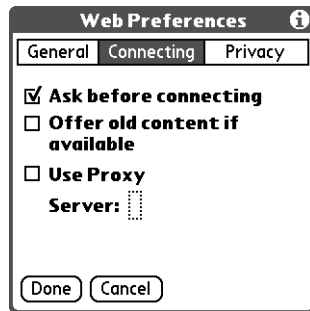

**Ask before connecting**



You are notified before Web Browser accesses the Internet.

**Offer old content if available**

Web Browser displays old pages from its History list instead of retrieving pages from the Internet, even if the old pages are outdated.

**Use Proxy Server**

Enables to designate a proxy server.

4. Press Function  + Enter , or tap Done.

## Setting Privacy Preferences

The Privacy Preferences options enable you to automatically fill out forms and enable or disable cookies. This section provides details about each of these preferences.

### Enabling or disabling autofill

Filling out an order form or application on the web usually requires entering several pieces of information: your name, address, phone number, and so on. By default, Web Browser stores the information you entered in these fields. The next time you use that order form and type in the first few letters in a field, Web Browser remembers the last item you entered in that field that started with those letters, and fills in the field.

#### To enable or disable autofill:



1. Press Command Stroke  + R.

Alternately, press Function  + Menu , and select Preferences on the Option menu.

2. Tap Privacy.

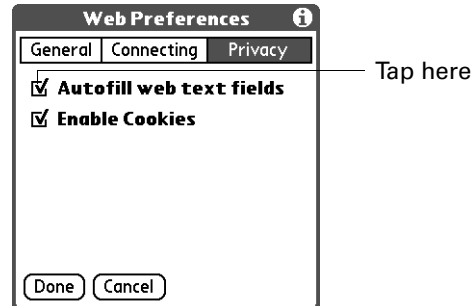
3. In the Autofill text fields check box, do one of the following:
  - To turn off autofill, tap to remove the checkmark.
  - To turn on autofill, tap to select it.



4. Press Function  + Enter , or tap Done.



### Enabling or disabling cookies

Some web sites store information in a small text file, called a “cookie.” Cookies usually contain information about you and your preferences for that web site. A site can use this information to customize the pages you see the next time you visit.

Allowing a web site to create a cookie does not give the site access to the rest of your handheld. A cookie only stores the information you provide while visiting the web site.

By default, Web Browser saves the cookies it receives. You can tell it not to accept cookies.



#### To enable or disable cookies:

1. Press Command Stroke  + R.  
 Alternately, press Function  + Menu , and select Preferences on the Option menu.
2. Tap Privacy.

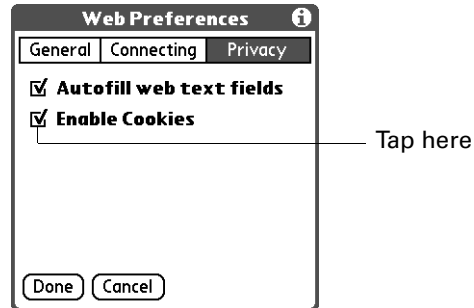

3. In the Enable cookies check box, do one of the following:
  - To prevent Web Browser from storing cookies, tap to remove the checkmark.
  - To accept cookies, tap to select it.





- Press Function  + Enter , or tap Done.

## Finding the Web Browser version number

Web Browser may use specialized Palm OS applications to help it display web content. Some of these applications may only be compatible with a particular version of Web Browser.

To find the Web Browser version number:

1. Press Function  + Menu .
2. Select About Web Browser under the Options menu

## Web Browser menus

Web Browser menus are shown here for your reference, and Web Browser features that are not explained elsewhere in this book are described here.

See “Using menus” in [Chapter 4](#) for information about choosing menu commands.

## Page menu

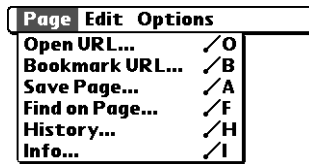

- Bookmark URL**      Bookmarks the current page.
- History**            Opens the History list, where you can view the sites you most recently accessed.
- Info**                Opens the Web Page Info dialog box, enabling you to view the name, URL, and size of the current web page.

## Options menu

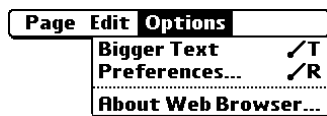

- Bigger Text / Smaller Text**      Increases or reduces the size of the screen text.
- About Web Browser**      Shows version information about Web Browser.

# Using World Clock

 World Clock enables you to view the current time and date in multiple locations and to set an alarm. Use World Clock to do the following:

- View the current time and date in three locations.
- Open a preferences screen where you can set the time and date for all the applications on your handheld.
- Set an alarm.
- Set Daylight Saving options.

To open World Clock and view the time:

1. Press Home .
2. Select the World Clock icon .

**TIP** Press Select on the navigator, and then tap Go to Clock.



## Setting the primary location

You can use World Clock to select the location and date and time for the primary location. Keep in mind that the primary Location settings are system date and time and that these settings are used by all the applications on your handheld. The primary Location settings also appear in the Date & Time Preferences screen. Similarly, if you change the settings in the Date & Time Preferences screen, those settings become your system date and time and also appear under the primary Location in World Clock. The primary Location settings also serve as a point of reference for the secondary locations.

The following procedures show you how to set the Location and Date & Time from within World Clock. See [“Date and Time preferences”](#) in [Chapter 18](#) for details on setting these preferences.

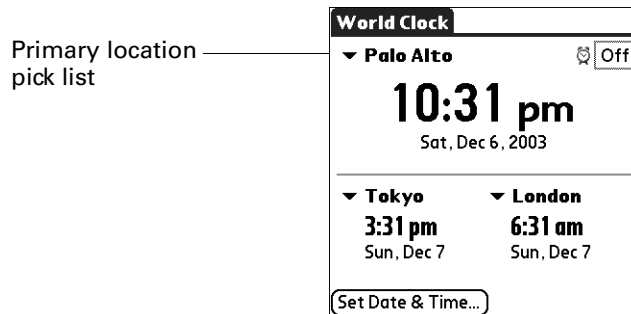

#### To set the location:

1. Tap the primary location pick list.



2. Tap the location you want to use as the primary location.



The location you select is typically a large city in the same time zone as the one where you live. If an appropriate choice does not appear in the list, see [“Adding a location”](#) later in this chapter to create a new location.

3. Press Function  + Enter , or tap OK.

#### To set the date:

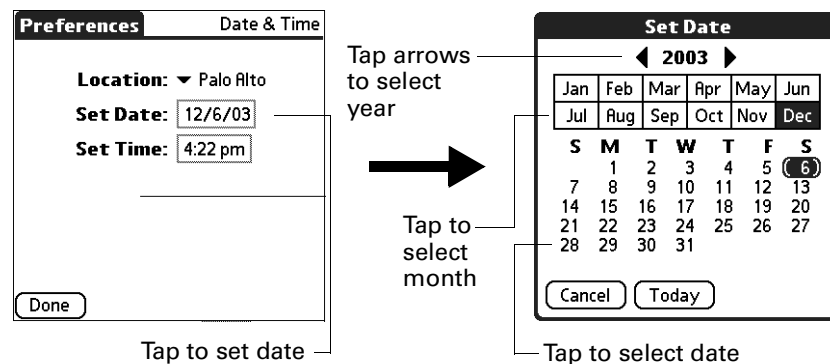
1. Tap Set Date & Time.
2. Tap the Set Date box.
3. Tap the arrows or press Right and Left on the navigator to select the current year.





4. Tap the current month.
5. Tap the current date.
6. Press Function  + Enter , or tap Done.

To set the time:

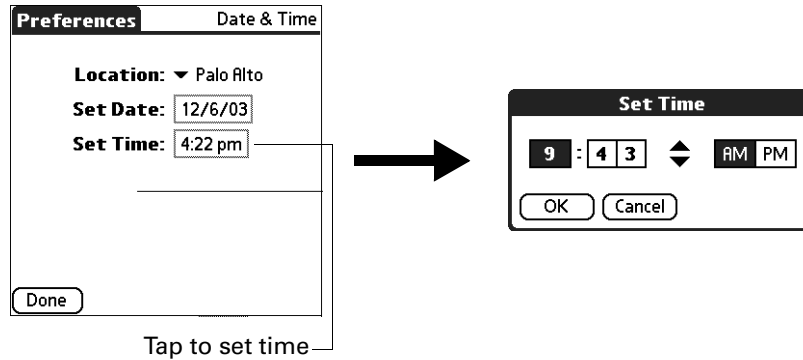
1. Tap Set Date & Time.
2. Tap the Set Time box.



3. Tap the up or down arrows to change the hour.
4. Tap each number of the minute, and then tap the arrows to change them.
5. Press Function  + Enter , or tap OK.
6. Press Function  + Enter , or tap Done.

## Choosing a different primary location

If you travel to another location and you want alerts to appear based on local time, you need to change the primary location to update the system time. You may, however, prefer to use the secondary locations to view the local date and time, and leave the primary location set to your home location.

To change the primary location:

1. Tap the pick list next to the current primary location.

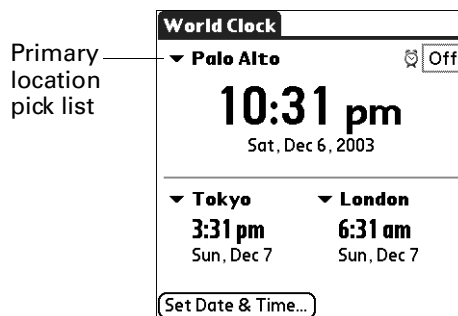

2. Select the location you want to use as the new primary location.

If the new location is in another time zone, World Clock automatically updates the date and time in all the applications on your handheld.

## Setting the secondary locations

The secondary locations display the date and time in two locations other than the primary location. You can use the secondary locations to view the time in places to which you travel or you need to contact people.

The date and time in the secondary locations are based on the Date & Time in the primary location.

To select the secondary locations:

1. Tap the pick list next to the secondary location.

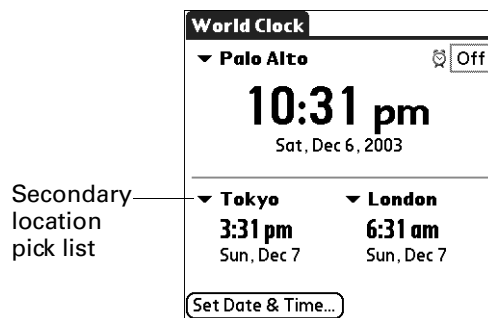



2. Select the location you want to use as the new secondary location.

If an appropriate location does not appear in the list, see the next section, [“Adding a location,”](#) to create a new location.

## Adding a location

If an appropriate location does not appear in the Location pick list, you can add a new location to the list, and if necessary adjust the time zone and Daylight Saving settings. If you activate the Daylight Saving options, the time change automatically occurs at 1:00 AM on the selected start and end dates.

To add a location:

1. Tap the Location pick list.
2. Select Edit List.
3. Tap Add.
4. Select a location that is in the same time zone as the city you want to add.
5. Press Function  + Enter , or tap OK.
6. (Optional) Tap the Name field and modify the Location name.

- (Optional) Tap the Time Zone box and select a time zone.

**Edit Location**

Name: Palo Alto



Time Zone: USA (Pacific)

This location observes Daylight Saving Time

Start: First Sunday of April

End: Last Sunday of October

OK Cancel

- Press Function  + Enter , or tap OK.
- Press Function  + Enter , or tap Done.

#### To set Daylight Saving options:

- From the Edit Location dialog box, tap the This location observes Daylight Saving Time check box to select it.
- Tap the Start box.

**Set Start Date**



Jan	Feb	Mar	Apr	May	Jun
Jul	Aug	Sep	Oct	Nov	Dec

Week: ▼ First

Day: ▼ Sunday

First Sunday of April





OK Cancel

- Tap the month when daylight saving begins.
- Tap the Week pick list.
- Select the week when daylight saving begins within the selected month.
- Tap the Day pick list.
- Select the day of the week when daylight saving begins within the selected week.
- Press Function  + Enter , or tap OK.
- Tap the End box and repeat steps 3 through 8 to select when daylight saving ends.
- Press Function  + Enter , or tap OK.

## Modifying a Location

If you add a location and later realize you did not use the correct settings, you can modify the location.





**To modify a Location:**

1. Tap a Location pick list.
2. Select Edit List.
3. Select the location you want to modify.
4. Tap Edit.
5. Adjust the settings. See [“Adding a location”](#) earlier in this chapter for details.
6. Press Function  + Enter , or tap OK.
7. Press Function  + Enter , or tap Done.

## Removing a location

If you no longer need a location that appears on the Location list, you can remove it from the list. You cannot remove a location that is currently assigned to the primary location.

**To remove a Location:**

1. Tap a Location pick list.
2. Select Edit List.
3. Select the location you want to remove.
4. Tap Remove.
5. Press Function  + Enter , or tap OK to confirm the deletion.
6. Press Function  + Enter , or tap Done.







## Setting an alarm

In addition to setting and displaying the Date & Time, World Clock also provides a convenient travel alarm feature. You can set an alarm to sound during the next 24-hour period.

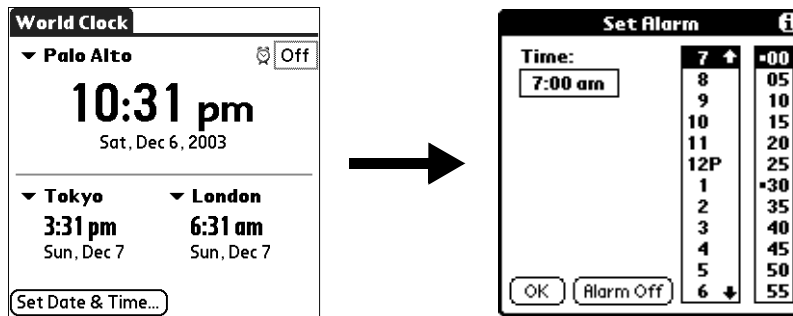
To set an alarm:

1. Tap the box next to the Alarm icon  to open the Set Alarm dialog box.



2. Tap the time columns to set the hour and minute.
3. Press Function  + Enter , or tap OK.
4. When the alarm reminder message appears, do one of the following:
  - Press Function  + Enter , or tap OK to permanently dismiss the reminder and return to the current screen.
  - Tap Snooze to dismiss the reminder and return to the current screen. An attention indicator blinks in the upper-left corner of the screen to remind you of the pending alarm, and the reminder message appears again in five minutes. When the reminder message reappears, the current time is displayed in the Reminder bar and the alarm time appears on the screen.
  - Tap Go To to open World Clock and dismiss the alarm.

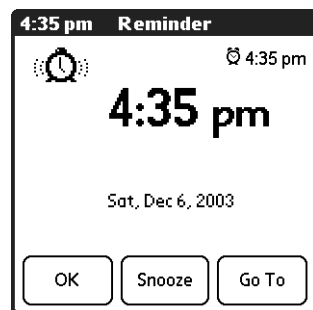

## Using World Clock menus

World Clock menus are shown here for your reference, and World Clock features that are not explained elsewhere in this book are described here.

See “Using menus” in [Chapter 4](#) for information about choosing menu commands.

### Options menu

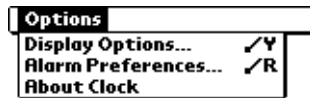

**Display Options** Opens a dialog box where you can choose which information appears on the World Clock screen.

**Show Multiple Locations.** Activates the secondary location displays. When it is selected, the secondary locations appear below the primary location.

**Show Date.** Activates the date display. When it is selected, the date appears below the time for each location.

### Alarm Preferences

**Sound.** Sets the sound of the alarm. The choices are Alarm, Bumble Bee, Reveille, Sonata, Wake Up, and Warbler.

**Volume.** Defines how loud the alarm sounds. The choices are Low, Medium, and High.

### About World Clock

Shows version information for World Clock.

# Performing HotSync® Operations

HotSync® technology enables you to synchronize data between one or more Palm OS® handhelds and Palm™ Desktop software or another PIM such as Microsoft Outlook. To synchronize data, you must connect your handheld and Palm Desktop software. You can then either place your handheld in the cradle/cable attached to your computer or use your wireless local area network (LAN) to synchronize data. You can also use infrared communications or a modem.

## Selecting HotSync setup options

You can choose when you want HotSync Manager to run. If necessary, you can adjust the local and modem HotSync settings as well.

**To set the HotSync options on a Windows computer:**

1. Click the HotSync icon  in the Windows system tray.
2. Select Setup.

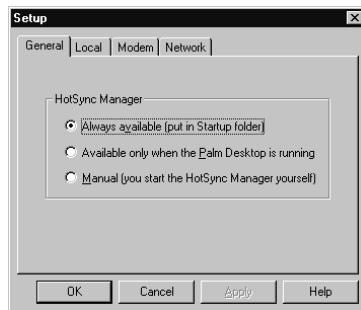

- Click the General tab and select one of the following options:

- |   |  |
|---|--|
| <b>Always available</b>                                     | Adds HotSync Manager to the Startup folder and constantly monitors the communication port for synchronization requests from your handheld. With this option, the HotSync Manager synchronizes data even when Palm Desktop software is not running. |
| <b>Available only when Palm Desktop software is running</b> | Starts HotSync Manager and monitors requests automatically when you open Palm Desktop software.  |
| <b>Manual</b>   | Monitors requests only when you select HotSync Manager from the Start menu.  |

If you're not sure which option to use, keep the default setting: Always available.

- If you are using a serial cradle/cable, click the Local tab to display the settings for the connection between your computer and the handheld cradle/cable, and adjust the following options as needed.

If you are using the USB cradle/cable, you do not need to use the settings on the Local tab for a direct HotSync operation.

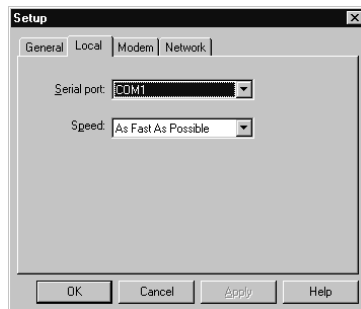

- |                    |  |
|--------------------|--|
| <b>Serial Port</b> | Identifies the port that HotSync Manager uses to communicate with the cradle/cable. You can change the port selection. |
|--------------------|--|

Your handheld cannot share this port with an internal modem or other device.

- |              |   |
|--------------|---|
| <b>Speed</b> | Determines the speed at which data is transferred between your handheld and Palm Desktop software. Try the As Fast As Possible rate first, and adjust downward if you experience problems. This setting allows Palm Desktop software and your handheld to find and use the fastest speed. |
|--------------|---|

- Click the Modem tab to display the modem settings and adjust the options as needed. See [“Using File Link”](#) later in this chapter for more information.

6. If you are attached to a network, click the Network tab to display the network settings and adjust the options as needed. For more information, see [“Conducting network HotSync operations”](#) later in this chapter.
7. Click OK.

**To set the HotSync options on Mac computers:**

1. Double-click the HotSync Manager icon  in the Palm folder.
2. Click the HotSync Controls tab and select any of the following options.

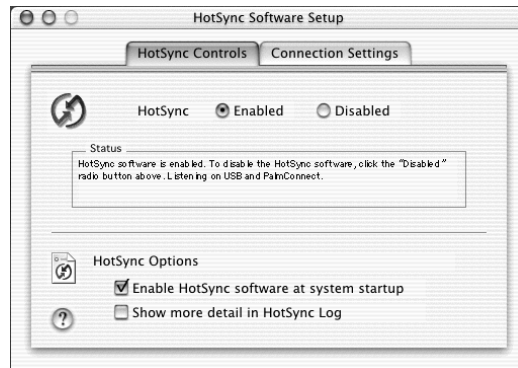

Shown with  
Mac OS X

**HotSync  
Enabled/  
Disabled**

Activates the HotSync software and prepares your computer to synchronize with your handheld. By default, the transport monitor is enabled whenever you start your computer.

**Enable HotSync  
software at  
system startup**

Activates the transport monitor automatically each time you start your computer. If this option is not selected, you must open HotSync Manager and select the Enabled option before you can perform a HotSync operation.

**Show more detail  
in HotSync Log**

Includes more troubleshooting information in the log that is generated when you perform a HotSync operation.

3. If you are using the USB cradle/cable, you do not need to adjust the settings on the Connection Settings tab for a direct HotSync operation; they are set automatically when you perform the first HotSync operation.
4. Close the HotSync Software Setup window.

## Customizing HotSync application settings

For each application, you can define a set of options that determine how records are handled during synchronization. These options are called a *conduit*. By default, a HotSync operation synchronizes all files between the handheld and Palm Desktop software.

In general, you should leave the settings to synchronize all files. The only reason you might want to change these settings is to overwrite data on either your

handheld or Palm Desktop software, or to avoid synchronizing a particular type of file because you don't use it.

In addition to the conduits for Date Book, Address Book, To Do List, Memo Pad, Note Pad, and Palm™ Photos, Palm Desktop software includes System and Install conduits, as well as conduits for the VersaMail™ application. The System conduit backs up the system information stored on your handheld, including ShortCuts. The Install conduit installs add-on applications on your handheld. The conduit for the VersaMail application enables you to select e-mail accounts to synchronize. The VersaMail application is optional and is not installed on all handhelds.

**To customize HotSync application settings on a Windows computer:**

1. Click the HotSync icon  in the Windows system tray (lower-right corner of the taskbar).

You can also click the HotSync command on the Palm Desktop software menu bar.

2. From the HotSync Manager menu, choose Custom.
3. Select the appropriate username from the list.
4. Select an application in the Conduit list.
5. Click Change.

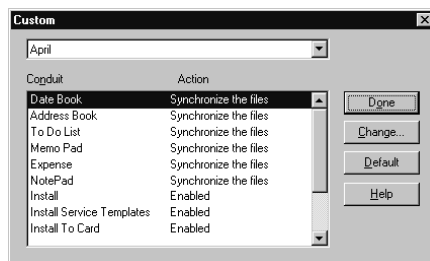

6. For each application, click the direction in which you want to write data, or click Do Nothing to skip data transfer for an application.

Changing the HotSync setting from the default affects only the *next* HotSync operation. Thereafter, the HotSync Actions revert to their default settings. To use a new setting on an ongoing basis, select the Set As Default box. Thereafter, whatever you selected as the default setting is used when you click the Default button in the Custom dialog box.

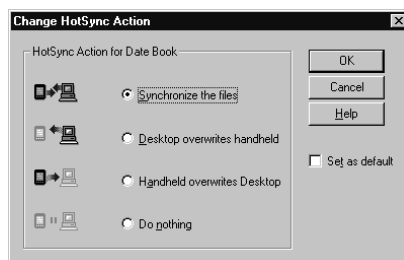

7. Click OK.
8. Click Done to activate your settings.

**To customize HotSync application settings on a Mac computer:**

1. Double-click the Palm Desktop icon in the Palm folder.
2. From the HotSync menu, choose Conduit Settings.
3. From the User pop-up menu, select the appropriate username.
4. Select an application in the Conduit list.
5. Click Conduit Settings.

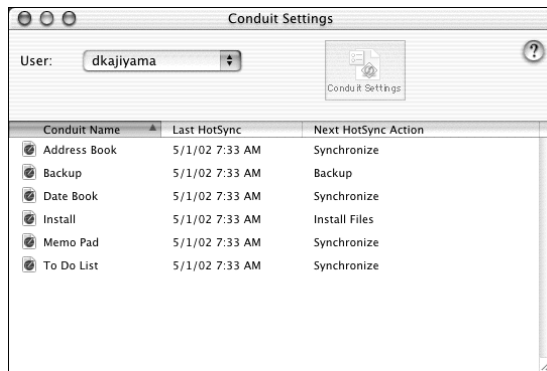

Shown with  
Mac OS X

6. For each application, click the direction in which you want to write data, or click Do Nothing to skip data transfer for an application.

Changing the HotSync setting from the default affects only the *next* HotSync operation. Thereafter, the HotSync Actions revert to their default settings. To use a new setting on an ongoing basis, click Make Default. Thereafter, whatever you selected as the default setting is used for HotSync operations.

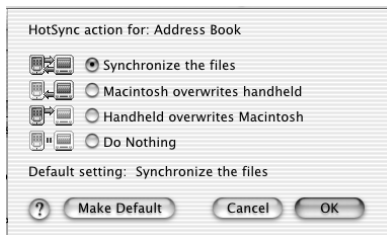

Shown with  
Mac OS X

7. Click OK.
8. Close the Conduit Settings window.

## Conducting network HotSync operations

When you use the network HotSync technology, you can take advantage of the wireless LAN connectivity available in many environments. Network HotSync technology enables you to perform a network HotSync operation using an 802.11b radio.

### Connecting to your computer through a wireless LAN

A network HotSync operation requires the following (consult your system administrator for assistance):

- Your computer has TCP/IP support installed.
- Your computer is available on a broadband network, such as a company network or DSL.

---

**IMPORTANT** Dial-up modem connection is not supported.

---

To prepare your computer for a network HotSync operation:

1. Click the HotSync Manager icon  in the Windows system tray.
2. From the HotSync Manager menu, verify that Network is selected. If Network is selected, there is a checkmark next to it. If Network is not selected, click Network to select it.

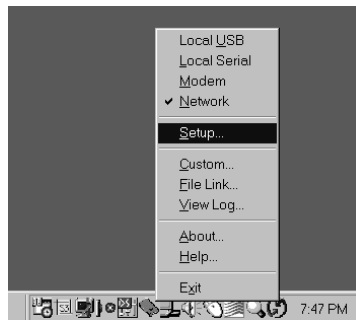

3. From the HotSync Manager menu, select Setup.
4. Click the Network tab and make sure your username has a checkmark next to it. If the checkmark is not there, click the check box next to your username.



5. If your username does not appear, click New, enter your username, and click OK.

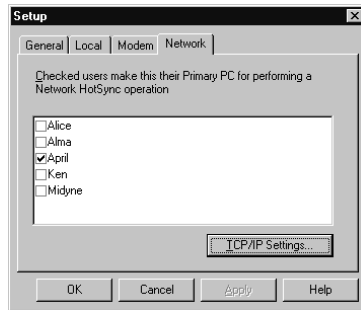

6. Click OK again.
7. Perform one of the following:
  - Put your handheld in the cradle/cable, and perform a HotSync operation. The HotSync operation records network information about your computer on your handheld. With this information, your handheld can locate your computer when you perform a HotSync operation over the network. You are ready to perform a network HotSync operation.
  - Perform a wireless network HotSync operation. You will need to go through a setup procedure on your handheld. See the next section [“Performing a wireless network HotSync operation”](#).

## Performing a wireless network HotSync operation

After you prepare your computer and select your Conduit Setup options, you are ready to perform a wireless network HotSync operation.

---

**IMPORTANT** You must install the Palm Desktop software that came with your Palm™ Tungsten™ C handheld before you attempt a network HotSync operation. Your computer must have the software installed to communicate with your handheld.

---



---

**IMPORTANT** Make sure your computer is on before performing a wireless HotSync operation.

---

### Performing a wireless HotSync operation

If you already performed a cradle/cable HotSync operation, you are ready for network HotSync operation with no further preparation needed.

**To perform a wireless network HotSync operation:**

1. Press Home .
2. Tap the HotSync icon .
3. Tap Network, and then tap the HotSync icon.

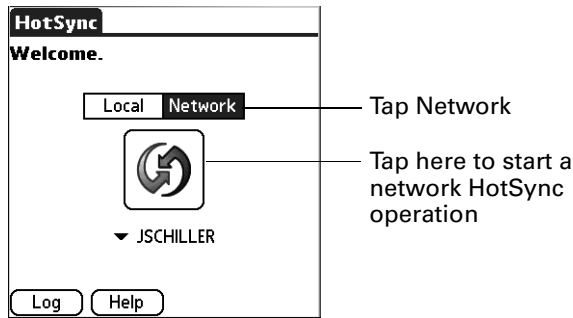



**Setting up your handheld during the first HotSync operation**

If you did not perform a cradle/cable HotSync operation, you must set up your network connection from your handheld.

You may need to manually add or change your network HotSync PC if it doesn't appear on the list of available PCs.

**To set up your handheld during the first HotSync operation:**

1. Press Home .
2. Tap the HotSync icon .
3. Tap Network, and then tap the HotSync icon.

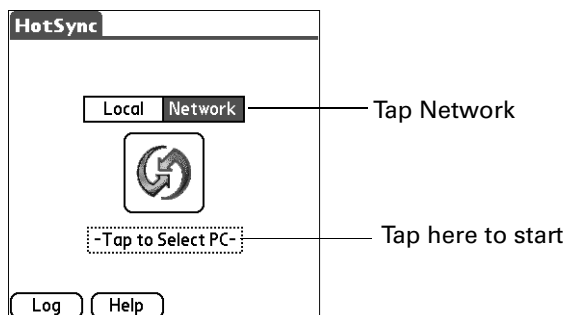

4. Tap Next.

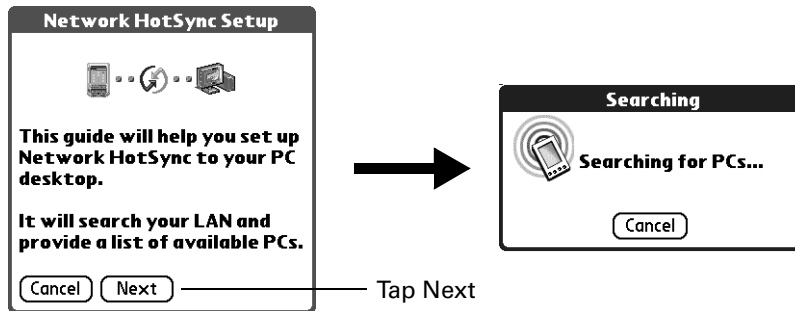

5. Perform one of the following:

- If your PCs was found on your wireless LAN, select your PC and tap next. Tap Done and you are ready to perform a HotSync operation.

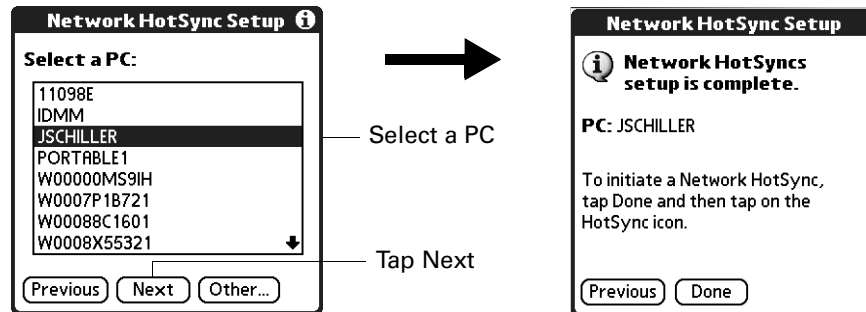

- If your PC was not found, you will need to manually add your PC using your IP address or the name of your PC. Go to the next step.

6. Tap Other.

If no PCs were found on your wireless LAN or if PCs were found, but your PC was not listed, you can add your PC.

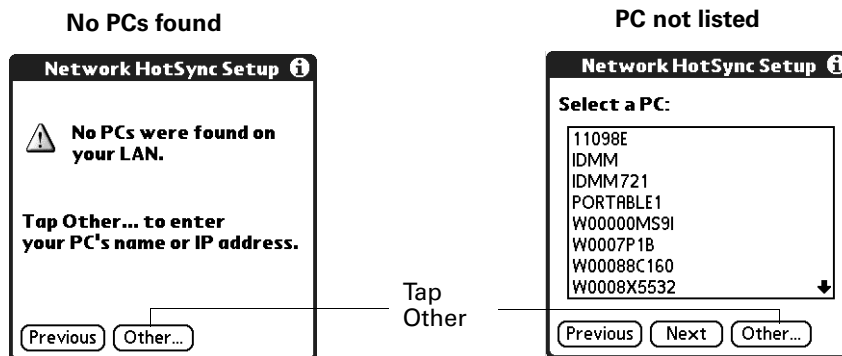

7. Enter the PC name or IP address for your PC and tap Next.

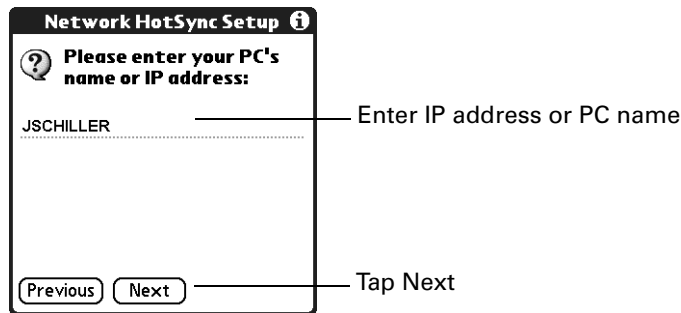

8. Tap Done.

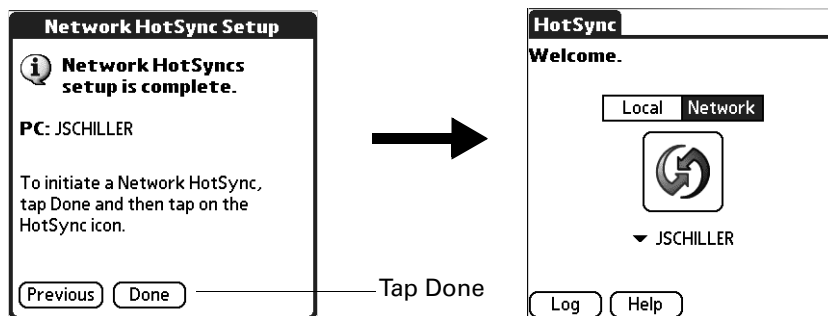

## Performing cradle/cable HotSync operations

The simplest way to synchronize data is to perform a direct HotSync operation by placing your handheld in the cradle/cable and pressing the HotSync button.

### Performing a cradle/cable HotSync operation: Windows computer

The first time you synchronize your data, you need to enter user information on Palm Desktop software. After you enter this information and synchronize, the HotSync Manager recognizes your handheld and doesn't ask for this information again.

If you are a system administrator preparing several handhelds for a group of users, you may want to create a user profile. See [“Creating a user profile”](#) later in this chapter before performing the following steps.

---

**IMPORTANT** You must perform your *first* HotSync operation with a local, direct connection, or with infrared communication, rather than using a modem or network.

---

The following steps assume that you have already installed Palm Desktop software. If you have not installed this software, see the *Palm™ Tungsten™ C Read This First* installation guide for instructions.

To perform a local HotSync operation on a Windows computer:

1. Place your handheld in the cradle/cable.

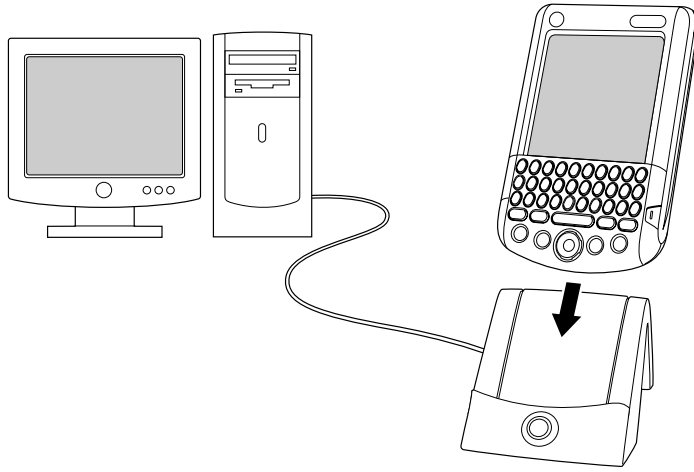

2. If the HotSync Manager is not running, start it: On the Windows desktop, click Start, and then choose Programs. Navigate to the Palm Desktop software program group and choose HotSync Manager. Alternatively, you can start the Palm Desktop software, which automatically opens the HotSync Manager.
3. Press the HotSync button  on the cradle/cable.

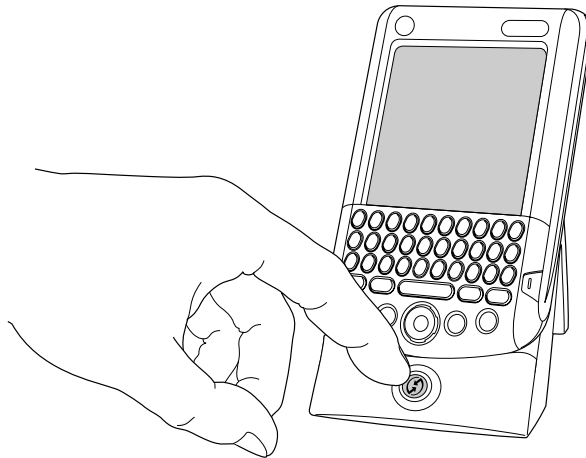

---

**IMPORTANT** The first time you perform a HotSync operation, you must enter a username in the New User dialog box and click OK. Every handheld should have a unique name. To prevent loss of a user's records, never try to synchronize more than one handheld to the same username.

---

The HotSync Progress dialog box appears and synchronization begins.

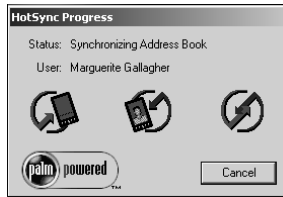

4. Wait for a message on your handheld indicating that the process is complete.

After the HotSync process is complete, you can remove your handheld from the cradle/cable. Gently tilt your handheld forward in the cradle, and then lift it up to remove it.

## Performing a direct HotSync operation: Mac computer

When you installed Palm Desktop software, you entered a username. This username is the connection between your handheld and your computer.

The first time you perform a HotSync operation the Palm Desktop software does the following:

- Adds a username to your handheld.
- Creates a folder for the username in the Users folder inside the Palm folder inside the current Mac user's Documents folder. For example, if you entered Jane Garcia as your username, a folder called Jane Garcia is created in the Users folder.

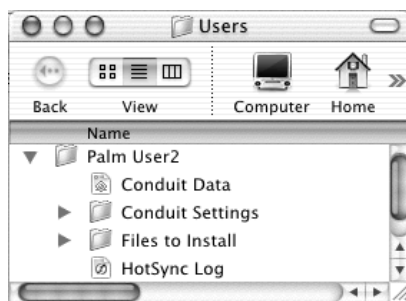

Shown with  
Mac OS X

- Creates a file named User Data in your username folder.

Usernames appear in the User pop-up on the right side of the toolbar. You can change users by selecting a new name in the pop-up menu.

Each subsequent time you perform a HotSync operation, HotSync Manager reads the username from your handheld and synchronizes the data in the folder of the same name.

Be sure you select the correct username from the User pop-up before entering data on Palm Desktop or performing a HotSync operation.

If you are a system administrator preparing several handhelds for a group of users, you may want to create a user profile. See [“Creating a user profile”](#) later in this chapter before performing the following steps.

---

**IMPORTANT** You must perform your *first* HotSync operation with a local, direct connection, or with infrared communication.

---

The following steps assume that you have already installed Palm Desktop software. See the *Palm™ Tungsten™ C Read This First* installation guide if you have not installed this software.

**To perform a local HotSync operation on a Mac computer:**

1. Place your handheld in the HotSync cradle/cable.

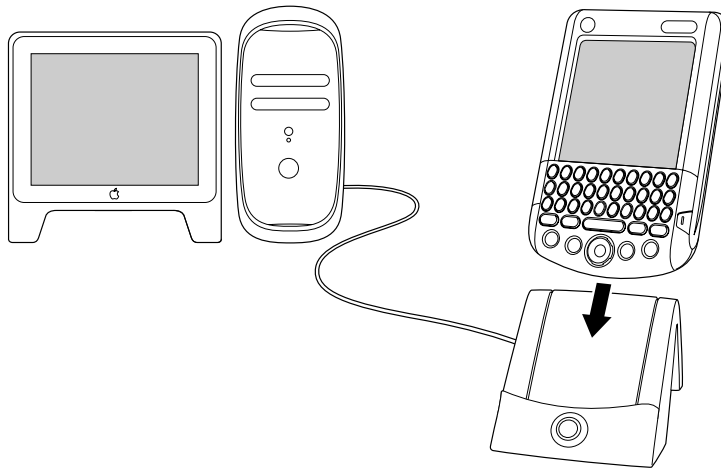

2. Make sure HotSync Manager is enabled: Double-click the HotSync Manager icon  in the Palm folder. Click the HotSync Controls tab and make sure the Enabled option is selected.

3. Press the HotSync button  on the cradle/cable.

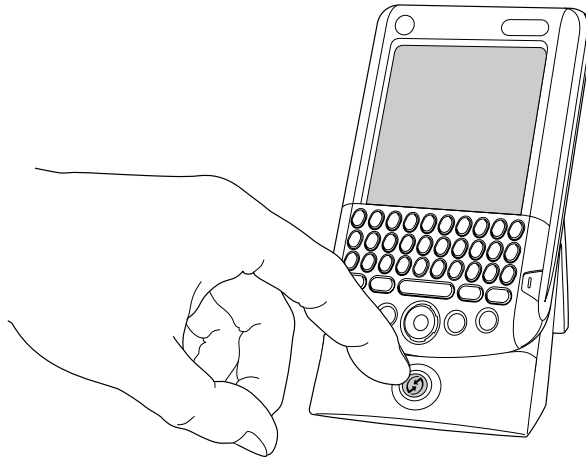

The HotSync Progress dialog box appears, followed by the Select User dialog box.

4. In the Select User dialog box, select the username you entered when you installed the Palm Desktop software, and click OK.

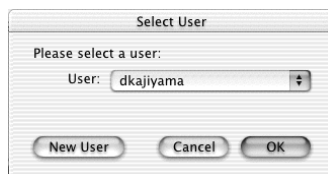

Shown with  
Mac OS X

The HotSync Progress dialog box reappears, and synchronization begins.

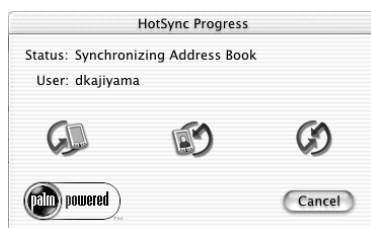

Shown with  
Mac OS X

5. Wait for a message on your handheld indicating that the process is complete.

After the HotSync process is complete, you can remove your handheld from the cradle/cable. Gently tilt your handheld forward in the cradle, and then lift it up to remove it.



## Conducting IR HotSync operations

You can use the infrared (IR) port on your handheld to perform HotSync operations. When you perform an IR HotSync operation, you don't need your cradle/cable. However, you must have a computer that's equipped with an IR port and that supports the IrCOMM implementation of the Infrared Data Association (IrDA) standards. This is especially useful if you travel with an infrared-enabled laptop. You simply enable infrared communication on your laptop and handheld and follow the steps in ["Performing an IR HotSync operation"](#) later in this section.

### Preparing your computer for infrared communication

Before you can perform a HotSync operation using the IR port, the computer with which you want to synchronize must fulfill these requirements:

- Your computer must support the IrCOMM implementation of the IrDA standards.
- Your computer must have an enabled infrared port that's built into the computer, or an enabled infrared device attached to the computer.
- Some desktop computers may require an infrared device attached to a physical COM port. Laptops are likely to have a built-in IR port, so no external device is necessary.
- Your computer must have an installed infrared driver.
- If you have an external infrared device attached to your computer, a driver is probably included with the device. Consult the documentation included with the device for information on installing the required driver.

Check your computer's documentation to learn if the computer supports infrared communication.

#### To configure HotSync Manager for infrared communication on a Windows computer:

- Click the HotSync Manager icon  in the Windows system tray, and make sure that Infrared is checked.
  - If you have an Infrared option on the HotSync Manager menu, and that option is selected, skip to ["Performing an IR HotSync operation."](#)
  - If you do not have an Infrared option on the HotSync Manager menu, complete the following steps:
    - a. Make sure that Local Serial is selected on the menu.
    - b. From the HotSync Manager menu, select Setup.

- c. Click the Local tab.
- d. In the Serial Port drop-down box, select the simulated port that your computer uses for infrared communication.

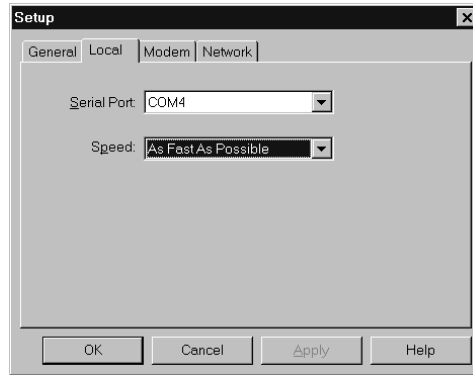

See the documentation for your operating system for instructions on finding the simulated port. This information is usually located in the Control Panel.

- Click OK.

**NOTE** If your cradle/cable is connected to a USB port, you can continue using it while HotSync Manager is configured for infrared communication. If your cradle/cable is connected to a serial port, you cannot use your HotSync cradle/cable again until you reconfigure the HotSync Manager to communicate with the port defined for cradle/cable synchronization.

**To configure HotSync Manager for infrared communication on a Mac computer:**

1. Double-click the HotSync Manager icon  in the Palm folder.
2. In the HotSync Controls tab, select Enabled.
3. Click the Connection Settings tab.
4. Select the On check box next to IR Port.

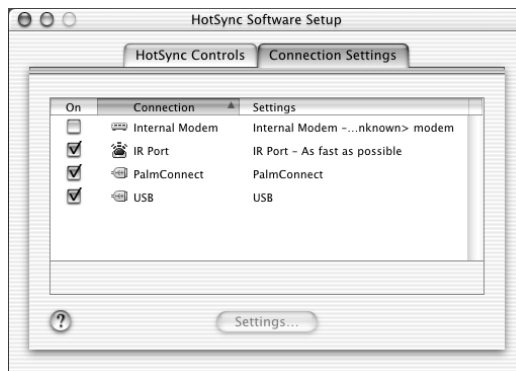



Shown with  
Mac OS X

5. Close the HotSync Software Setup window.

## Performing an IR HotSync operation

After you complete the steps to prepare for performing an IR HotSync operation, it's easy to perform the actual operation.

To perform an IR HotSync operation:

1. Press Home .
2. Tap the HotSync icon .
3. Tap Local.

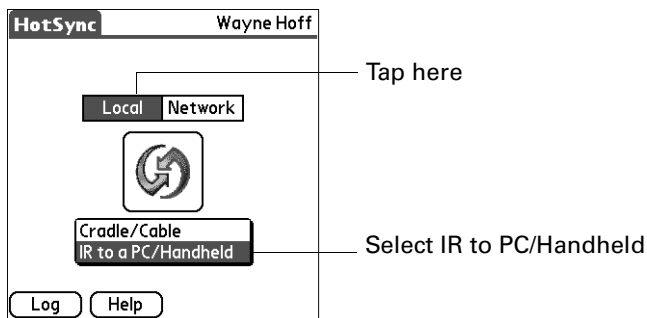

4. Tap the pick list below the HotSync icon and select IR to PC/Handheld.
5. Position the IR port of your handheld within a couple of inches of the infrared port of your computer.
6. Tap the HotSync icon to start the IR HotSync operation.

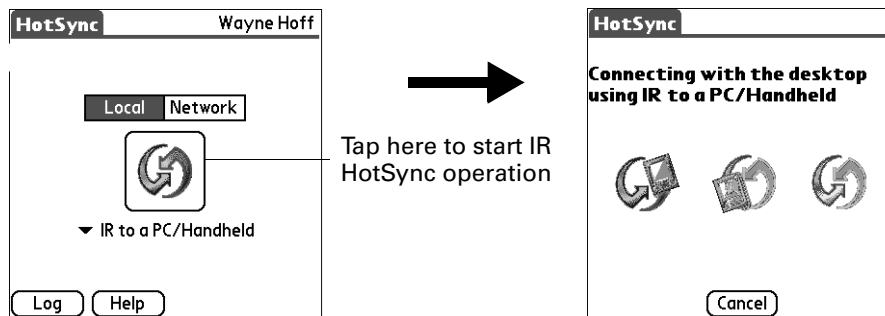

## Returning to cradle/cable HotSync operations

It's easy to return to using the cradle/cable for HotSync operations.

If your cradle/cable is connected to a USB port, you can continue using it while HotSync Manager is configured for infrared communication. Use the following instructions to return to local USB cradle/cable HotSync operations only when necessary, such as when you have disconnected the cradle/cable from the USB port.

**To return to local USB cradle/cable HotSync operations on a Windows computer:**

1. If necessary, connect the cradle/cable to the USB port of the computer you use for HotSync operations.
2. Click the HotSync Manager icon  in the Windows system tray, and select Local USB if it is not already selected.

**To return to local serial cradle/cable HotSync operations on a Windows computer:**

1. If necessary, connect the cradle/cable to the port of the computer you use for HotSync operations.
2. Click the HotSync Manager icon  in the Windows system tray.
3. Choose Setup, and then click Local.
4. Select the COM port where your cradle/cable is connected.
5. Click OK.

**To return to local serial cradle/cable HotSync operations on a Mac computer:**

1. If necessary, connect the cradle/cable to a serial port on your computer.
2. Double-click the HotSync Manager icon  in the Palm folder.
3. In the HotSync Controls tab, select Enabled.
4. Click the Connection Settings tab, and select the correct connection.
5. Close the HotSync Software Setup window.

The next time you want to perform a HotSync operation, just press the HotSync button on the cradle/cable, as you always did before.

## Using File Link

The File Link feature enables you to import Address Book and Memo Pad information onto your handheld from a separate external file such as a company phone list. HotSync Manager stores the data in a separate category on your Palm Desktop software and on your handheld. You can configure the File Link feature to check for changes to the external file when you perform a HotSync operation.

With File Link you can import data stored in any of the following formats:

- Comma-separated (\*.csv)
- Memo Pad archive (\*.mpa)
- Address Book archive (\*.aba)
- Text (\*.txt)

For information on how to set up a file link, see the Palm Desktop online Help.

**NOTE** The File Link feature is not available in Palm Desktop software for Mac.

## Creating a user profile

A user profile enables you to install the same set of data onto multiple Palm OS handhelds before each handheld is individualized with a specific username and data file.

A handheld that is preconfigured with a user profile can be given to anyone because the handheld is not yet identified by a unique username. The handheld acquires a unique username when the new user performs his or her first local HotSync operation.

For example, suppose a sales organization wants to distribute two dozen handhelds that each have a common company phone list, a set of memos, and several key applications. A user profile can be created to install the common data before the handhelds are distributed to the employees who will use them. Then when the employees perform their first HotSync operation, the common data becomes part of their individual data file.

**NOTE** The handhelds that are synchronized with a user profile must be either new ones that have never been synchronized or handhelds that have had their usernames and data removed by a hard reset.

**To create a user profile on a Windows computer:**

1. Open Palm Desktop software.
2. From the Tools menu, select Users.
3. Click Profiles.
4. Click New.

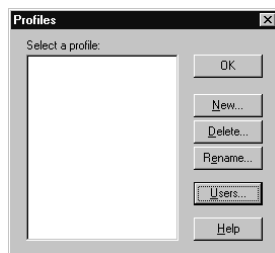

5. Enter a unique name for the profile and click OK.



6. Repeat steps 3 through 5 for each profile that you want to create, and then click OK to return to Palm Desktop software.

7. Select the profile from the User list, and create the data for the profile (for example, a company phone list).

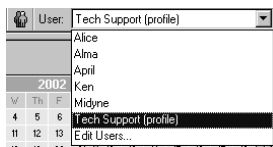

**To create a user profile on a Mac computer:**

1. Open Palm Desktop software.
2. From the User pop-up menu, select Edit Users.
3. Click New Profile.

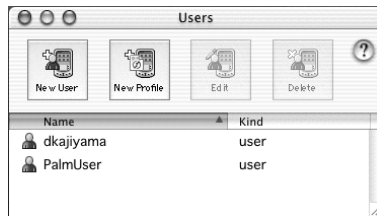

Shown with  
Mac OS X

4. Enter a unique name for the profile and click OK.



Shown with  
Mac OS X

5. Close the Users window.
6. From the User pop-up menu, select the new profile.
7. Create the data for the profile (such as a company phone list).
8. From the HotSync menu, select Conduit Settings.
9. Select the conduit settings for the profile. See [“Customizing HotSync application settings”](#) earlier in this chapter for details.

## Performing the first HotSync operation with a user profile

After you create a user profile, you are ready to transfer the information to the new handheld during the first HotSync operation.

**To use a profile for the first-time HotSync operation on a Windows computer:**

1. Place the new handheld in the cradle/cable.
2. Press the HotSync button  on the cradle/cable.
3. Click Profiles.

4. Select the profile you want to load on the handheld, and click OK.



5. Click Yes to transfer all the profile data to the handheld.

The next time you perform a HotSync operation, Palm Desktop software prompts you to assign a username to the handheld.

**To use a profile for the first-time HotSync operation on a Mac computer:**

1. Connect the new handheld to the HotSync cradle/cable.
2. Press the HotSync button  on the cradle/cable.
3. Select the profile you want to load on the handheld, and click OK to transfer all the profile data to the handheld.

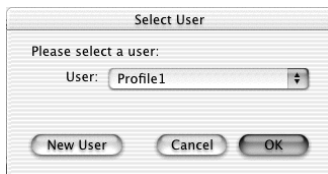

Shown with  
Mac OS X

The next time you perform a HotSync operation, Palm Desktop software prompts you to assign a username to the handheld.





# Setting Preferences for Your Handheld

Preferences enable you to customize the configuration options on your handheld. The options are grouped into three categories: General, Communication, and Personal. Each category provides access to a list of relevant Preferences screens. Use Preferences to do the following:

- Access the General Preferences screens to customize any of the following settings:

<b>Date &amp; Time</b>	Set the location, date, and time.
<b>Digitizer</b>	Calibrate the screen on your handheld.
<b>Formats</b>	Set the country default and the formats for times, dates, calendar, and numbers.
<b>Graffiti 2</b>	Select alternate strokes for selected Graffiti® 2 characters.
<b>Keyboard</b>	Customize the keyboard by remapping the character or function of the key, and setting how each key responds when pressed or held.
<b>Power</b>	Set these features: auto-shutoff interval, Stay on in cradle, and Beam receive.
<b>Sounds and Alerts</b>	Set the alarm options and sounds for your handheld.
<b>Writing Area</b>	Enable and disable Writing Area Preferences and show or hide penstrokes while writing Graffiti 2 characters.

- Access the Communication Preferences screens to customize any of the following settings:

<b>Network</b>	<i>For advanced users:</i> Configure your handheld for use with TCP/IP services or with an ISP.
<b>Connection</b>	Configure cradle, modem, and infrared communication settings.
<b>VPN</b>	Configure your VPN accounts on your handheld.

**Wi-Fi** Turn on the 802.11b radio and set up your Wi-Fi network.

- Access the Personal Preferences screens to customize any of the following settings:

**Buttons** Reassign different applications to the buttons on the front panel of your handheld, and to the HotSync® button on the cradle.

**Color Theme** Select a color theme to change the appearance of your handheld screen.

**Owner** Enter your name, phone number, and other owner information to your handheld.



**Security** Set the security features for your handheld, such as password, private records, and encryption.

**ShortCuts** Define a list of Graffiti 2 abbreviations.

## Setting General Preferences

The General Preferences category enables you to access screens where you can modify Date & Time, Digitizer, Formats, Graffiti 2, Keyboard, Power, Sounds & Alerts, and Writing Area settings. This section provides details about each of these screens.

To open the General Preferences screens:

1. Press Home .
2. Tap the Prefs icon .
3. From the General Preferences list, select the name of the Preferences screen you want to view.

**TIP** You can also press Left, Right, Up, and Down on the navigator to highlight a Preferences screen name and then press Select on the navigator to open that Preferences screen.

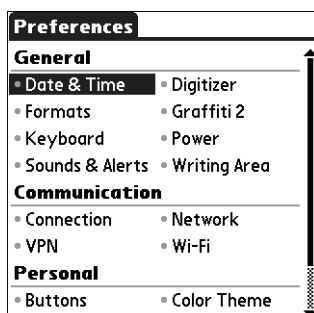

## Date and Time preferences

The Date and Time Preferences screen enables you to set the date, time, time zone. When you select a time zone that supports daylight savings, your handheld automatically makes the time change on the appropriate date.

To set the time zone:

1. Tap the Location pick list.

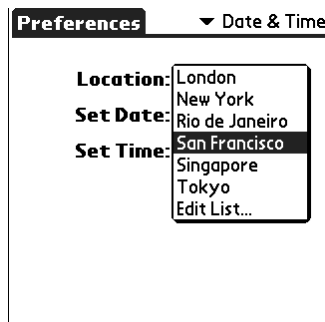

2. Select a time zone.

When you travel, changing the time zone setting to a new time zone automatically resets the date and time on your handheld, but it does not change the time of appointments set in Date Book.

To set the date:

1. Tap the Set Date box.
2. Tap the arrows to select the current year.

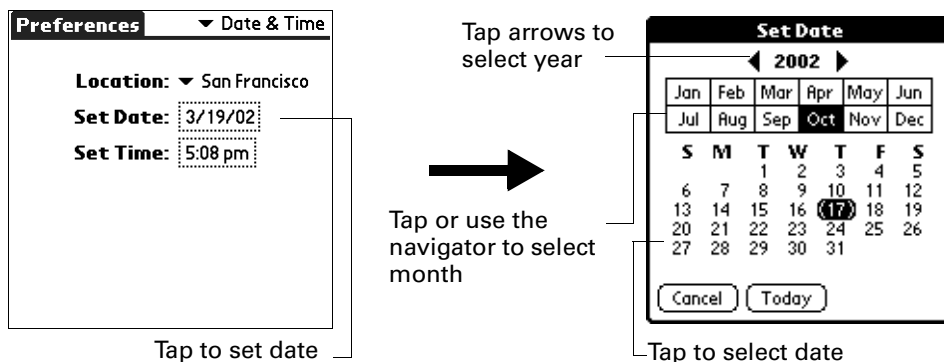



3. Select a month.
4. Tap the current date.

To set the time:

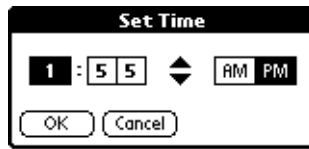
1. Tap the Set Time box.



2. Tap the up or down arrows to change the hour.
3. Tap each number of the minute, and then tap the arrows to change the numbers.
4. Press Function  + Enter , or tap OK.

## Digitizer preferences

The Digitizer Preferences screen opens the digitizer calibration screen. This is the same screen that appears when you start your handheld for the first time.



You can recalibrate your screen after a hard reset, or if your digitizer drifts.

## Formats preferences

Use the Formats Preferences screen to set the country default and the display format of the dates, times, and numbers on your handheld.

### Country default

The country default sets date, time, week start day, and number conventions based on geographic regions where you might use your handheld. For example, in the United Kingdom, time often is expressed using a 24-hour clock. In the United States, on the other hand, time is expressed using a 12-hour clock with an AM or PM suffix.

All your handheld applications use the Country default settings. You can, however, customize your own preferences as described in [“Time, date, week start, and numbers formats”](#) later in this chapter.

**To set the country default:**

- Tap the Preset to pick list and select a country.

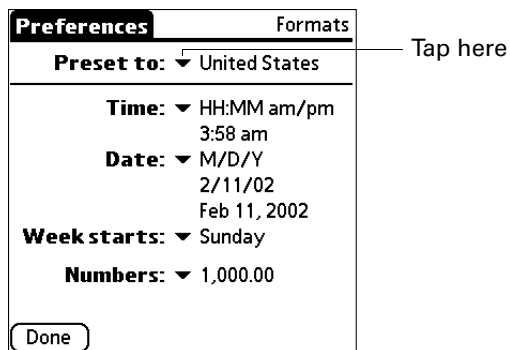
**Time, date, week start, and numbers formats**

The Time setting defines the format for the time of day. The time format that you select appears in all applications on your handheld.

**To select the time, date, week start, and numbers format:**

1. Tap the Time pick list and select a format.
2. Tap the Date pick list and select a format.
3. Tap the Week starts pick list, and select whether you want the first day of the week to be Sunday or Monday.

This setting controls the Day, Week, and Month views in Date Book and all other aspects of your handheld that display a calendar.

4. Tap the Numbers pick list, and select formats for the decimal point and thousands separator.

## Graffiti 2 Preferences

The Graffiti 2 Preferences screen enables you select an alternate stroke shape for specific characters.

**To select alternate strokes:**

1. From the General Preferences list, select Graffiti 2.
2. Tap the letter you want to change.

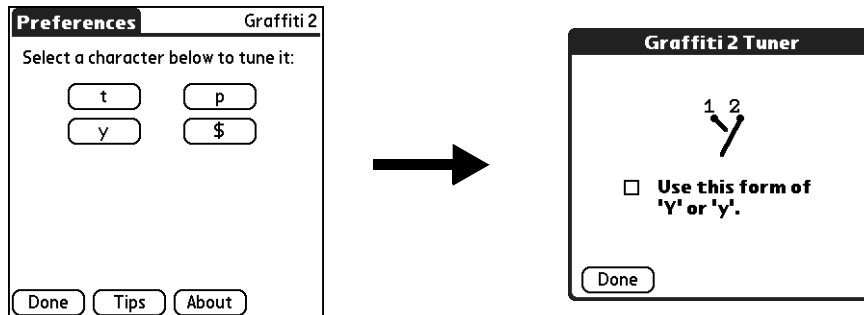

3. Tap the check box to activate the alternate stroke.
4. Tap Done.
5. Repeat steps 2 through 4 for other letters.
6. Tap Done.

## Keyboard preferences

The Keyboard Preferences screen enables you to customize the keyboard. You can set how each key responds when pressed or held. You can also remap the character or function of the key.

Any changes you make in the Keyboard Preferences screen become effective immediately; you do not have to change to a different screen or application.

**To set the key repeat rate:**

- Move the slider or tap the adjustment bar.

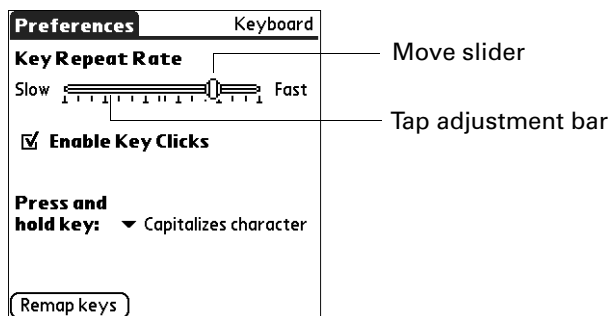

**To set key clicking:**

- Tap check box to enable or disable key clicking.

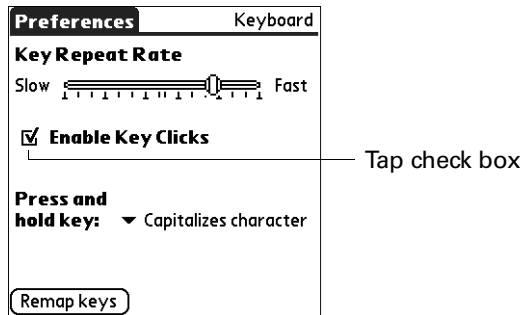
**To set key press-and-hold functionality:**

- Tap the Press and hold key pick list, and select the function.

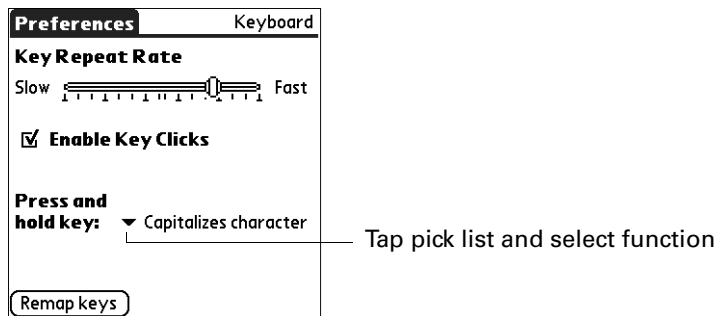
**Remapping keys**

Keys can be remapped from their default function to any of the keys or buttons available on the handheld, including the Function keys.

**To remap a key:**

1. Tap Remap keys.
2. Tap a key.

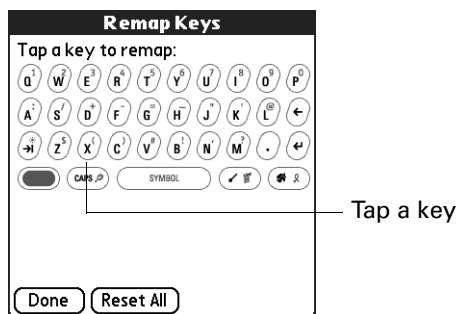

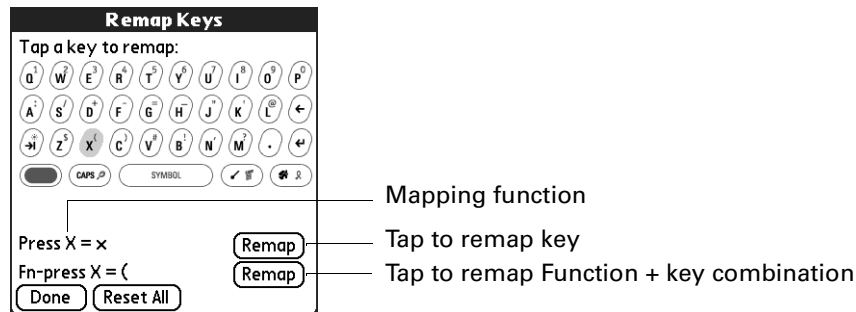

3. Tap Remap.

You can choose to remap the key and the Function + key combination.

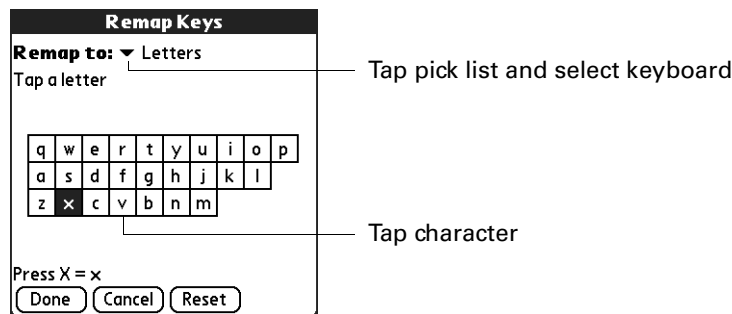

4. Tap Save.



5. Press Function  + Enter , or tap Done.

## Power preferences

The Power preferences screen enables you to set the automatic shutoff interval, and the Beam Receive feature.

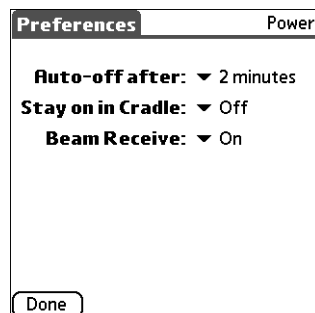

### Auto-off delay

Your handheld has an automatic shutoff feature that activates after a period of inactivity. This feature turns off the power but leaves the radio on. This feature helps conserve battery power in case you forget to turn off your handheld.



If you find that your handheld shuts itself off before you finish reviewing the information on the screen, you should increase the time setting of the automatic shutoff feature.

---

**IMPORTANT** VPN only supports an Auto-off delay of 30 seconds.

---

To set the Auto-off delay:

1. Tap the Auto-off After pick list.

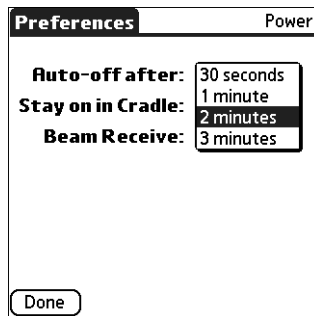

2. Select the setting you want to use for the automatic shutoff feature: 30 seconds, 1 minute, 2 minutes, or 3 minutes.

If you are using VPN, select 30 seconds. You can also choose to manually power off the handheld.

### Cradle settings

You can choose to leave your handheld on when it is in the cradle during a HotSync operation, or when you are recharging the battery, so you can continue to view your data.

To change the cradle setting:

- Tap the Stay on in Cradle check box to leave your handheld on when it is in the cradle.

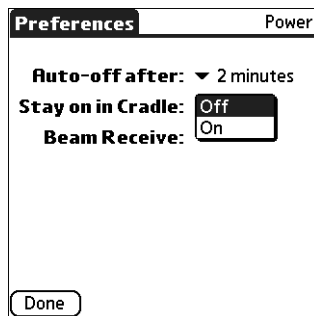

## Beam Receive

You can choose to turn off the Beam Receive feature. This prohibits anyone from beaming information to your handheld. It also results in a slight saving of battery power.

To change the Beam Receive setting:

- Tap the Beam Receive pick list and select On or Off.

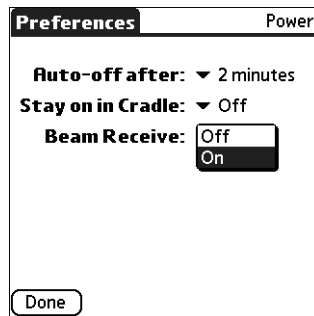

## Sounds and Alerts preferences

The Sounds and Alerts Preferences screen enables you to set the alarm options and sounds for your handheld.

### System, alarm, and game sounds

Your handheld uses a variety of sounds. The System, Alarm, and Game Sound settings enable you to turn the sounds on or off, and to adjust the volume level.

To set the system and alarm sounds:

1. Tap Custom.

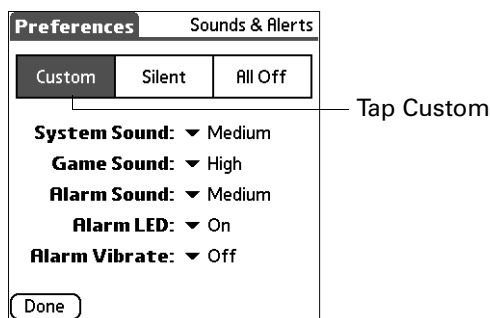

2. Tap the System Sound pick list and select the sound level.

---

**IMPORTANT** When you turn off the System Sounds, you also turn off the “chime” tones associated with the HotSync operation.

---

3. Tap the Game Sound pick list and select the sound level.
4. Tap the Alarm Sound pick list and select the sound level.

The Game Sound setting works only with games that are programmed to respond to this setting. Older games typically do not respond to this setting.

### Alarm Vibrate and indicator light settings

You can set alarms in Date Book, Note Pad and World Clock to remind you of important meetings or notes. When you enable the Alarm Vibrate and indicator light settings, your handheld vibrates and the indicator light blinks to notify you of alarms. This is useful whenever you want to turn the Alarm Sound off but still be notified of alarms.

**To set the Alarm Vibrate and indicator light settings with sound:**

1. Tap Custom.
2. Tap the Alarm Vibrate pick list and select On or Off.
3. Tap the Alarm LED pick list and select On or Off.

**To set the Alarm Vibrate and indicator light settings with no sound:**

- Tap Silent.

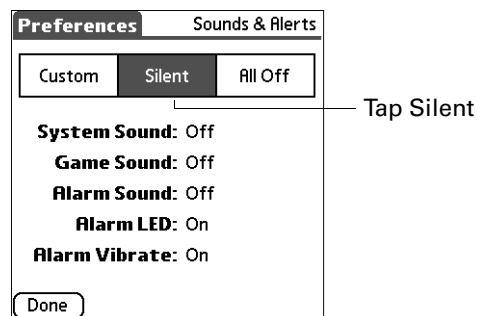

## Writing Area preferences

Writing Area Preferences offer you the option of using the full screen to enter Graffiti 2 characters. When Writing Area Preferences are turned on and active, you can write letters anywhere on the left side of the screen, write numbers anywhere on the right side of the screen, and write capital letters across the imaginary division line in the middle of the screen. You access buttons and other controls that appear on the screen by tapping and holding the control until it activates.

To turn Writing Area Preferences on and off:

1. From the General Preferences list, select Writing Area.

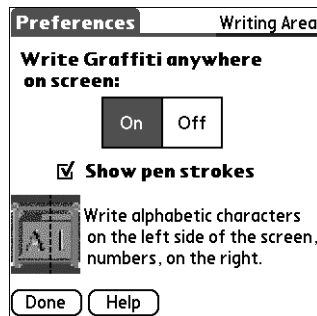



2. Tap On or Off.
3. If you selected On in the previous step, select the Show penstrokes check box to display penstrokes while writing, or deselect this check box to hide penstrokes.
4. Tap Done.

See [“Using Graffiti 2 writing to enter data”](#) in [Chapter 3](#) for details on using full-screen writing to enter data.

## Setting Communication Preferences

The Communication Preferences category enables you to access screens where you can modify Connection, Network, VPN, and Wi-Fi settings. This section provides details about each of these screens.

To open the Communication Preferences screens:

1. Press Home .
2. Tap the Prefs icon .

- From the Communication Preferences list, select the name of the Preferences screen you want to view.

**TIP** You can also press Left, Right, Up, and Down on the navigator to highlight a Preferences screen name and then press Select on the navigator to open that Preferences screen.

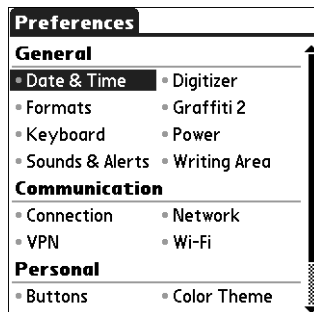

## Connection preferences

The Connection Preferences screen enables you to define the settings used to connect your handheld to other devices. The screen displays a list of available configurations that are ready to be further defined; the list varies depending on the kind of software you've added to your handheld.

You can also create custom configurations, which include the following:

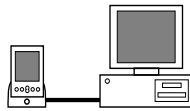

**PC via Cradle/Cable:** A local HotSync connection; the direct connection between your handheld and your desktop computer. Your handheld is connected by its universal connector to the cradle, and the cradle is attached by its cable to a USB port of your desktop computer. (If you are using the optional serial cradle, the cradle attaches by its cable to a serial [COM] port of your computer.)

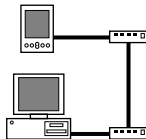

**Modem via Universal Connector:** A cable connection between your handheld's universal connector and a modem for dialing in to a modem that is part of your computer or laptop.

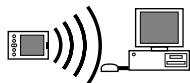

**PC via Infrared:** A connection between the IR port of your handheld and the infrared device of your computer or laptop.



**Modem via Infrared:** A connection between the IR port of your handheld and a modem. The modem can be attached to or within a mobile phone or some other device containing an IR port. (Some IR phones contain modems.)

### IR to PC connection

The following example shows you how to edit the IR to PC/Handheld connection to adjust the communication speed; you can similarly edit other connections or settings or create a custom connection. You can use the IR to PC/Handheld connection to perform a remote IR HotSync operation. To accomplish the HotSync operation, your handheld sends data through its IR port to an IR port in your desktop computer, to synchronize with your desktop application.

To edit the IR to PC/Handheld connection:

1. Tap the IR to PC/Handheld connection and tap Edit.

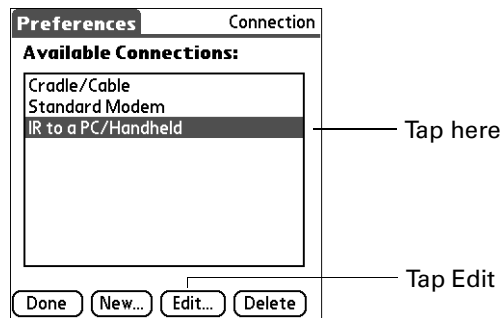



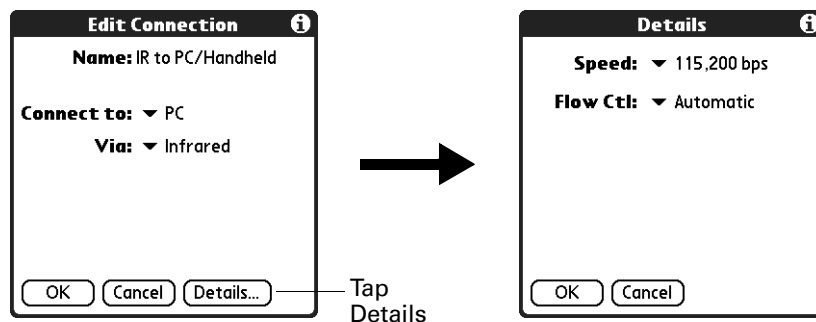

2. Tap Details.

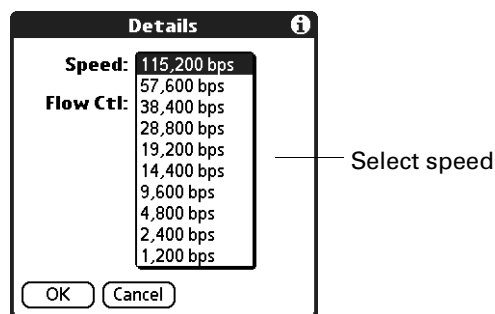

3. Tap the Speed pick list and select the appropriate speed.



4. Press Function  + Enter , or tap OK.
5. Press Function  + Enter , or tap OK again to save the configuration.

After you create the configuration, you need to set up the HotSync Manager of your Desktop application and the HotSync application of your handheld to perform a modem HotSync operation.

## Network preferences

**CAUTION** Network preferences settings are for advanced users only. Changing your Network preferences settings affects your handheld's ability to operate in a wireless environment. Use the Wi-Fi preferences settings to change your network settings. See "[Wi-Fi preferences](#)" later in this chapter.

Your handheld supports 802.11b data connections and acts as a fully functional data modem for circuit-switched connections over GSM.

### Modem Accessory and TCP/IP software

Although your handheld is wirelessly enabled, you can also use TCP/IP software that is included in the handheld operating system to connect with Internet service providers (ISPs) or dial-in (remote-access) servers.

To use TCP/IP, you must create a configuration in the Connection Preferences screen and then create Network Preferences settings.

The Connection Preferences screen enables you to define several ways that your handheld can use a modem to communicate with remote devices. For example, you can communicate with the service provider server, or with your computer if you are traveling. See "[Connection preferences](#)" later in this chapter for a complete explanation of how to create modem configurations.

After you configure both the Connection and Network preferences, you can establish a PPP (Point-to-Point Protocol) connection with your service provider or dial-in server. You can do this either by using menu commands from the Network Preferences screen or by using a third-party application.

**NOTE** TCP/IP enables you to connect to your service provider or dial-in server with applications that allow you to view the transmitted data. Visit the web site [www.palm.com/support/globalsupport](http://www.palm.com/support/globalsupport) for information on third-party applications that take advantage of TCP/IP.

### Selecting a service

Use the Service setting to select the service template for your service provider or for a dial-in server. Service templates are a set of service provider and dial-in server configuration settings that you can create, save, and reuse. Also, you can create new service templates. See "[Creating additional service templates](#)" later in this chapter.

**To select a service:**

1. Tap the Service pick list.

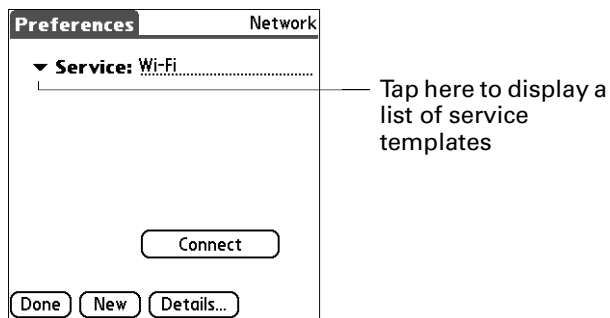

2. Select the predefined service template you want to use.

**Entering a username**

The User Name setting identifies the name you use when you log in to your service provider or your dial-in server. Although this field can contain multiple lines of text, only two lines appear onscreen.

**To enter a username:**

1. Tap the User Name field.
2. Enter your username.

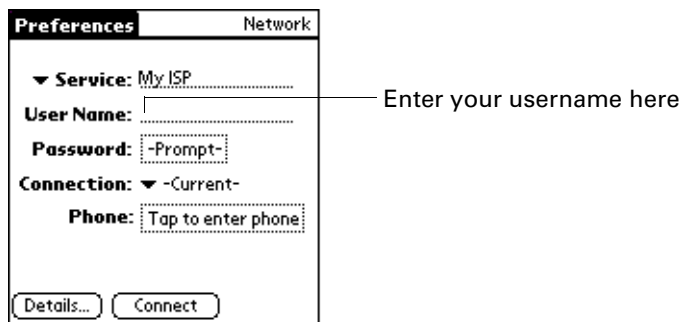

**NOTE** Most dial-in servers do not accept spaces in the username.

**Entering a password**

The Password box identifies the password you use to log in to your server or service provider. Your entry in this field determines whether your handheld prompts you to enter a password each time you log in to your network:

- If you do not enter a password, your handheld displays the word “Prompt” in this field and asks you to enter a password during the login procedure.
- If you enter a password, your handheld displays the word “Assigned” in this field and does not prompt you to enter a password during the login procedure.





If you are concerned about security, select the Prompt option and do not enter a password.

To enter a password:

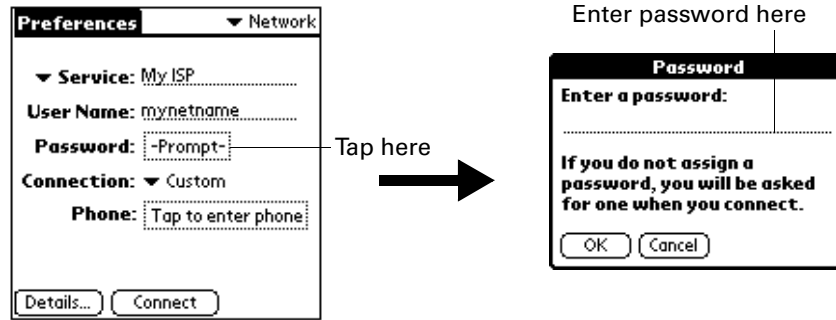
1. Tap the Password box.
2. Enter the password you use to log in to your server.



3. Press Function  + Enter , or tap OK.

The Password field is updated to display the word "Assigned."

### Selecting a connection

Use the Connection setting to select the method you want to use to connect to your service provider or to a dial-in server. See "[Connection preferences](#)" later in this chapter for information about creating and configuring connection settings.

To select a connection:

1. Tap the Connection pick list.

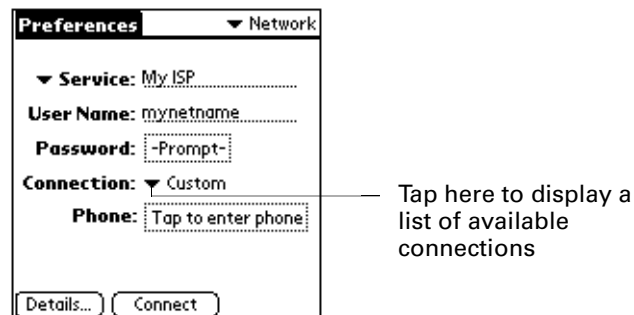

2. Select the connection you want to use.

### Adding telephone settings

Some services require a telephone number. When you select the Phone field, a dialog box opens in which you define the telephone number you use to connect with your service provider or dial-in server. In addition, you can define a prefix, disable call waiting, and give special instructions for using a calling card.

To enter your server phone number:

1. Tap the Phone field.
2. Enter the phone number for your service provider or dial-in server.

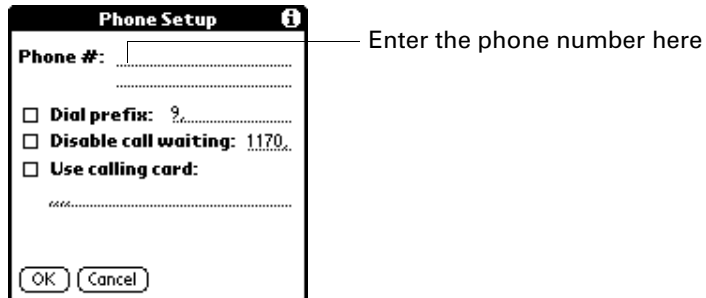

3. If you need to enter a prefix or disable call waiting, skip to those procedures. Otherwise, press Function  + Enter , or tap OK.



### Entering a prefix

A prefix is a number that you dial before the telephone number to access an outside line. For example, many offices require that you dial “9” before dialing a number outside the building.

To enter a prefix:

1. Tap the Dial prefix check box to select it.



2. Enter the prefix.
3. Press Function  + Enter , or tap OK.

### Disabling call waiting

Call waiting can cause your session to terminate if you receive a call while you are connected. If your telephone has call waiting, you need to disable this feature before logging in to your service provider or dial-in server.

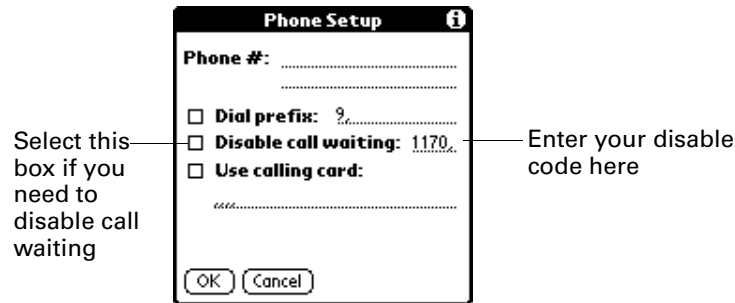

**To disable call waiting:**

1. Tap the Disable call waiting check box to select it.



2. Enter the code to disable call waiting on the Disable call waiting line.

Each telephone company assigns a code to disable call waiting. Contact your local telephone company for the code that is appropriate for you.

3. Press Function  + Enter , or tap OK.

**Using a calling card**

The Use calling card field enables you to use your calling card when dialing your service provider or Internet server. Keep in mind that there is usually a delay before you enter your calling card number. When you define your calling card number, you need to add commas at the beginning to compensate for this delay. Each comma delays transmission of your calling card number for two seconds.

**To use a calling card:**



1. Tap the Use calling card check box to select it.



2. Enter your calling card number on the Use calling card line.

**NOTE** The Phone Setup dialog box works correctly for AT&T and Sprint long-distance services. However, because MCI works differently, MCI customers need to put the calling card number in the Phone # field and the phone number in the Use calling card field.

**TIP** It's a good idea to add at least three commas before your calling card number to compensate for the cue delay.

3. Press Function  + Enter , or tap OK.

### Connecting to your service

After you set your Connection and Network preferences, establishing a connection to your service provider or to your company's network (dial-in server) is easy.

#### To establish a connection:

- Tap Connect to dial the current service and display the Service Connection Progress messages.

To see expanded Service Connection Progress messages, press the lower half of the Scroll button.

#### To close a connection:



- Tap Disconnect to terminate the connection between your handheld and your service.

### Creating additional service templates

You can create additional service templates by duplicating existing templates and editing information. After you create a duplicate template, you can add and edit settings.

#### To duplicate an existing service template:

1. Tap the Service pick list.
2. Select the predefined service template you want to duplicate.
3. Press Command Stroke  + L.

Alternately, press Function  + Menu , and then select Duplicate on the Service menu.

A copy of the service template is added to the Service pick list.

### Adding detailed information to a service template

If you are using one of the predefined service templates, you probably need to enter only your username and telephone number. If you are creating a new service template, you may need to provide additional information to your service provider or dial-in server. You use the Details dialog box to add more information to a selected service template.

**To add connection details:**

1. Tap the service field.
2. Tap Details.

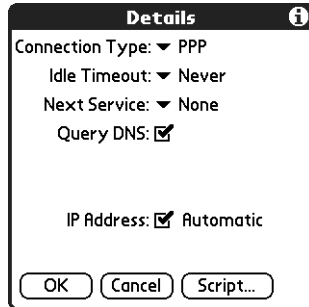
**Idle timeout**



The Idle timeout setting defines how long your handheld waits before dropping the connection with your service provider or dial-in server when you switch out of a TCP/IP application.

**To set the Idle timeout:**

1. Tap the Idle timeout pick list and select one of the following options:

- |                  |   |
|------------------|---|
| <b>1 minute</b>  | Waits one minute for you to open another application before it drops the connection.            |
| <b>2 minutes</b> | Waits two minutes.  |
| <b>3 minutes</b> | Waits three minutes.  |
| <b>Never</b>     | Maintains your PPP or SLIP connection until you turn off your handheld (or until it times out). |

**CAUTION** By enabling this option, you may incur significant charges if the connection to your service provider is left open.

2. Press Function  + Enter , or tap OK.

**Selecting Next Service**

Next Service allows you to automatically try another connection method when the primary method fails. If the current connection fails, then a connection to the selected service is attempted. If you do not want to try another service connection, select None.

**To select the Next Service:**

- Tap the Next Service pick list and select a service.

### Defining primary and secondary DNS

The Domain Naming System (DNS) is a mechanism in the Internet for translating the names of host computers into IP addresses. When you enter a DNS number (or IP address) you are identifying a specific server that handles the translation services.

Each IP address has four sections, separated by periods. In the Details dialog box, you enter each section separately. Each section of an IP address is made up of a number from 0 to 255; numbers are the only allowable characters in this field.

Ask your service provider or system administrator for the correct primary or secondary DNS IP numbers.

Many systems do not require that you enter a DNS number. If you are not sure, leave the DNS field blank.

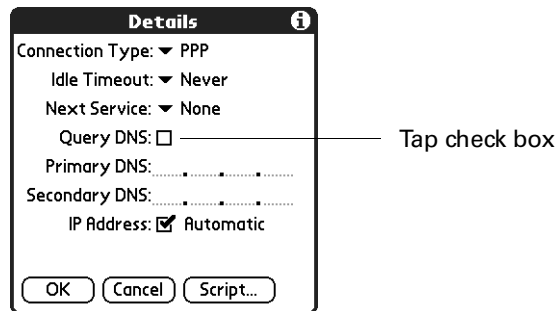

#### To enter a primary and secondary DNS number:

1. Tap the Query DNS check box to deselect it.



2. Tap the space to the left of the first period in the Primary DNS field, and then enter the first section of the IP address.

Each section must be a number from 0 to 255.

3. Repeat step 2 for the second, third, and last sections of the Primary DNS field.
4. Repeat steps 2 and 3 for the secondary DNS number.
5. Press Function  + Enter , or tap OK.

### IP address

Everyone who logs in to the Internet needs to have a unique identifier (an IP address), whether permanent or temporary. Some networks dynamically assign a temporary IP address when clients log in. The IP Address field lets you identify whether your network provides automatic (dynamic) temporary IP addressing.

If your IP address is permanently assigned, you need to get that information from your system administrator. If you are not sure, select Automatic.

**To identify dynamic IP addressing:**

- Tap the IP Address check box to select it.

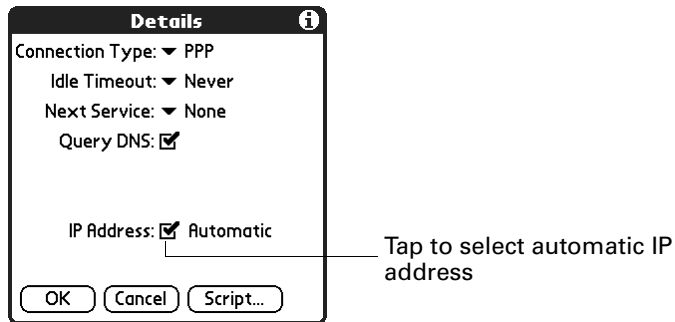

**To enter a permanent IP address:**

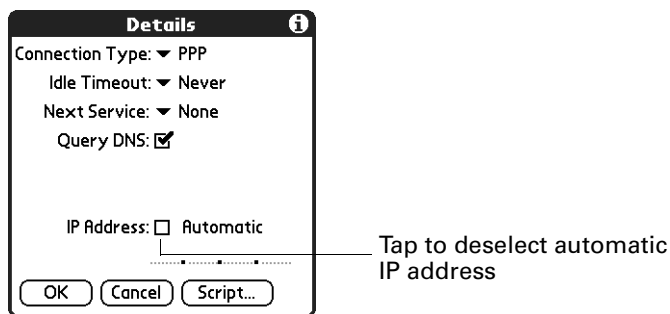
1. Tap the IP Address check box to deselect it and display a permanent IP address field below the check box.



2. Tap the space to the left of the first period, and then enter the first section of the IP address.

Each section must be a number from 0 to 255.

3. Tap and enter the remaining sections of the IP address.
4. Press Function  + Enter , or tap OK.

**Login scripts**

A login script is a series of commands that automates logging in to a network server—for example, your corporate network or your wireless service provider. A login script is associated with a specific service template created in Network Preferences.

A login script is something that you are likely to receive from your system administrator if your company has a system in which you log in to the corporate servers from your handheld using a modem or network connection. The script is generally prepared by the system administrator and distributed to users who need it. It automates the events that must take place in order to establish a connection between your handheld and the corporate servers.

You can create login scripts from the Login Script dialog box on your handheld, accessed from the Details dialog box in Network Preferences.

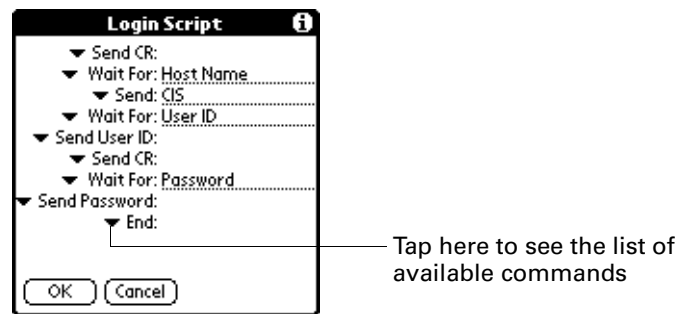

**NOTE** You can also use non-ASCII and literal characters in your login script.

### Creating a login script on your handheld

You can create login scripts by selecting commands from the Command pick list in the Login Script dialog box. Some commands, such as Send, require you to supply additional information. Those commands have a parameter field so that you can add the necessary data.

To create a login script:

1. Tap Script.
2. Tap the End pick list.

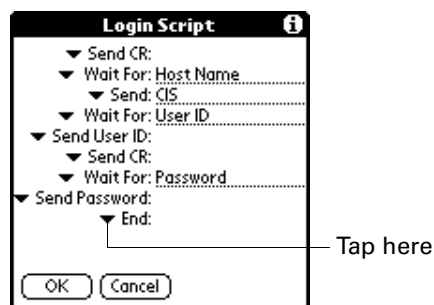



3. Select the command you want from the Command list. If the command requires additional information, a field appears to the right of it for you to enter the information. The following commands are available:

- |                        |   |
|------------------------|---|
| <b>Wait For</b>        | Tells your handheld to wait for specific characters from the TCP/IP server before executing the next command.   |
| <b>Wait For Prompt</b> | Detects a challenge-response prompt coming from the server and then displays the dynamically generated challenge value. You then enter the challenge value into your token card, which in turn generates a response value for you to enter on your handheld. This command takes two arguments, separated by a vertical bar ( ) on the input line. |



<b>Send</b>	Transmits specific characters to the TCP/IP server to which you are connecting.
<b>Send CR</b>	Transmits a carriage return or LF character to the TCP/IP server to which you are connecting.
<b>Send User ID</b>	Transmits the user ID information entered in the User ID field of the Network Preferences screen.
<b>Send Password</b>	Transmits the password entered in the Password field of the Network Preferences screen. If you did not enter a password, this command prompts you to enter one. The Password command is usually followed by a Send CR command.
<b>Delay</b>	Tells your handheld to wait a specific number of seconds before executing the next command in the login script.
<b>Get IP</b>	Reads an IP address and uses it as the IP address for your handheld. This command is used with SLIP connections.
<b>Prompt</b>	Opens a dialog box and prompts you to enter text of some kind (for example, a password or a security code).
<b>End</b>	Identifies the last line in the login script.

- Repeat steps 2 and 3 until the login script is complete.
- Press Function  + Enter , or tap OK.

### Plug-in applications

You can create plug-in applications containing script commands that extend the functionality of the built-in script commands. A plug-in application is a standard PRC application that you install on your handheld just like any other application. After you install the plug-in application, you can use the new script commands in a login script.

Plug-in applications have the following characteristics:

- Written in C language
- Compiled into a device executable
- Called properly from a login script
- Able to return control to a login script after it terminates
- Created using a development environment that supports Palm OS® software, such as Metrowerks CodeWarrior for Palm Platform.

For additional information on creating plug-in applications, send e-mail to Palm Developer Support at [devsupp@palm.com](mailto:devsupp@palm.com).



### Deleting a service template

There is only one way to delete a service template: use the Delete command from the Service menu.

To delete a service template:

1. Tap the Service pick list.
2. Select the service template you want to delete.
3. Press Command Stroke  + D.

Alternately, press Function  + Menu , and then select Delete on the Service Menu.

4. Press Function  + Enter , or tap OK.

### Network preferences menu commands

The Network Preferences screen includes menu commands to make it fast and easy to create and edit service templates. See “Using menus” in Chapter 4 for more information about choosing menu commands.

#### Service menu

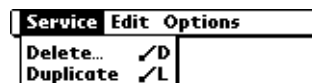

#### Options menu



#### View Log

The Network Log lists all the communication that occurs between your modem and your dial-in server during the login procedure. The information in the Network Log can help your service provider or your system administrator pinpoint where the login procedure communication fails and why.

## VPN preferences

A VPN (Virtual Private Network) client uses popular authentication and encryption technologies along with the Point-to-Point Tunneling Protocol (PPTP) to establish a secure connection to your private network. A VPN allows you to securely access a private network, such as your home or corporate LAN, to perform tasks such as HotSync operations, access intranet mail or corporate servers, and remotely control your PC.

Using this VPN requires access to a VPN server running the PPTP protocol. PPTP server support is available as part of many platforms including many Cisco platforms, several Microsoft operating systems, Linux and other firewall/VPN servers.

---

**IMPORTANT** If your corporate network requires the use of a VPN account, contact your network administrator for setup information.

---

The VPN Preferences allows you to setup and manage your VPN account on your handheld. This section describes how to configure and setup your account so that it is used for all future network connections.

### Configuring your VPN account

You can set up and edit your VPN account.

To set up your VPN account:

1. Tap VPN pick list and select Enable.

By default, VPN is disabled.

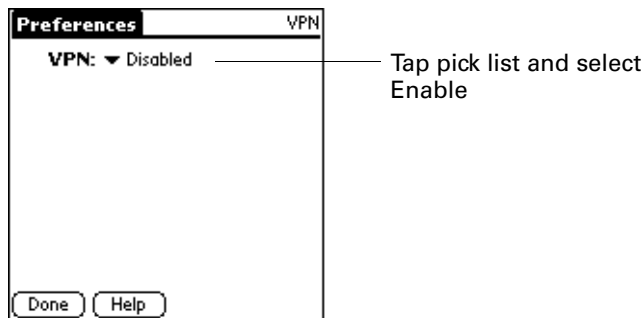

2. Tap the Account field to begin the setup wizard.

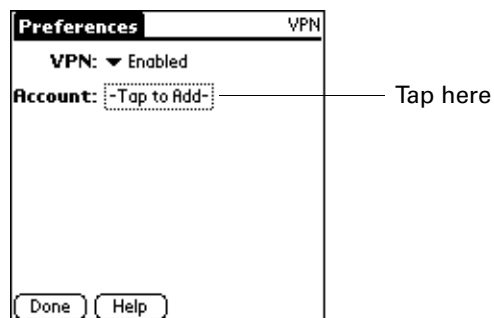

3. Fill out the information required by each screen.

When you are finished, your VPN service is enabled and the account active. When VPN is enabled, the selected account is used for all future connections.

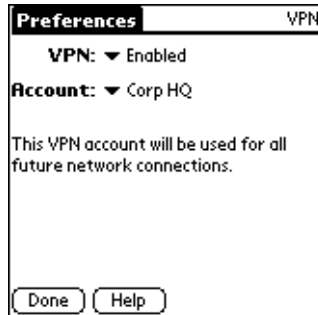

To edit your VPN account or add a new account:

1. Tap VPN pick list and select Enable.

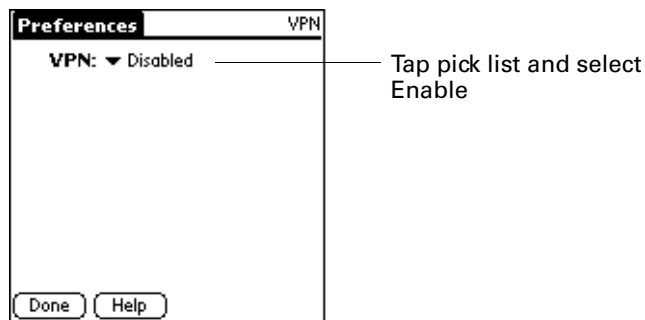

2. Tap the Account button and select Edit Accounts.

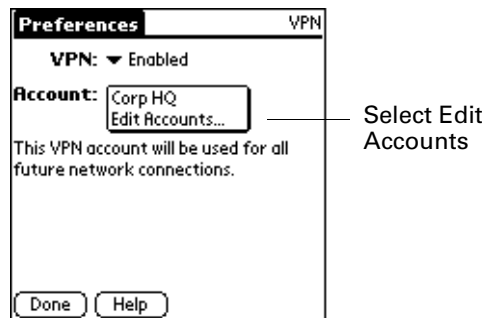

3. Perform one of the following:
  - Select the account and tap Edit to edit the current account.
  - Tap Add to add a new account

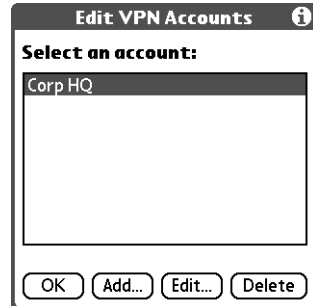

4. Follow the instructions to add a VPN account or edit your current VPN account.
 

When you are finished, your VPN service is enabled and the account is active with the new settings. When VPN is enabled, the selected account is used for all future connections.

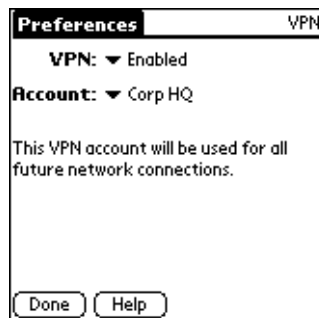

### Connecting to your VPN account

You can connect to your VPN account from the Preferences screen.

To connect to your VPN account:

1. Select an account from the Account pick list.

The account you selected is used for all future connections.

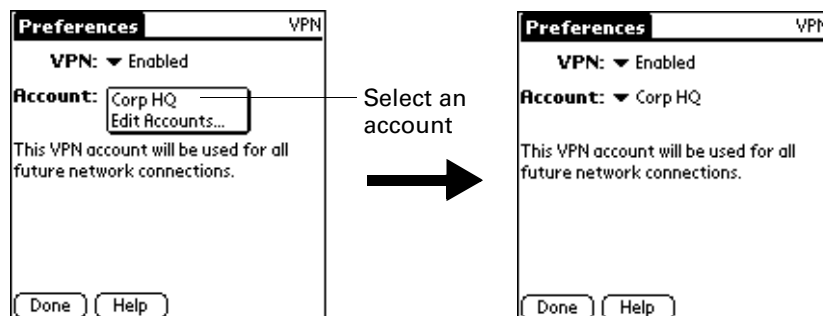

2. Make a Wi-Fi connection using the Wi-Fi preferences screen or an Internet application, such as Palm™ VersaMail™ or PalmSource® Web Browser.

A signing-in screen should appear indicating that you are connecting to your VPN account.



Example of a signing-in screen

3. Check your connection by pressing Command stroke  and verifying that a lock icon appears in the radio signal strength indicator.



Verify lock appears in radio signal strength indicator

4. (Optional) Tap the VPN pick list and select Disable when you have finished accessing the account.

You do not need to disable VPN after each use. You can leave the account enabled so that it is available for the next connection. Check with your IT department for your organization's policy on the use of your VPN account.

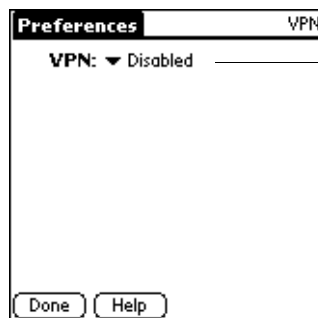

Tap pick list and select Disable

## Wi-Fi preferences

The Wi-Fi Preferences screen allows you to configure your 802.11b network settings and view network status.

---

**IMPORTANT** Your Tungsten C handheld operates in the Industry Scientific and Medical band (ISM). Not all countries support all channels in the ISM band. Because the regulations for wireless communication vary between countries, the Tungsten C handheld is only certified for use in the country where it was originally sold. For more information on which channels your handheld supports, see [Appendix C](#).

---

### Turning the 802.11b radio on and off

The Wi-Fi preferences screen allows you to turn the 802.11b radio on and off. It also indicates what network you are connected to and whether you are out of range.

**NOTE** If the Signal field indicates that there are no networks within range, the 802.11b radio continues to check for a network until you turn the radio off. If you move to an area that is within range and the radio is on, Wi-Fi automatically connects.

To turn the 802.11b radio on or off:

- Tap the Wi-Fi pick list and select On or Off.

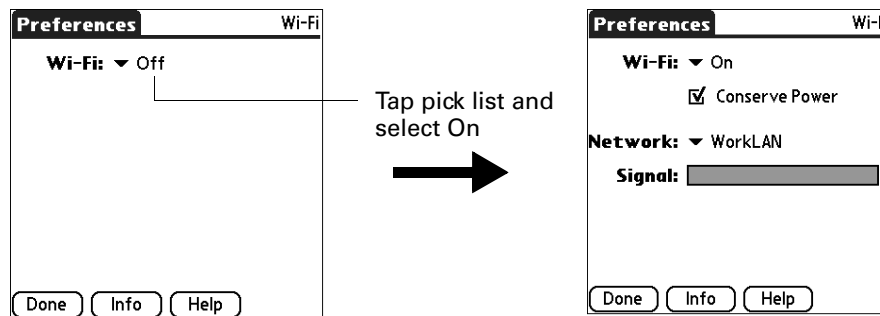

### Finding Wi-Fi connection information

Your IT administrator may need your MAC (Media Access Control) address. The Wi-Fi Info screen shows you the address and other Wi-Fi information.

**To view Wi-Fi information:**

- Tap Info.

When you are disconnected from the network, the Wi-Fi Info screen shows only the MAC address.

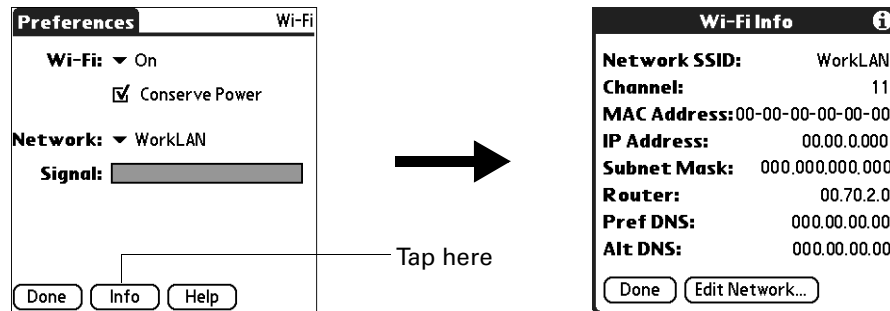
**Conserving battery power**

You can extend your battery power by selecting the Conserve power option. This option dynamically adjusts the coverage area and polling rate to use less power.

**To conserve battery power:**

- Tap Conserve power.

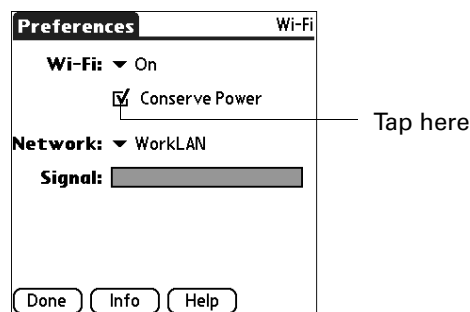
**Adding and editing a Wi-Fi connection**

You can add a new Wi-Fi network connection or edit an existing connection. The connection can be an infrastructure access point type connection, such as network connections found on company sites, or it can be a peer-to-peer or ad-hoc connection, such as a laptop that acts as an access point for your handheld.



To add or edit an infrastructure access point Wi-Fi network:

1. Tap Wi-Fi in the Preferences main screen.
2. Tap the Network pick list and select Edit Networks.

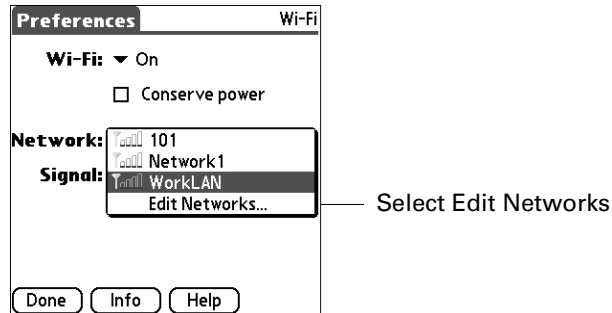

3. Perform one of the following:
  - Select a network and tap Edit.
  - Tap Add.

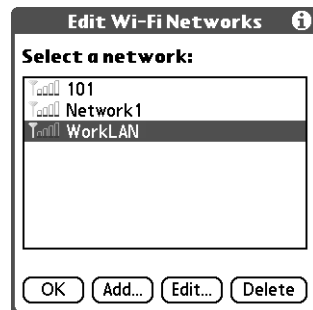

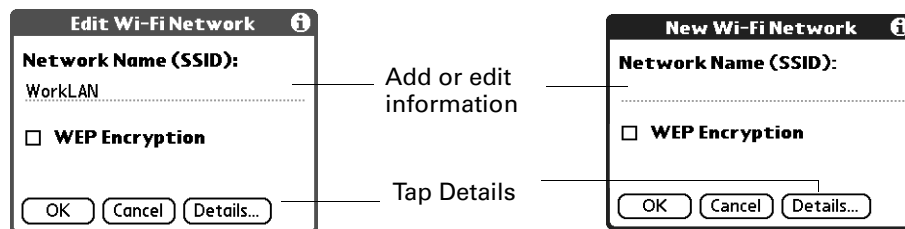

4. Edit or add the information.

If you are adding WEP encryption, see [“WEP Encryption”](#) later in this chapter.



5. Perform one of the following:

- Press Function  + Enter , or tap OK if you want the IP and DNS addresses automatically retrieved or you do not want to change the IP or DNS addresses.
- Tap Details to manually set your IP or DNS addresses.

6. Select Access Point (infrastructure).

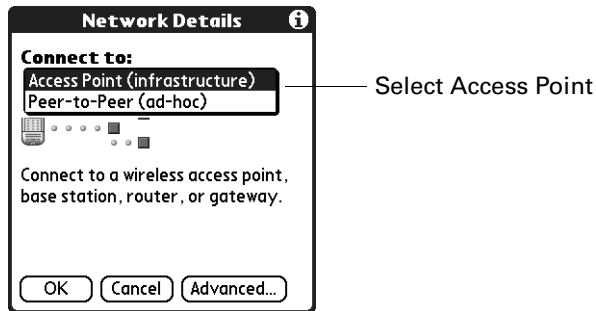

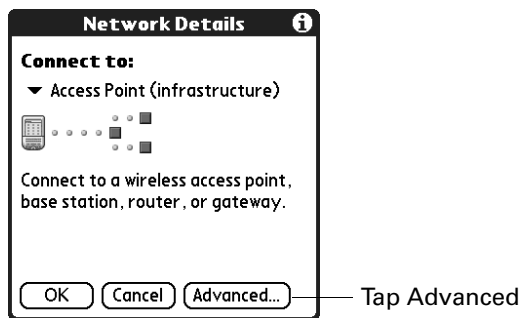

7. Tap Advanced.

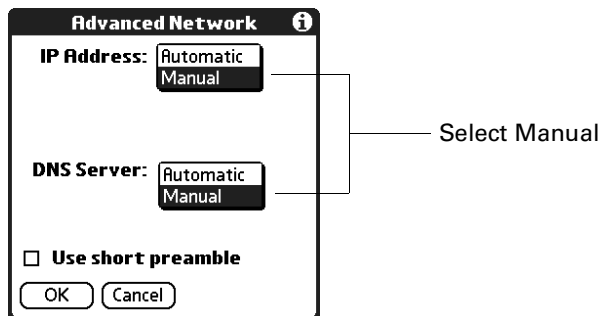

8. Tap the IP Address or DNS Server pick list and select Manual.



9. Add the addresses and press Function  + Enter , or tap OK.

You can also choose to use a short preamble by selecting the Use short preamble check box.

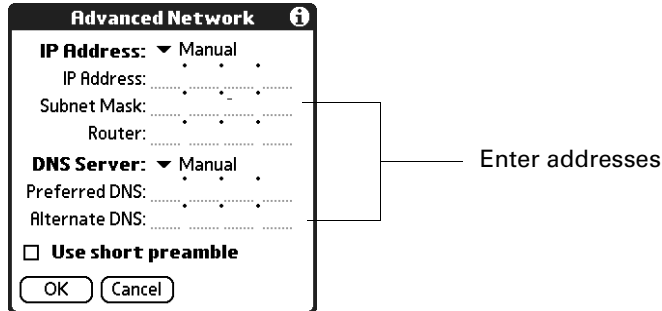

To add or edit a peer-to-peer (ad-hoc) Wi-Fi network:

1. Tap Wi-Fi in the Preferences main screen.
2. Tap the Network pick list and select Edit Networks.

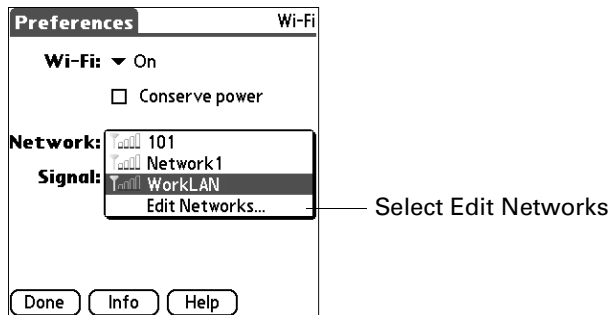

3. Perform one of the following:
  - Select a network and tap Edit.
  - Tap Add

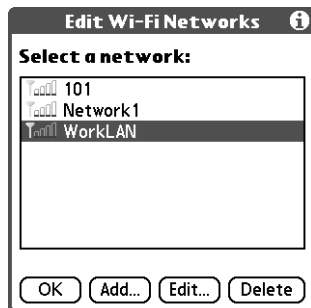

4. Edit or add the information.

If you are adding WEP encryption, see “WEP Encryption” later in this chapter.

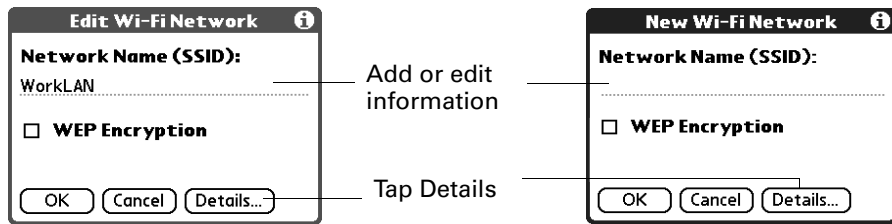

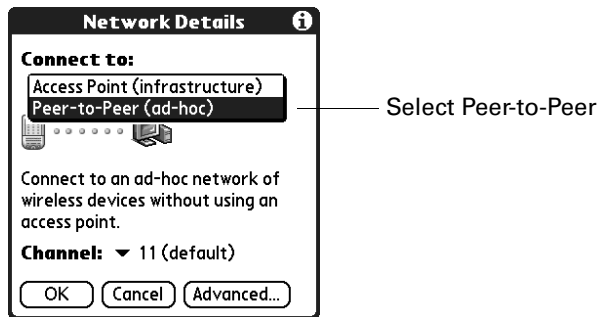

5. Tap Details.
6. Tap the connection type pick list and select Peer-to-peer (ad-hoc).

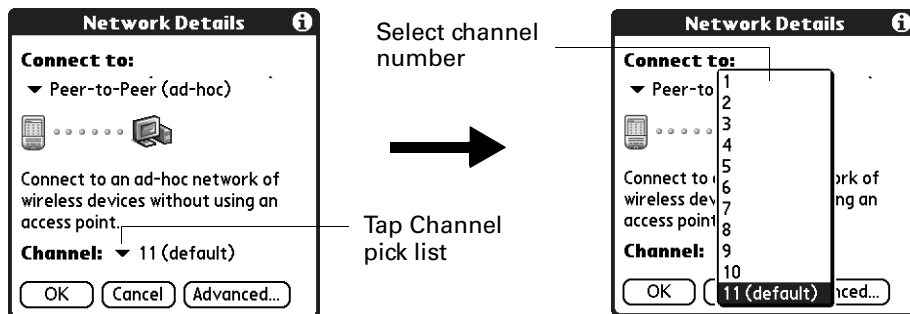

7. Tap the Channel pick list and select the channel number.



8. Perform one of the following:

- Press Function  + Enter , or tap OK if you want the IP and DNS addresses automatically retrieved.
- Tap Advanced to manually set your IP or DNS address.

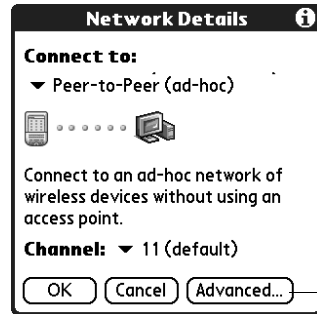

Tap Advanced to manually set IP or DNS addresses

9. Tap IP Address or DNS Server pick list, and select Manual.

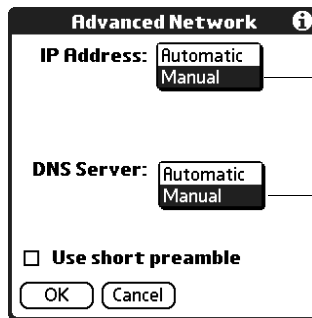

Select Manual

10. Enter the addresses and press Function  + Enter , or tap OK.

You can also choose to use a short preamble by selecting the Use short preamble check box.

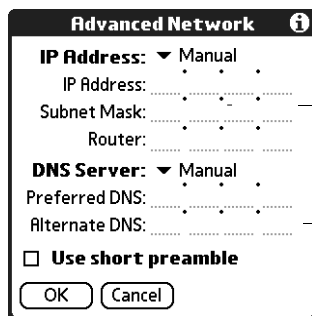

Enter addresses

## WEP Encryption

Wired Equivalent Privacy (WEP) is the standard 802.11b security protocol. Data encryption protects the vulnerable wireless link between clients and access points.

40-bit keys are commonly called 64-bit, and 104-bit keys are commonly called 128-bit because the other 24 bits are automatically assigned. You can use a passphrase to generate the key. If you have problems, ask your IT administrator for the hex equivalent and use that instead of the passphrase. If you use an Airport Base Station, refer to the Airport Admin Utility for the equivalent network password.

To add or edit WEP encryption:

1. Tap Wi-Fi in the Preferences main screen.
2. Tap the Network pick list and select Edit Networks.
3. Select a network and tap Edit.
4. Tap to select the WEP Encryption check box.

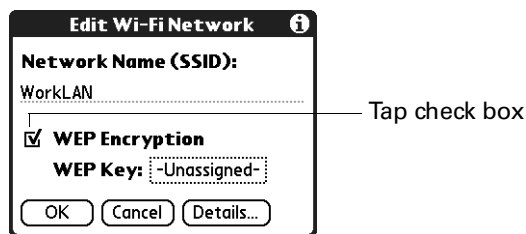

5. Tap WEP Key box.

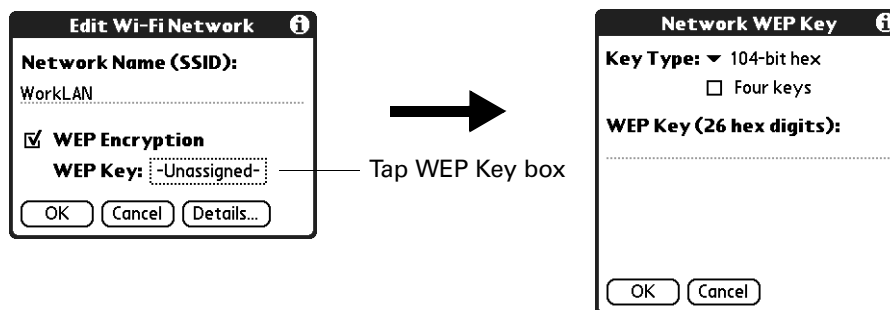

6. Tap Key Type pick list and select a WEP key type.

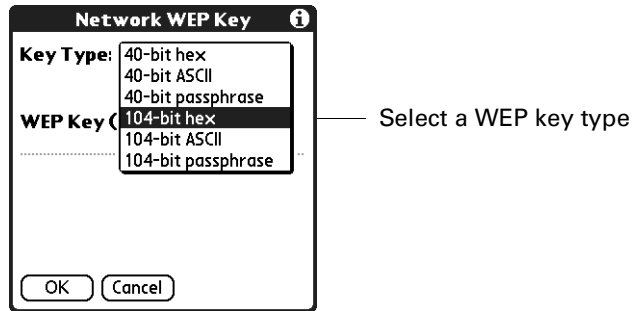

The following WEP key types are available:

- |                           |  |
|---------------------------|--|
| <b>40-bit hex</b>         | Creates a 10-digit hexadecimal number. |
| <b>40-bit ASCII</b>       | Creates a five-character string.       |
| <b>40-bit passphrase</b>  | Creates a variable-length string.      |
| <b>104-bit hex</b>        | Creates a 26-digit hexadecimal number. |
| <b>104-bit ASCII</b>      | Creates a 13-character string.         |
| <b>104-bit passphrase</b> | Creates a variable-length string.      |

7. Select the Four keys check box to enter four keys or generate four keys from a passphrase.

If you don't select the Four keys check box, you only enter one key.

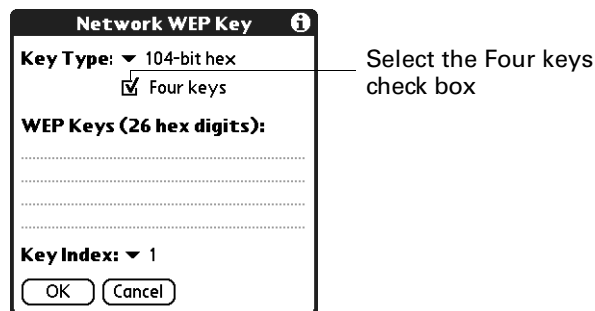

8. Enter the WEP key.

If the Four keys check box is selected, you enter four keys.

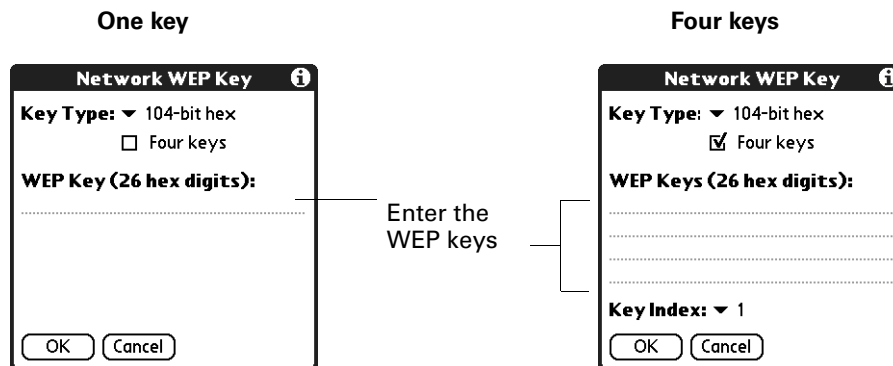

9. Tap the Key Index pick list and select an index number if you selected the Four keys check box.

The index number specifies which of the four keys to use at a given time. Some access points automatically broadcast their key index.

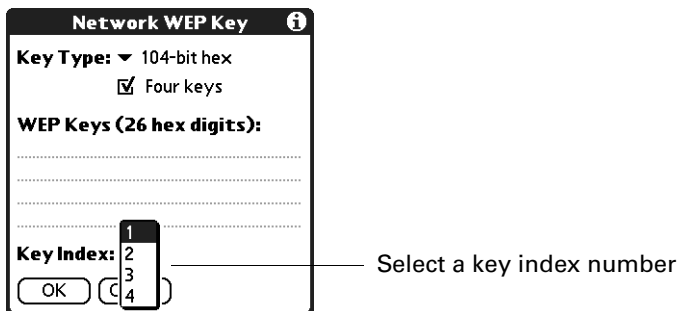

## Setting Personal Preferences

The Personal Preferences category enables you to access screens where you can customize the buttons, colors, owner information, and Graffiti 2 ShortCuts on your handheld. This section provides details about each of these screens.

To open the Personal Preferences screens:

1. Press Home (🏠).
2. Tap the Prefs icon (⚙️).



- From the Personal Preferences list, select the name of the Preferences screen you want to view.

**TIP** You can also press Left, Right, Up, and Down on the navigator to highlight a Preferences screen name and then press Select on the navigator to open that Preferences screen.

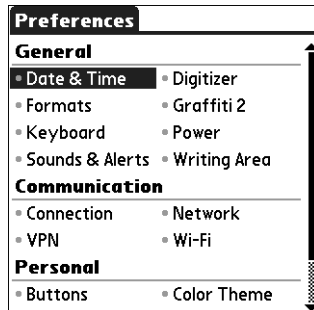

## Buttons preferences

The Buttons Preferences screen enables you to associate different applications with the buttons on the front of the handheld.

Any changes you make in the Buttons Preferences screen become effective immediately; you do not have to change to a different screen or application.

If you assign a different application to a button, you can still access the original application using the Applications Launcher.

**To change the Buttons preferences:**

- Tap the pick list next to the button you want to reassign.

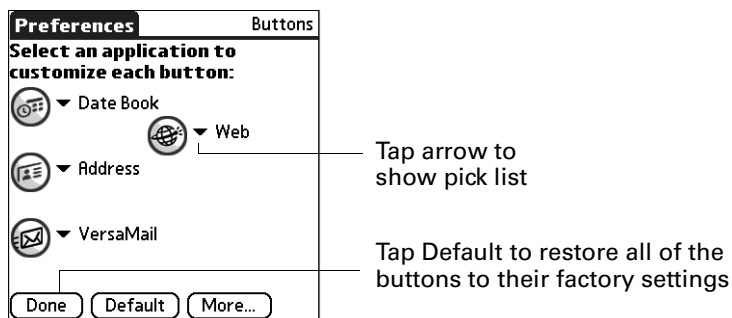

- Select the application that you want to assign to the button.

### HotSync Buttons Preferences

The Buttons Preferences screen also enables you to associate various applications with the HotSync button on the cradle/cable and the HotSync button on an optional modem accessory. Any changes that you make in the HotSync Buttons dialog box become effective immediately; you do not have to change to a different screen or application.

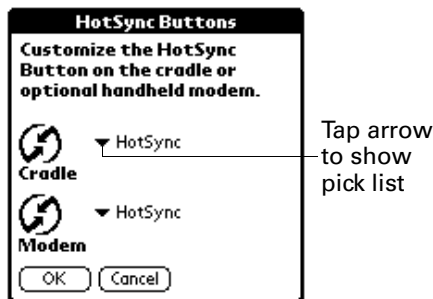

To change the HotSync Buttons Preferences:

1. Tap More.
2. Tap the pick list next to the button you want to assign.



3. Select the application that you want to assign to each button.

The default setting for each button is the HotSync setting, which means that the cradle/cable and optional modem accessories perform their normal HotSync functions.

4. Press Function  + Enter  twice, or tap OK twice to return to the Buttons Preferences screen.
5. Press Function  + Enter , or tap Done.

### Color Theme preferences



The Color Theme Preferences screen enables you to select a different set of pre-defined colors for your handheld screen.

**To select a color theme:**

1. Select a theme.

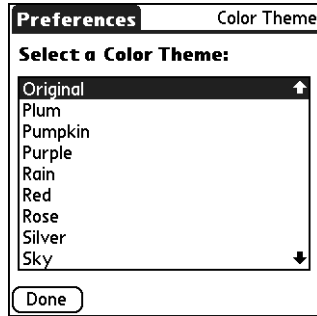
The new colors immediately appear on the screen. You can scroll through the various color selections until you find the one you want to use.



2. Press Function  + Enter , or tap Done.

## Owner preferences

The Owner Preferences screen enables you to record a name, company name, phone number, or any other information that you want to associate with your handheld. This information can be from the business card created during installation.

If you use the Security Preferences screen to turn off and lock your handheld with a password, the first three lines in the Owner preferences screen appear the next time you turn on your handheld.

**To enter the Owner preferences:**

- Enter the text that you want to associate with your handheld in the Owner Preferences screen. If you enter more text than can fit on one screen, a scroll bar automatically appears on the right side of the screen.

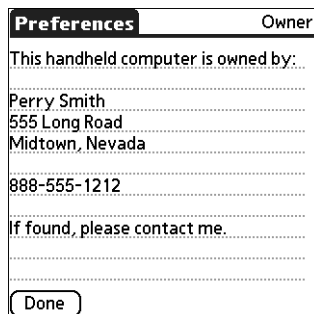



If you assign a password with the Security Preferences screen, the information in the Owner Preferences screen cannot be changed. In this case, an Unlock button appears at the bottom of the screen.

To unlock the Owner Preferences screen:

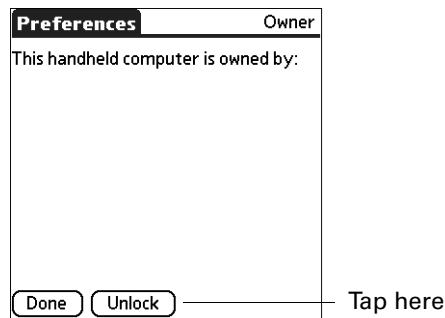
1. Tap Unlock.



2. Enter the password that you defined in the Security Preferences screen.
3. Press Function  + Enter , or tap OK.

## Security preferences

Your handheld comes with a security feature so that unauthorized users cannot view the entries you want to protect. Use the security feature to do the following:

- Lock and turn off your handheld so that it does not operate until you enter the correct password.
- Mask all records that you mark as private so that the information appears grayed out.
- Hide all records that you mark as private so they do not appear on any screen.
- Encrypt records.

You can mask and hide private records with or without a password. Without a password, private records are hidden or masked until you set the Security preference to show them. With a password, you must enter the password to view the private entries.





### Assigning a password

You can assign a password to protect your private records and to lock your handheld. You can mask the password from accidental viewing. To quickly log in, you can also assign a short, quick password that works only at your first login attempt and for a limited amount of time. You can set the amount of time you need to enter the quick password.

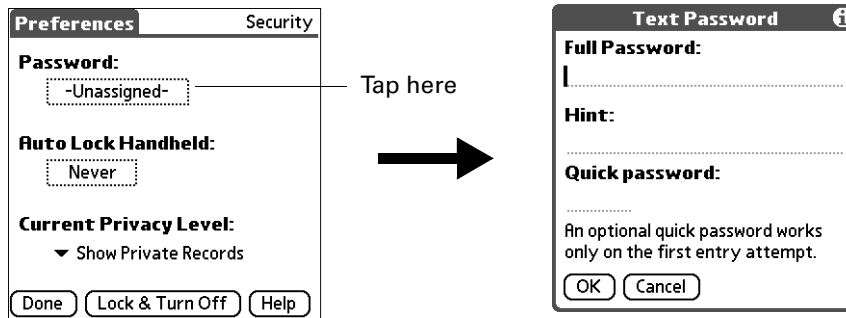
To assign a password:

1. Tap the Password box.



2. Enter a password.
3. Enter a hint to help you remember your password if you forget it. This is optional.
4. Enter a quick password. This is optional.
5. Press Function  + Enter , or tap OK.
6. Enter the *same* password a second time, and press Function  + Enter , or tap OK.



### Changing or deleting a password

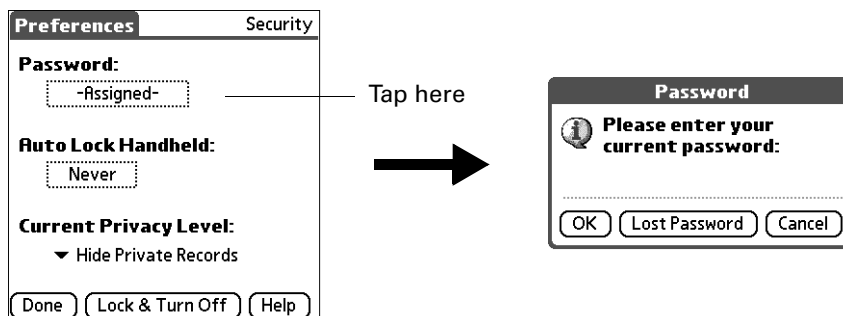

Once you define a password for your handheld, you can change or delete it at any time. You must enter the current password before you can change or delete it.

To change or delete your password:

1. Tap the Password box.
2. Enter the current password.



3. Press Function  + Enter , or tap OK.



4. Do one of the following:
  - To change the password, hint, or quick password, enter the new information, and press Function  + Enter , or tap OK.
  - To remove the password, tap Unassign.





### Masking your password entry

Masking your password entry secures your password against accidental viewing by another person. The password only shows asterisks as you are entering the characters.

#### To mask your password entry:

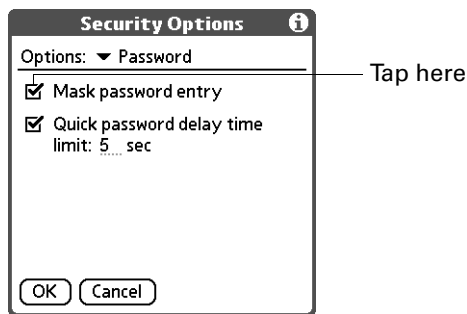
1. Press Function  + Menu , and then select Security Options.
2. Tap the check box for Mask password entry.





3. Press Function  + Enter , or tap OK.

**NOTE** Turn off and then turn on your handheld to enable this change.



### Setting the quick password delay time limit

You can set a quick password delay time limit to accommodate your personal preference. After the delay limit has been reached, you must enter the full password. For more information about the quick password, see [“Changing or deleting a password”](#) earlier in this chapter.

To set the quick password delay time limit:

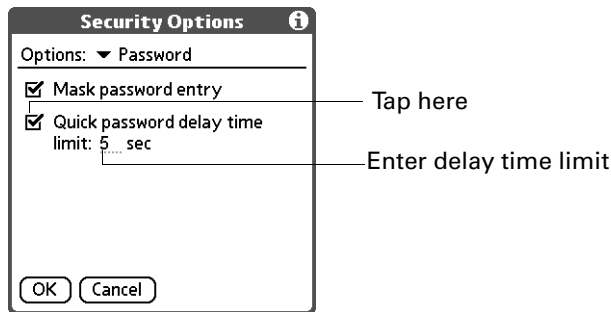
1. Press Function  + Menu , and then select Security Options.
2. Tap the check box for Quick password delay time limit.



3. Press Function  + Enter , or tap OK.

**NOTE** You need to turn off and then turn on your handheld before this change is enabled.

### Locking your handheld

You can lock your handheld so that it cannot be operated until your password is entered. In the event that your handheld is lost or stolen, this helps protect your data from unauthorized use. You can set your handheld to lock automatically, or you can lock it manually.

#### Locking your handheld automatically

You can set your handheld to lock automatically when any one of the following occurs:

- When you turn off the power
- At a time you specify
- After a period of inactivity you specify

**To set your handheld to lock when you turn it off:**

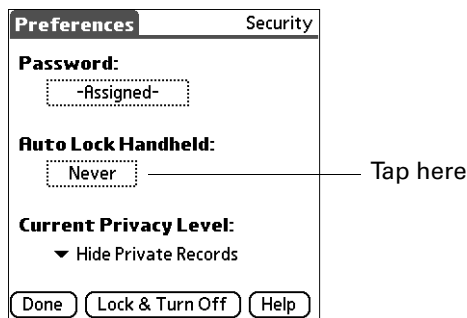

1. Tap the Auto Lock Handheld box.

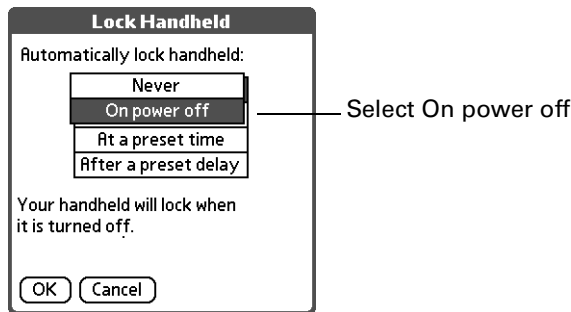

2. Enter your password.

3. Select On power off.



4. Press Function  + Enter , or tap OK.

**NOTE** Turn off and then turn on your handheld to enable this change.

**To set your handheld to lock at a preset time:**

1. Tap the Auto Lock Handheld box.

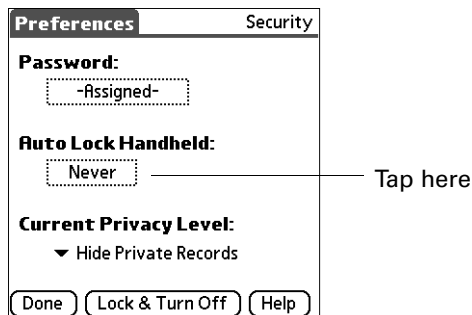



2. Enter your password.

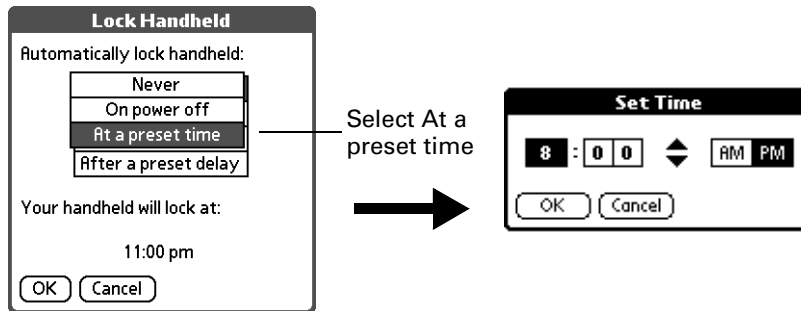

3. Select At a preset time, and then use the arrows to set the time.



4. Press Function  + Enter , or tap OK.

**NOTE** Turn off and then turn on your handheld to enable this change.

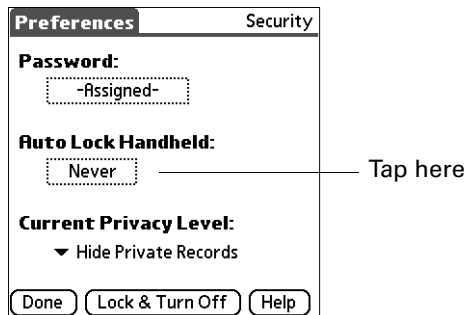

To set your handheld to lock after a period of inactivity:

1. Tap the Auto Lock Handheld box.

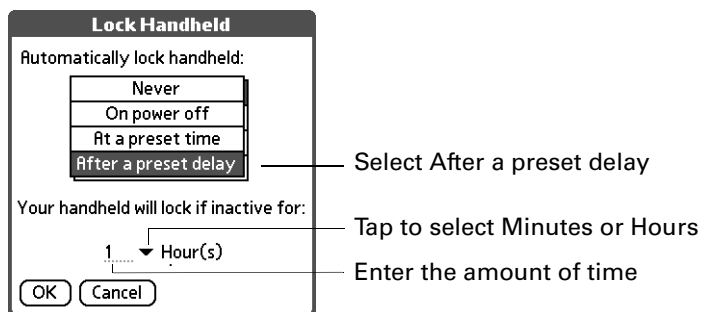

2. Enter your password.
3. Select After a preset delay.



4. Enter the inactive period, and then select Minute(s) or Hour(s) from the pick list.
5. Press Function  + Enter , or tap OK.

**NOTE** You need to turn off and then turn on your handheld before this change is enabled.

---

**IMPORTANT** If you lock your handheld, you must enter the exact password to reactivate your handheld. If you forget the password, your handheld will present the hint you have entered to help you remember the password. If you still cannot remember the password, you must perform a hard reset to resume using your handheld. Performing a hard reset deletes all the records in your handheld; however, you can restore all synchronized data at the next HotSync operation. See [“Performing a hard reset”](#) in [Appendix A](#) for more information.

---

### Locking your handheld manually

You can turn off and lock your handheld manually.

To lock and turn off your handheld:

1. Tap Lock & Turn Off.

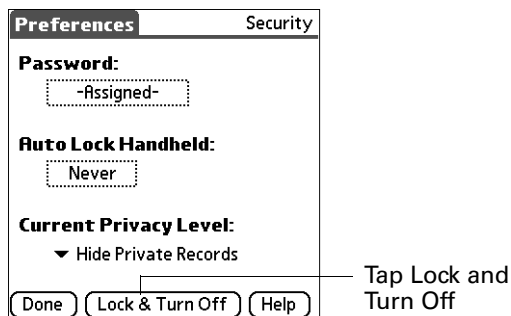

2. To use your handheld, turn it on and then enter the password.

### Recovering from a forgotten password

---

**IMPORTANT** Deleting a forgotten password also deletes all entries and files marked as Private.

---

If you are not locked out of your handheld and you forgot your password, your handheld displays a hint, if you entered one, to help you remember the password. If you are still unable to remember the password, you can delete it from your handheld.

---

**IMPORTANT** If you synchronize with your computer before deleting a forgotten password, your handheld restores your private entries the next time you perform a HotSync operation, but it does not restore the password.

---

If you locked your handheld, you must enter the exact password to reactivate your handheld. If you forget the password, your handheld will present the hint you have entered to help you remember the password.

If you still cannot remember the password, you must perform a hard reset to resume using your handheld. Performing a hard reset deletes all the records in your handheld; however, you can restore all synchronized data at the next HotSync operation. See [“Performing a hard reset”](#) in [Appendix A](#) for more information.

**To delete a forgotten password:**

1. Tap the Password box.
2. Tap Lost Password.

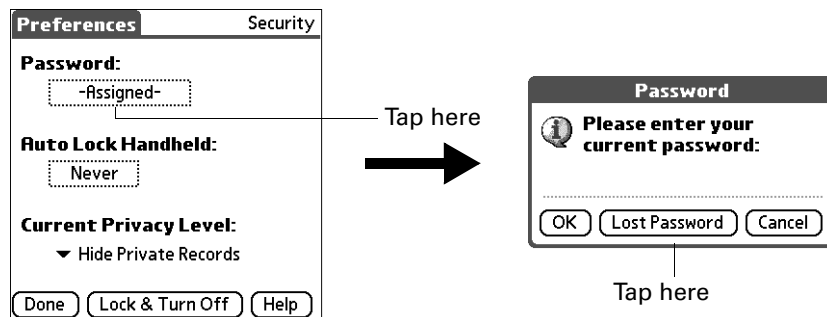

3. Tap Delete Password.

### Making records private

In many applications, you can make individual records private. Private records remain visible and accessible, however, until you select the Security setting to hide or mask all private records.

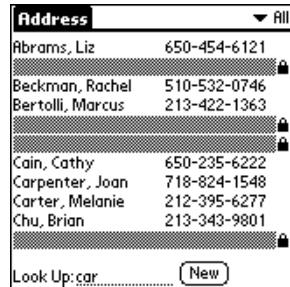

Masked records appear as gray placeholders in the same position they would appear if they were not masked, and are marked with a lock icon. Hidden records disappear completely from the screen. If you define a password for your handheld, you must enter it to display private records.

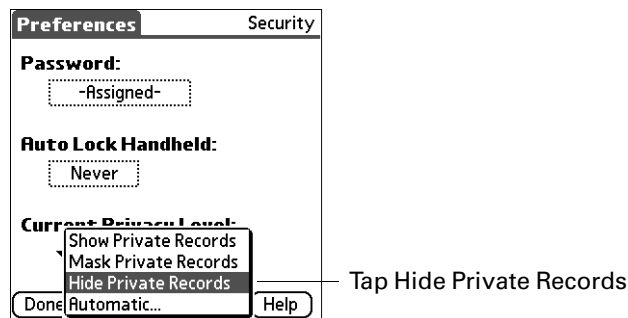

**To hide all private records:**

1. Tap the Current Privacy pick list and select Hide Private Records.





2. Press Function  + Enter , or tap OK to confirm that you want to hide private records.

**To mask all private records:**

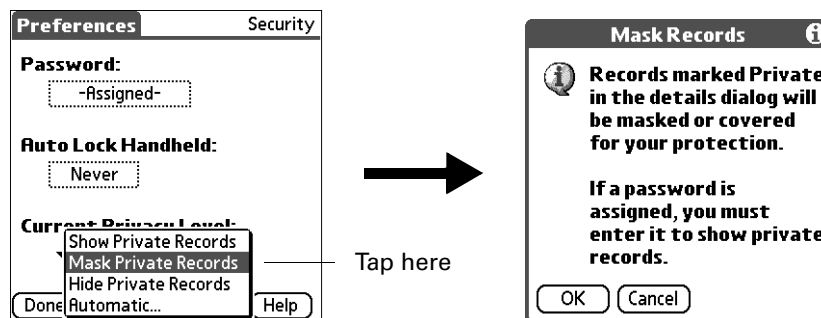
1. Tap the Current Privacy pick list and select Mask Records.





2. Press Function  + Enter , or tap OK to confirm that you want to mask private records.

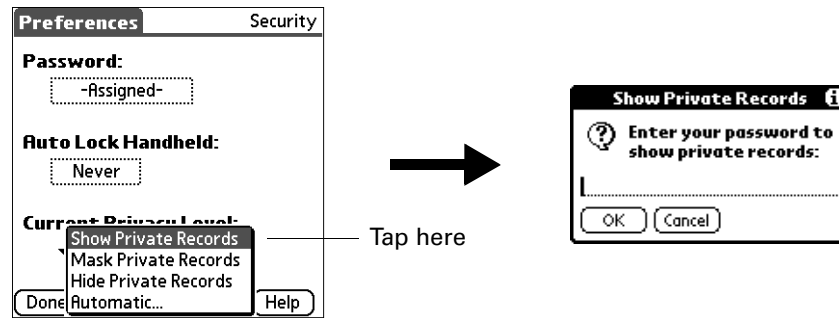

**To display all private records:**

1. Do one of the following:
  - Tap the Current Privacy pick list and select Show Private Records.
  - If you do not have a password, hidden and masked records become visible. If you have a password, the Show Private Records dialog box appears. Go to step 2.





2. Enter your password.
3. Press Function  + Enter , or tap OK.

**To unmask individual records:**

1. Select a masked record.
2. Do one of the following:
  - If you do not have a password, a masked record becomes visible.
  - If you have a password, the Show Private Records dialog box appears. Go to step 3.
3. Enter your password.
4. Press Function  + Enter , or tap OK.

**To make a record private:**

1. Display the entry that you want to make private.
2. Tap Details.
3. Tap the Private check box.
4. Press Function  + Enter , or tap OK.

### Hiding or masking your private records automatically

You can set your handheld to automatically hide or mask your private records when any one of the following occur:

- When you turn off the power
- At a time you specify
- After a period of inactivity you specify

To hide or mask your records when you turn your handheld off:

1. Select Automatic.

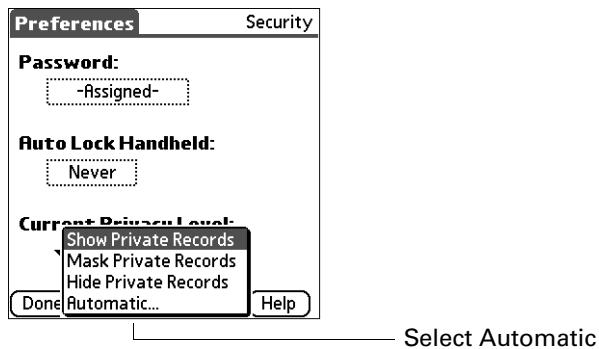

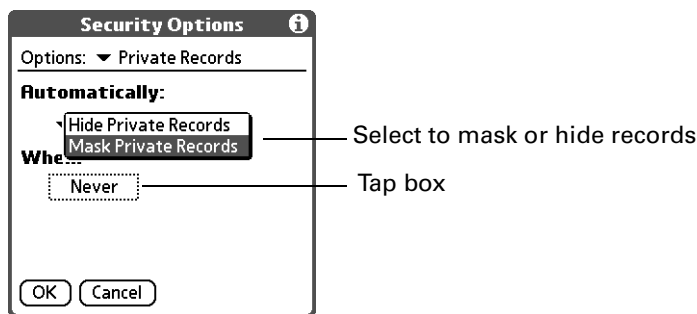

2. Tap the Automatically pick list and select either Mask Private Records or Hide Public Records.

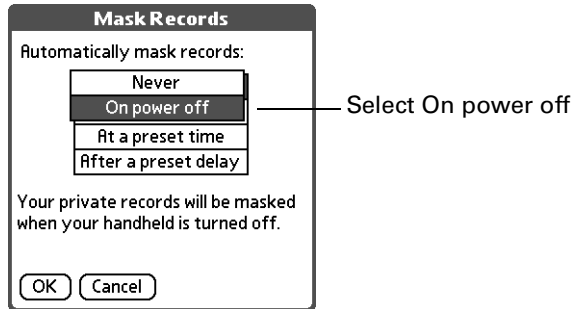

3. Tap When box.

4. Select On power off.



5. Press Function  + Enter , or tap OK.

**NOTE** Turn off and then turn on your handheld to enable this change.

To automatically hide or mask records at a preset time:

1. Select Automatic.

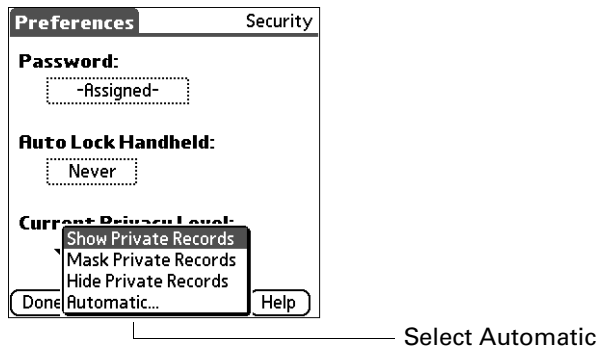

2. Tap the Automatically pick list and select either Mask Private Records or Hide Public Records.

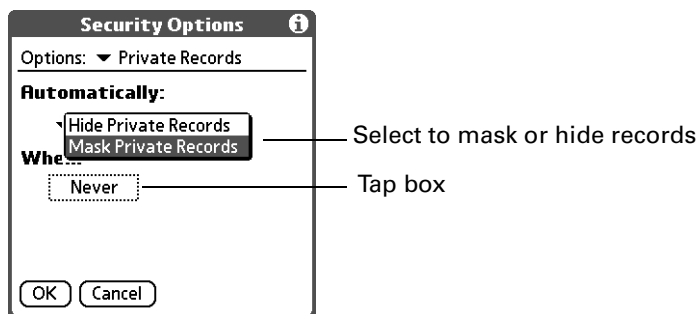

3. Tap When box.

4. Select At a preset time, and then use the arrows to set the time.

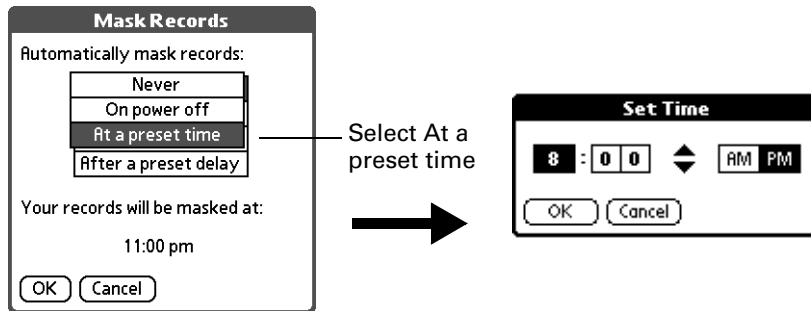

5. Press Function + Enter , or tap OK.

**NOTE** Turn off and then turn on your handheld to enable this change.

To automatically hide or mask your records after a period of inactivity:

1. Select Automatic.

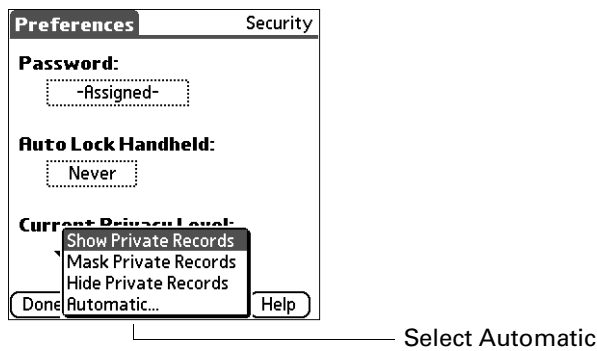

2. Tap the Automatically pick list and select either Mask Private Records or Hide Public Records.

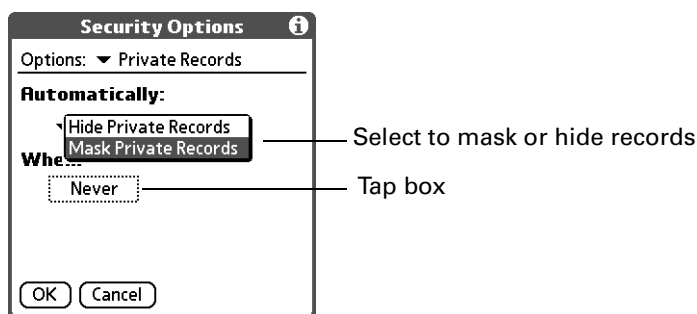

3. Tap When box.



4. Select After a preset delay.

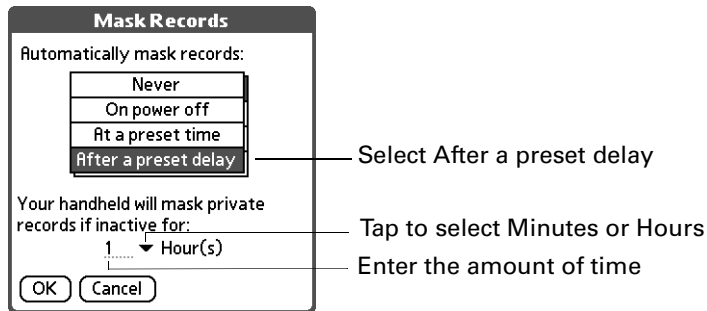

5. Enter the inactive period, and then select Minute(s) or Hour(s) from the pick list.
6. Press Function  + Enter , or tap OK.



**NOTE** Turn off and then turn on your handheld to enable this change.

### Encrypting your data

You can encrypt selected data whenever your handheld locks. The more applications and data that are selected, the longer the encryption process.

When you unlock the handheld and enter a valid password, the encrypted data is decrypted. The more applications and data that are selected for encryption, the longer the decryption process.

#### To encrypt your data when the handheld locks:

1. Press Function  + Menu , and then select Security Options.
2. Tap the Options pick list and select Encryption.
3. Tap the check box for Encrypt data when locked.

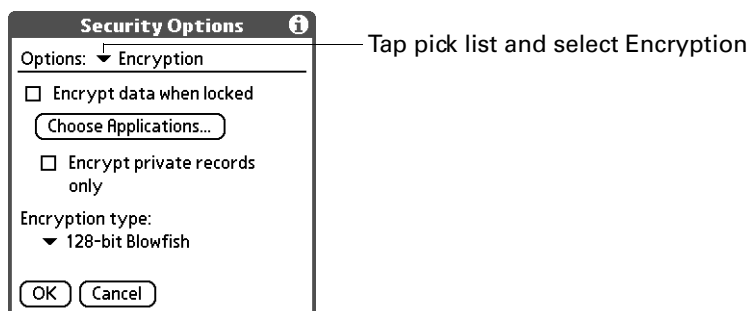

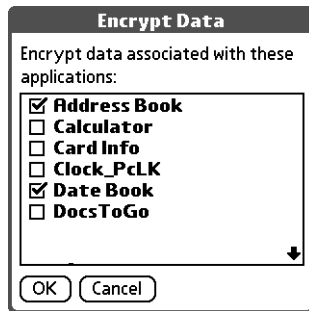

4. Tap the Choose Applications button.

5. Select the applications whose data you want to encrypt.

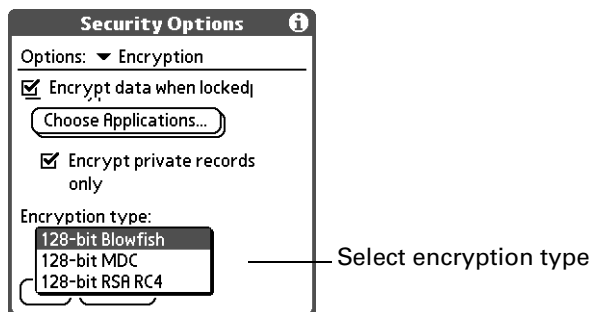

6. If you want to encrypt only private records, select Encrypt private records only.
7. Tap the Encryption type pick list and select a type.





8. Press Function  + Enter , or tap OK.

### Using security shortcuts

You can create shortcuts to activate certain security features, such as locking the handheld or masking private records. For information on using shortcuts, see “Using ShortCuts” in [Chapter 3](#).

To create and activate security shortcuts:

1. Press Function  + Menu , and then select Security Options.
2. Select Shortcuts from the Options pick list.
3. Tap the check box for the security shortcut you want to activate.

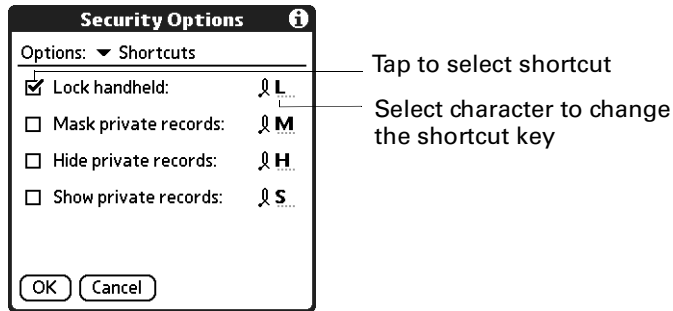

4. If you want to change the current character, tap and drag the stylus to select the character, and type the new character.

## ShortCuts preferences

The ShortCuts Preferences screen enables you to define abbreviations for entering text. This section describes how to create, edit, and delete a ShortCut.

### Creating a ShortCut

You can create a ShortCut for any words, letters, or numbers. All ShortCuts you create appear on the list in the ShortCut Preferences screen. All the ShortCuts are available in any of your handheld applications and are backed up on your computer when you perform a HotSync operation.



To create a ShortCut:

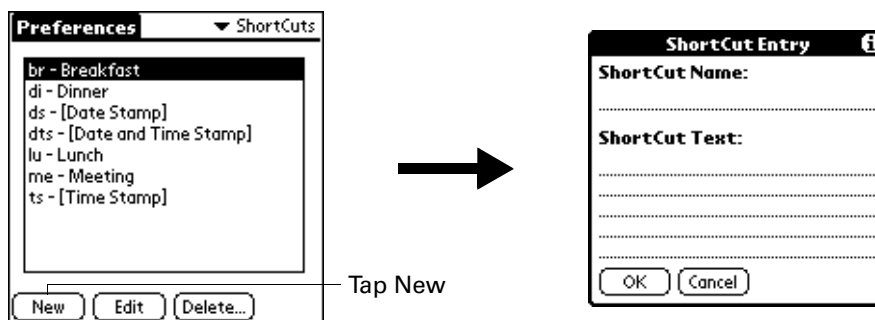

1. Tap New.
2. On the ShortCut Name line, enter the letters you want to use to activate the ShortCut.



3. Select the ShortCut Text area and enter the text that you want to appear when you write the ShortCut characters.

**TIP** You may want to add a space (space character) after the last word in your ShortCut text. This way, a space automatically follows the ShortCut text.

4. Press Function  + Enter , or tap OK.

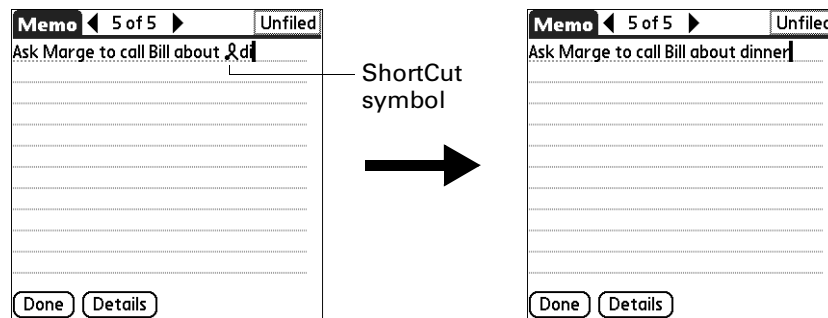

To use a ShortCut, press Press Function  + ShortCut  followed by the ShortCut characters. The ShortCut symbol appears at the insertion point to show that you are in ShortCut mode.



### Editing a ShortCut

After you create a ShortCut, you can modify it at any time.



#### To edit a ShortCut:

1. Tap the ShortCut you want to edit.
2. Tap Edit.
3. Make the changes you want.
4. Press Function  + Enter , or tap OK.

### Deleting a ShortCut

If you no longer need a ShortCut, you can delete it from the list of ShortCuts.

#### To delete a ShortCut:

1. Tap the ShortCut you want to delete.
2. Tap Delete.
3. Press Function  + Enter , or tap Yes.

# Maintaining Your Handheld

This appendix provides information on the following:

- Taking proper care of your handheld
- Prolonging battery life
- Resetting your handheld
- Removing and installing your SIM card

## Caring for your handheld

Your handheld is designed to be rugged and reliable and to provide years of trouble-free service. Please observe the following general tips when using your handheld:

- Take care not to scratch the screen of your handheld. Keep the screen clean. When working with your handheld, use the supplied stylus or plastic-tipped pens intended for use with a touch-sensitive screen. Never use an actual pen or pencil or other sharp object on the surface of the handheld screen.
- Your handheld is not waterproof and should not be exposed to rain or moisture. Under extreme conditions, water may enter the circuitry through the front panel buttons. In general, treat your handheld as you would a pocket calculator or other small electronic instrument.
- Take care not to drop your handheld or subject it to any strong impact. Do not carry your handheld in your back pocket: if you sit on it, you may damage it.
- Protect your handheld from temperature extremes. For example, do not leave your handheld on the dashboard of a car on a hot day or on a day when temperatures are below freezing, and keep it away from heaters and other heat sources.
- Do not store or use your handheld in any location that is extremely dusty, damp, or wet.
- Use a soft, damp cloth to clean your handheld. If the surface of the handheld screen becomes soiled, clean it with a soft cloth moistened with a diluted window-cleaning solution.

## Battery considerations

Please note the following considerations for the battery in your handheld:

- Under normal conditions, you can keep your handheld battery charged by placing it in the cradle between 15 to 30 minutes each day. You can conserve battery life by changing the Auto-off setting that automatically turns the handheld off after a period of inactivity and by selecting the Conserve power option in the Wi-Fi preferences. See “[Auto-off delay](#)” in [Chapter 18](#) and see “[Wi-Fi preferences](#)” in [Chapter 18](#) for more information.
- If the battery becomes low in the course of normal use, an alert appears on the handheld screen describing the low battery condition. If this alert appears, perform a HotSync® operation to back up your data; then leave your handheld in the cradle to recharge the unit. This helps prevent accidental data loss.
- If the battery becomes too low, the wireless operations are disabled to save battery strength.
- If the battery drains to the point where your handheld does not operate, it stores your data safely for about five days. In this case, there is enough residual energy in the battery to store the data, but not enough to turn on your handheld. If your handheld does not turn on when you press the power button, you should recharge the unit immediately. The battery may not have enough residual energy to power the indicator light, which normally displays green when charging.
- If your battery drains and you have the unit in an uncharged state for an extended period of time, you can lose all of the stored data.
- There are no serviceable parts inside your handheld, so do not attempt to open the unit.
- If you ever dispose of your handheld, please dispose of it without damaging the environment. Take your handheld to your nearest environmental recycling center.

## Resetting your handheld

Under normal circumstances, you will not have to use the reset button. On rare occasions, however, your handheld may no longer respond to buttons or to the screen. In this case, you need to perform a reset to get your handheld running again.

### Performing a soft reset

A soft reset tells your handheld to stop what it’s doing and start over again. All records and entries stored in your handheld are retained with a soft reset. After a soft reset, the Welcome screen appears, followed by the Date and Time Preferences screen (to set the date and the time).

**To perform a soft reset:**

- Use the reset tip tool, or the tip of an unfolded paper clip (or similar object *without* a sharp tip), to gently press the reset button inside the hole on the back panel of your handheld.

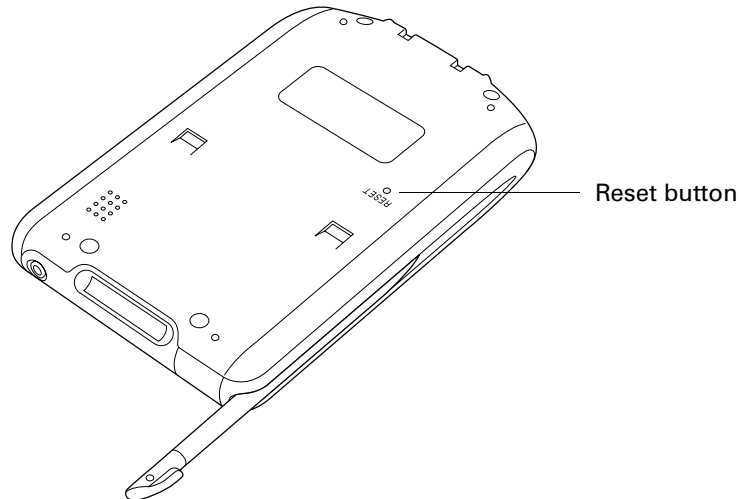

**TIP** The metal and plastic stylus that comes with your handheld has a reset tip inside. To use it, unscrew the barrel from the stylus quill.

## Performing a hard reset

With a hard reset, all records and entries stored in your handheld are erased. Never perform a hard reset unless a soft reset does not solve your problem.

**NOTE** You can restore any data previously synchronized with your computer during the next HotSync operation.

**To perform a hard reset:**

1. Hold down the power button on the front panel of the handheld.
2. While holding down the power button, use the reset tip tool, or the tip of an unfolded paper clip (or similar object *without* a sharp tip), to gently press and release the reset button.
3. Wait for the Palm Powered™ logo to appear; then release the power button.
4. When a message appears on the handheld screen warning that you are about to erase all the data stored on your handheld, do one of the following:
  - Press Up on the navigator to complete the hard reset and display the Digitizer screen.
  - Press any application button to perform a soft reset. (Pressing a keyboard key has no effect.)

**NOTE** With a hard reset, the current date and time are retained. Formats preferences and other settings are restored to their factory default settings.

**To restore your data from a Windows computer after a hard reset:**

1. Click the HotSync icon  in the Windows system tray (lower-right corner of the taskbar).

You can also click the HotSync command on the Palm™ Desktop software menu bar.

2. From the HotSync Manager menu, select Custom.
3. Select the appropriate username from the list.
4. Select an application in the Conduit list.
5. Click Change, and select Desktop overwrites the handheld.

**NOTE** Changing the HotSync setting from the default affects only the next HotSync operation. Thereafter, the HotSync Actions revert to their default settings. To use a new setting on an ongoing basis, select the Set As Default box. Then whatever you selected as the default setting is used when you click the Default button in the Custom dialog box.



6. Click OK.
7. Repeat steps 4 through 6 to change conduit settings for other applications.
8. Click Done to activate your settings.
9. Perform a HotSync operation.



To restore your data from a Mac computer after a hard reset:

1. Double-click the HotSync Manager in the Palm folder.
2. From the HotSync menu, choose Conduit Settings.

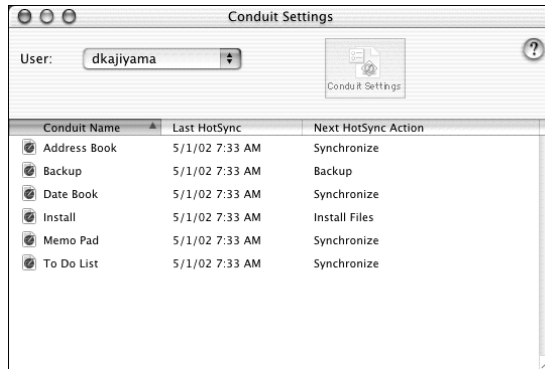

3. From the Users pop-up menu, select the appropriate username.
4. Select an application from the list.
5. Click Conduit Settings.

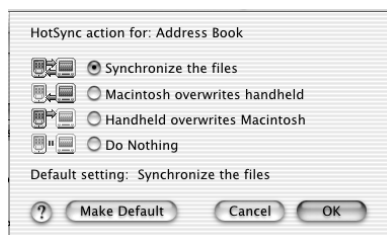

6. Click Macintosh overwrites handheld.

**NOTE** Changing the HotSync setting from the default affects only the next HotSync operation. Thereafter, the HotSync Actions revert to their default settings. To use a new setting on an ongoing basis, click Make Default. Then whatever you selected as the default setting is used for HotSync operations.

7. Click OK.
8. Repeat steps 4 through 7 to change conduit settings for other applications.
9. Close the Conduit Settings window.
10. Perform a HotSync operation.



## Frequently Asked Questions

If you encounter a problem with your handheld, do not call technical support until you have reviewed the frequently asked questions in this appendix and you have also reviewed the following:

- This handbook
- The *Palm™ Tungsten™ C Read This First* guide that came with your handheld
- The Readme file located in the folder where you installed the Palm™ Desktop software on your Windows computer or on your installation CD for Mac users
- The Palm Desktop online Help
- The *Palm™ Desktop Software for the Macintosh User's Guide*, located in the Documentation folder on your installation CD
- The Palm Knowledge Library, accessible at [www.palm.com/support/tungstenc](http://www.palm.com/support/tungstenc) in the Support section
- The most recent Palm™ Tungsten™ C handheld HelpNotes on your regional web site

If you are still having problems, contact technical support. See the Customer Support card that comes with your handheld, or go to [www.palm.com/support/tungstenc](http://www.palm.com/support/tungstenc).

There are a variety of third-party applications available for your handheld. To learn more about these applications, go to the web site: [www.palm.com](http://www.palm.com).

**NOTE** Palm works with developers of third-party add-on applications to ensure the compatibility of these applications with your new Palm handheld. Some third-party applications, however, may not have been upgraded to be compatible with your new Palm handheld. If you suspect that a third-party application is adversely affecting the operation of your handheld, contact the developer of the application."

## Software installation problems

<b>Problem</b>	<b>Solution</b>
The installation menu did not appear when I inserted the Desktop Software CD-ROM (or the Software Essentials CD-ROM) into my Windows computer.	Try the following: <ol style="list-style-type: none"><li>1. From the Windows desktop, click Start.</li><li>2. Select Run.</li><li>3. Click Browse.</li><li>4. Locate your CD-ROM drive and select the Autorun file.</li><li>5. Click Open.</li><li>6. Click OK.</li></ol>
I cannot install Palm Desktop software on my Windows computer.	Try the following: <ol style="list-style-type: none"><li>1. Disable any virus-scanning software on your computer.</li><li>2. Close any open applications.</li><li>3. Make sure your computer has at least 50MB of disk space available.</li><li>4. Delete all temporary files.</li><li>5. Run ScanDisk (or another disk verification tool) on your computer.</li><li>6. Uninstall and then reinstall Palm Desktop software.</li></ol>
I cannot install Palm Desktop software on my Mac computer.	Try the following: <ol style="list-style-type: none"><li>1. Disable any virus-scanning software on your computer.</li><li>2. Quit any open applications.</li><li>3. Make sure your computer has at least 50MB of disk space available.</li><li>4. Uninstall and then reinstall Palm Desktop software.</li><li>5. If you are using Mac OS X, you must install using an account with Administrator privileges.</li></ol>

My files didn't install during a HotSync operation.	If files do not install after you perform a HotSync operation the file type was not recognized. Try launching the associated application from your handheld and then performing another HotSync operation. If the files still remain in the list, they are not associated with an application on your handheld and cannot be installed.
I can't add more files to the Palm Quick Install list.	Make sure the dialog box that confirms where the files will be installed is closed. You cannot add more files to the list when the confirmation dialog box is open. For details, see <a href="#">"Installing applications and files on a Windows computer"</a> in <a href="#">Chapter 4</a> .



## Operating problems

### Problem

I don't see anything on my handheld's screen.

### Solution

Try each of these in turn:

- Press an application button to ensure that your handheld is turned on.
- Press Function  + Brightness . If the Brightness dialog box appears, adjust the brightness by holding down the up scroll button for a few seconds. If this doesn't work, hold the down scroll button for a few seconds.
- If your handheld was exposed to cold, make sure it is at room temperature.
- Recharge the unit.
- Perform a soft reset. If your handheld still doesn't turn on, perform a hard reset. See ["Resetting your handheld"](#) in [Appendix A](#).

---

**IMPORTANT** With a hard reset, all records and entries stored in your handheld are erased. Never perform a hard reset unless a soft reset does not solve your problem. You can restore any data previously synchronized with your computer during the next HotSync® operation.



---

My battery doesn't charge.

- Make sure the power outlet is active and the HotSync cradle is properly plugged in.
- If the battery does not hold a charge, return your handheld to an authorized Palm service center.

- I get a warning message telling me my handheld memory is full.
- Try each of these in turn:
- Purge records from Date Book and To Do List. This deletes To Do List items and past Date Book events from the memory of your handheld. See [“Purging records”](#) in [Chapter 4](#). You may need to perform a HotSync operation to recover the memory.
  - Delete unused memos and records. If necessary, you can save these records. See [“Deleting records”](#) in [Chapter 4](#).
  - If you have installed additional applications on your handheld, remove them to recover memory. See [“Removing applications”](#) in [Chapter 4](#).
- My handheld keeps turning itself off.
- Your handheld is designed to turn itself off after a period of inactivity. This period can be set at one, two, or three minutes. Check the Auto-off setting. See [“Auto-off delay”](#) in [Chapter 18](#).
- My handheld is not making any sounds.
- Check the System, Alarm, and Game Sound settings. See [“System, alarm, and game sounds”](#) in [Chapter 18](#).
- My handheld’s indicator light is not blinking when alarms occur.
- Check the Alarm LED setting. See [“Alarm Vibrate and indicator light settings”](#) in [Chapter 18](#).
- My handheld does not vibrate when alarms occur.
- Check the Alarm Vibrate setting. See [“Alarm Vibrate and indicator light settings”](#) in [Chapter 18](#).
- My handheld has frozen.
- Perform a soft reset. See [“Resetting your handheld”](#) in [Appendix A](#).
- My handheld has frozen.
- If a network connection was improperly terminated, your handheld may appear to be frozen for up to 30 seconds. If it is still frozen after 30 seconds, perform a soft reset. See [“Performing a soft reset”](#) in [Appendix A](#).
  - If your handheld is near your computer, move your handheld away from the computer’s infrared port.

## Tapping and writing problems

<b>Problem</b>	<b>Solution</b>
When I tap the buttons or screen icons, my handheld activates the wrong feature.	Calibrate the screen. See <a href="#">“Digitizer preferences”</a> in <a href="#">Chapter 18</a> .
When I tap the buttons nothing happens.	If you have enabled Writing Area, you need to tap and hold the button or other onscreen control until it activates. This delay keeps the handheld activating a control while you are writing a Graffiti 2 character.
When I press Function  + Menu  , or tap the Menu bar nothing happens.	Not all applications or screens have menus. Try changing to a different application.
I can't get my handheld to recognize my handwriting.	<ul style="list-style-type: none"> <li>■ Make sure you have turned on Writing Area. See <a href="#">“Writing Area preferences”</a> in <a href="#">Chapter 18</a>.</li> <li>■ For your handheld to recognize handwriting input with the stylus, you need to use Graffiti 2 writing. See <a href="#">“Using Graffiti 2 writing to enter data”</a> in <a href="#">Chapter 3</a>.</li> <li>■ Write Graffiti 2 strokes for letters on the left side and the strokes for numbers on the right side of the screen.</li> <li>■ Make sure that Graffiti 2 is not shifted into extended or punctuation modes. See <a href="#">“Using Graffiti 2 writing to enter data”</a> in <a href="#">Chapter 3</a>.</li> <li>■ See <a href="#">“Graffiti 2 tips”</a> in <a href="#">Chapter 3</a> for tips on increasing your accuracy when you write Graffiti 2 characters.</li> </ul>

## Application problems

<b>Problem</b>	<b>Solution</b>
I tapped the Today button, but it does not show the correct date.	Your handheld is not set to the current date. Make sure the Set Date box in the Date and Time Preferences screen displays the current date. See <a href="#">“Date and Time preferences”</a> in <a href="#">Chapter 18</a> for more information.

I know I entered some records, but they do not appear in the application.

Try each of these in turn:

- Check the Categories pick list (upper-right corner). Choose All to display all of the records for the application.
- Check Security and confirm that Private Records is set to Show private records.
- In To Do List, tap Show and see if Show Only Due Items is selected.

I am having problems listing memos the way I want to see them.

Try each of these in turn:

- If you cannot manually arrange the order of the memos in the list screen, check the Memo Preferences setting. Make sure that Sort by is set to Manual.
- If you choose to view your memos alphabetically on Palm Desktop software and then perform a HotSync operation, the memos on your handheld still appear in the order defined in the Memo Preferences setting. In other words, the sort settings you use with Palm Desktop software *are not* transferred to your handheld.

I created an event in Date Book, but it doesn't appear in the Week view.

If you have two or more events with the same start time, the first event created appears as a gray bar, and any subsequent conflicting events appear as a single red bar. To see the overlapping events select the Day View.



My vCard or vCal e-mail attachment isn't forwarding correctly.

Palm Desktop software provides several features that interact with e-mail client software on a Windows computer. In order for these features to work correctly, the e-mail client software must be properly configured. Follow these steps to check the configuration:

1. Click the Windows Start menu, and then select Settings.
2. Select Control Panel.
3. Select Internet Options, and then click the Programs tab.
4. Make sure that the E-mail field is set to the correct e-mail client software.
5. Click OK.
6. Start the e-mail client software and make sure it is configured as the default MAPI client. Consult the documentation for your desktop e-mail application for more information.



## HotSync problems

<b>Problem</b>	<b>Solution</b>
<p>I cannot perform a HotSync operation. What should I check to make sure I am doing it correctly?</p>	<ul style="list-style-type: none"> <li>■ Make sure the HotSync cradle is connected securely.</li> </ul> <p>On a Windows computer try these steps:</p> <ol style="list-style-type: none"> <li>1. Check the Windows system tray to make sure the HotSync Manager is running. If it is not, open Palm Desktop software.</li> <li>2. Make sure you selected Local USB or Local Serial, as appropriate, from the HotSync Manager menu.</li> <li>3. If you are using the serial cradle, make sure you selected the correct serial port on the Local tab in the Setup dialog box. It should be set to the port where you connected the HotSync cradle.</li> </ol> <p>On a Mac computer, try the following:</p> <ul style="list-style-type: none"> <li>■ Make sure HotSync Manager is enabled. If it is not, double-click the HotSync Manager icon  in the Palm folder and enable HotSync Manager on the HotSync Controls tab.</li> </ul>
<p>I can't perform a network HotSync operation using my wireless LAN.</p>	<ul style="list-style-type: none"> <li>■ Make sure you are connected to your wireless LAN by checking your Signal Status. This can be found within the Wi-Fi Preferences or from the command bar. See <a href="#">“Turning the 802.11b radio on and off”</a> in <a href="#">Chapter 18</a>.</li> <li>■ Make sure the PC selected for Network HotSync is your PC. See <a href="#">“Performing a wireless network HotSync operation”</a> in <a href="#">Chapter 17</a>.</li> </ul>
<p>I can't find my PC while attempting a network HotSync operation.</p>	<p>You can enter your computer name manually by tapping Other within Network HotSync setup and enter your PC's name or IP address. To find the name or IP address of your PC, consult with your network administrator or your computer documentation for instructions. For more information about manually adding a PC, see <a href="#">“Performing a wireless network HotSync operation”</a> in <a href="#">Chapter 17</a>.</p>
<p>I performed a HotSync operation, but one of my applications did not synchronize.</p>	<ul style="list-style-type: none"> <li>■ On a Windows computer, click the HotSync Manager and choose Custom. Check that the correct conduit is active.</li> <li>■ On a Mac computer, double-click the HotSync Manager icon . From the HotSync menu, choose Conduit Settings. Select your username from the User pop-up menu, and check that the correct conduit is active.</li> </ul>

I am using Outlook as my PIM, but I cannot do a HotSync operation.

Try each of these in turn:

- Click the HotSync Manager and select Custom. Check that the correct conduit is active.
- Check that the correct conduit is installed. Reinstall the HotSync Manager and make sure that the correct conduit is selected.
- Reinstall Palm Desktop software and select the option to synchronize with Microsoft Outlook.

I cannot launch the HotSync Manager.

- If you are using the optional serial cradle, make sure you are not running another program, such as America Online, that uses the serial port you selected in the Setup dialog box.
- Make a backup copy of your Palm Desktop data, and then reinstall Palm Desktop software.

I tried to perform a local HotSync operation, but it did not complete successfully.

Try each of these in turn:

- Make sure your handheld is seated in the cradle/cable correctly.
- Check the connection between the HotSync cradle/cable and the USB or serial port on your computer.
- Make sure the user name you selected in Palm Desktop software matches the user name assigned to your handheld.
- Make sure the date on your computer matches the date on your handheld.
- Read the HotSync Log for the user account for which you are performing a HotSync operation

On a Windows computer, try each step in turn:

- Make sure that HotSync Manager is running. If it is running, close it and restart it.
- Make sure you selected Local USB or Local Serial, as appropriate, from the HotSync Manager menu.
- If you are using the serial cradle/cable, make sure you selected the correct serial port on the Local tab in the Setup dialog box. It should be set to the port where you connected the HotSync cradle/cable.

I tried to perform a local HotSync operation, but it did not complete successfully  
(Continued)

- If you are using the serial cradle/cable, try a lower baud rate setting on the Local tab in the Setup dialog box.
- If you are using the serial cradle/cable, make sure you aren't running a program, such as America Online, that uses the serial port you selected in the Setup dialog box.

On a Mac computer, try each step in turn:

- Make sure HotSync Manager is enabled on the HotSync Controls tab in the HotSync Software Setup window.
- If you are using the optional serial cradle/cable, double-click the HotSync Manager icon in the Palm folder and then click the Connection Settings tab. Make sure the port selection matches the port where your HotSync cradle/cable is attached.
- If you are using the optional serial cradle/cable, try a lower Speed setting on the Connection Settings tab.
- If you are using the optional serial cradle/cable, make sure you aren't running a program, such as America Online, fax or telephony software, or AppleTalk networking, that uses the serial port you selected in the Connection Settings tab.



I can't perform an IR HotSync operation.

Try each of these in turn:

- On a computer running Windows 98, be sure that the HotSync Manager is running, that Infrared is selected on the HotSync Manager menu, and that the Serial Port for local operations is set to the simulated port for infrared communication. See [“Conducting IR HotSync operations”](#) in [Chapter 17](#) for details.
- On a computer running Windows 2000/ME/XP, select IR in the HotSync Manager. See [“Preparing your computer for infrared communication”](#) in [Chapter 17](#) for details.
- On a Mac computer, make sure the infrared communications extensions have been installed in the Extensions folder inside the System folder. Next, open the HotSync Software Setup window, and be sure that HotSync Manager is enabled and that the Local Setup Port is set to Infrared Port. See [“Conducting IR HotSync operations”](#) in [Chapter 17](#) for more information.
- On your handheld, be sure the HotSync application is set to Local, with the option IR to PC/Handheld.
- Be sure the IR port of your handheld is aligned directly opposite to, and within a few inches of, the infrared device of your computer.
- IR HotSync operations do not work after you receive a low battery warning. Check the battery power of your handheld. Recharge the internal battery.

When I press the HotSync button on the cradle/cable, nothing happens on Palm Desktop software, and my handheld times out.

Try each of these in turn:

- Make a copy of your Palm folder. Uninstall, and then reinstall, Palm Desktop software.
- Turn on your handheld and press Home . Tap the HotSync icon , and then tap Local.

When I perform a HotSync operation, my information does not transfer to Palm Desktop software.

Try each of these in turn:

- If you have performed a HotSync operation successfully but you cannot find the data from your handheld on Palm Desktop software, check to see that you have the correct user name selected for viewing data.
- On a Windows computer, click the HotSync Manager and select Custom. Check that all conduits are set to synchronize files.
- On a Mac computer, double-click the HotSync Manager icon . From the HotSync menu, choose Conduit Settings. Select your username from the User pop-up menu, and check that the correct conduit is active.

My handheld displays the message “Waiting for sender” when it’s near my computer’s infrared port.

Try each of these in turn:

- Your computer’s infrared port may be set to search automatically for the presence of other infrared devices. Consult the documentation for your operating system for information about turning off this option.
- In some cases, simply moving your handheld away from the computer’s infrared port solves the problem.

I want to synchronize my computer with more than one handheld.

Try each of these in turn:

- If the computer running Palm Desktop software synchronizes with more than one handheld, each handheld must have a unique name. Assign a username to your handheld the first time you perform a HotSync operation.
- Please be aware that synchronizing more than one handheld with the same user name causes unpredictable results and, potentially, loss of your personal information.

## Beaming problems

### Problem

I cannot beam data to another device with an IR port.

### Solution

**NOTE** The IR communications feature is not compatible with the Palm VIIx handheld.

Try each of these in turn:

- If you are beaming to another Palm handheld, confirm that your handheld and the other handheld are between ten centimeters (approximately 4") and one meter (approximately 39") apart and that the path between the two handhelds is clear of obstacles. Beaming distance to other devices with an IR port may be different.
- Move your handheld closer to the receiving device.
- Make sure the receiving device has enabled beam receive.

When someone beams data to my handheld, I get a message telling me it is out of memory.

Try each of these in turn:

- Your handheld requires at least twice the amount of memory available as the data you are receiving. For example, if you are receiving a 30KB application, you must have at least 60KB free.
- Perform a soft reset. See [“Performing a soft reset”](#) in [Appendix A](#) for more information.

## Recharging problems

### Problem

When I place my handheld in the cradle, the indicator light does not go on.

### Solution

Try each of these in turn:

- Confirm that your handheld is firmly connected to the cradle/cable.
- Confirm that your recharger cable is properly connected to the cradle/cable. On some cradles/cables the recharger cable connects to the back of the USB or serial port connector that plugs into your computer, and on other cradles/cables the recharger cable connects to the back of the cradle/cable.
- Confirm that your recharger is plugged into an AC outlet that has power.
- With your handheld seated in the cradle/cable. Press the power button and press Home . Confirm that there is a lightning bolt on the battery icon at the top of the screen.
- Charge your handheld for *at least* two full hours.

## Security problems

### Problem

I forgot the password, and my handheld is not locked.

### Solution

- First, use the password hint to try to remember the password. If this does not help, or if you do not have a password hint, you can use Security to delete the password, but your handheld deletes all entries marked as private. However, if you perform a HotSync operation *before* you delete the password, the HotSync process backs up all entries, whether or not they are marked private. Then you can follow these steps to restore your private entries:
  - a. Use the Palm Desktop software and the cradle or infrared communication to synchronize your data.
  - b. Tap Forgotten Password in Security to remove the password and delete all private records.
  - c. Perform a HotSync operation to synchronize your data and restore the private records by transferring them from your computer to your handheld.

I forgot the password and my handheld is locked.

First, use the password hint to try to remember the password. If this does not help, or if you do not have a password hint, you must perform a hard reset to continue using your handheld. See [“Performing a hard reset”](#) in [Appendix A](#) for more information.

## Wi-Fi and VPN problems

### Problem

I am traveling in a foreign country and I can't make a wireless connection.

### Solution

Tungsten C handhelds operate in the Industry Scientific and Medical band (ISM). Not all countries support all channels in the ISM band. Because the regulations for wireless communication vary between countries, the Tungsten C handheld is only certified for use in the country where it was originally sold. For more information on which channels your handheld supports, see [Appendix C](#).



I can't make a wireless connection.

- Your handheld is designed to connect to a wireless access point. Consult your wireless access point manual and the manufacturer website for troubleshooting information regarding your wireless access point.
- Most corporate networks have security policies that require special setup procedures. Contact your IT administrator for information.

The VPN client included with my handheld does not work with my corporate network.

The Palm VPN client is based on the PPTP protocol. Third party software solutions are available if your corporation requires an IPSec client. See [www.palm.com/support/tungstenc](http://www.palm.com/support/tungstenc) for links and information to other VPN solutions.

## E-mail problems

### Problem

I am having problems accessing my account.

### Solution

Occasionally you may experience problems using an e-mail account after you set it up. Be sure to follow the account setup procedures. See [“Setting up and managing e-mail accounts”](#) in [Chapter 14](#). If you followed the procedure and are experiencing problems using the account, verify that the account complies with your e-mail provider’s requirements by following these steps:

- Verify both your password and your username for your e-mail account.
- Verify that your network settings and/or your Wi-Fi or broadband wireless account information is accurate.
- If you are connecting using an external modem device such as a PalmModem® accessory, verify that you have an account with an ISP and are able to dial in over a voice phone line.
- If you are connecting using a mobile phone through either a cable or the IR port on your handheld, verify that you have either a data-enabled GSM or a high-speed GPRS account with your wireless service provider.
- Some wireless service providers require you to be on their network to use your e-mail account. If this is the case, be sure to use your provider's network as the connection type for the account.
- Some wireless service providers have other requirements specific to their service. For example, Yahoo! requires you to set up POP mail forwarding for your Yahoo! account in order to download e-mail messages to your handheld. Check with your service provider to see if any provider-specific requirements exist.
- Service provider settings frequently change. If your e-mail account was working, but you are currently experiencing problems, check with your service provider to see if any of the account settings have changed.

I am having difficulty sending and receiving e-mail using a synchronize-only account.

Make sure you have chosen the same settings for the account on both your handheld and your desktop. For example, if the account is set up on the handheld to use the POP protocol, check the HotSync manager on the desktop to make sure that POP is selected as the protocol for that account.

## Technical support

If, after reviewing the sources listed at the beginning of this appendix, you cannot solve your problem, go to [www.palm.com/support/tungstenc](http://www.palm.com/support/tungstenc) or send an e-mail to your regional Technical Support office.

Before requesting support, experiment a bit to reproduce and isolate the problem. When you do contact support, please be ready to provide the following information:

- The name and version of the operating system you are using
- The actual error message or state you are experiencing
- The steps you take to reproduce the problem
- The version of handheld software you are using and available memory
- The wireless service provider's name
- The software version of your 802.11b radio

**To find your handheld version and memory information:**



1. Press Home .
2. Press Command Stroke  + L.

Alternately, press Function  + Menu , and then select Info on the App Menu.

**NOTE** Thousands of third-party add-on applications have been written for Palm OS handhelds. Unfortunately, we are not able to support such a large number of third-party applications. *If you are having a problem with a third-party application, please contact the developer or publisher of that software.*

3. Tap Version to see version numbers, and tap Size to see the amount of free memory in kilobytes.

**To find your wireless service provider's name and 802.11b radio software version:**

1. Press Home .
2. Tap the Prefs icon .
3. Tap the pick list in the upper-right corner of the screen.
4. Select Mobile.
5. Select Current status.
6. Scroll down to SV number to view the software version of your 802.11b radio.



# Wi-Fi Frequencies

Palm™ Tungsten™ C handhelds operate in the Industry Scientific and Medical band (ISM). The ISM band is an internationally recognized band for radio LANs which operates in the 2.4 Ghz range. There are 14 allocated channels within this band.

Not all countries support all channels in the ISM band. Because the regulations for wireless communication vary between countries, the Tungsten C handheld is only certified for use in the country where it was originally sold. Therefore, if you take your Tungsten C handheld to countries other than where your handheld is certified, there is a possibility that you will not be able to connect to an access point.

The following list identifies by country of purchase which channels your Tungsten C handheld is set for:

Channel ID	Frequency (MHz)	USA FCC	Canada IC	Europe/ Asia Pacific ETSI	France	Japan MKK
1	2412	+	+	+		+
2	2417	+	+	+		+
3	2422	+	+	+		+
4	2427	+	+	+		+
5	2432	+	+	+		+
6	2437	+	+	+		+
7	2442	+	+	+		+
8	2447	+	+	+		+
9	2452	+	+	+		+
10	2457	+	+	+	+	+
11	2462	+	+	+	+	+
12	2467			+	+	+
13	2472			+	+	+
14	2484					+



# Product Regulatory and Safety Information

## FCC Statement

This device complies with part 15 of the FCC rules. Operation is subject to the following two conditions: (1) This device may not cause harmful interference, and (2) this device must accept any interference received, including interference that may cause undesired operation.

**NOTE** This equipment has been tested and found to comply with the limits for a Class B digital device, pursuant to Part 15 of the FCC rules. These limits are designed to provide reasonable protection against harmful interference in a residential installation. This equipment generates, uses, and can radiate radio frequency energy and, if not installed and used in accordance with the instructions, may cause harmful interference to radio communications. However, there is no guarantee that interference will not occur in a particular installation. If this equipment does cause harmful interference to radio or television reception, which can be determined by turning the equipment off and on, the user is encouraged to try to correct the interference by one or more of the following measures:

- Reorient or relocate the receiving antenna.
- Increase the separation between the equipment and receiver.
- Connect the equipment into an outlet on a circuit different from that to which the receiver is connected.
- Consult the dealer or an experienced radio/TV technician for help.

The use of shielded I/O cables is required when connecting this equipment to any and all optional peripheral or host devices. Failure to do so may violate FCC rules.

**CAUTION** Changes or modifications not covered in this manual must be approved in writing by the manufacturer's Regulatory Engineering Department. Changes or modifications made without written approval may void the user's authority to operate this equipment.

In August 1996, the Federal Communications Commission (FCC) of the United States with its action in Report and Order FCC 96-326 adopted an updated safety standard for human exposure to radio frequency electromagnetic energy emitted by FCC regulated transmitters. Those guidelines are consistent with the safety standard previously set by both U.S. and international standards bodies. The design of this product complies with the FCC guidelines and these international standards.

### Exposure To Radio Frequency Energy (SAR)

In order to comply with FCC RF exposure safety guidelines, users **MUST** use a Palm brand body-worn accessory during body-worn operation. Use of accessories not provided by Palm or that have not been tested for RF exposure compliance with this product may not comply with the FCC RF exposure safety guidelines and should not be used.

## FCC Statement

To comply with FCC RF exposure compliance requirements, this device and its antenna must not be co-located or operating in conjunction with any other antenna or transmitter. The user of this device should ensure that the operation of this device is in compliance with these provisions.

**Responsible Party:**

Palm Solutions Group  
400 N. McCarthy Blvd.  
Milpitas, California 95035  
United States of America  
(408) 503-7500

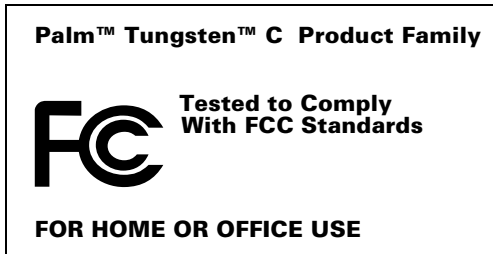

## Industry Canada

The term "IC:" before the certification/registration number only signifies that the Industry Canada technical specifications were met.

## Canadian Wireless Regulatory Notice

This Class B digital apparatus meets all requirements of the Canadian-Interference-Causing Equipment Regulations. Operation is subject to the following two conditions: (1) this device may not cause any interference, and (2) this device must accept any interference, including interference that may cause undesired operation of the device. To prevent radio interference to the licensed service, this device is intended to be operated indoors, and away from windows to provide maximum shielding. Equipment (or its transmit antenna) that is installed outdoors is subject to licensing.

## Battery Warning

Do not mutilate, puncture, or dispose of batteries in fire. The batteries can burst or explode, releasing hazardous chemicals.

**Varning**

Eksplotionsfara vid felaktigt batteribyte. Använd samma batterityp eller en ekvivalent typ som rekommenderas av apparattillverkaren. Kassera använt batteri enligt fabrikantens instruktion.

**Advarsel!**

Lithiumbatteri—Eksplotionsfare ved fejlagtig håndtering. Udskiftning må kun ske med batteri af samme fabrikat og type. Levér det brugte batteri tilbage tilleverandøren.

**Varoitus**

Paristo voi räjähtää, jos se on virheellisesti asennettu. Vaihda paristo ainoastaan valmistajan suosittelemaan tyyppiin. Hävitä käytetty paristo valmistajan ohjeiden mukaisesti.

**Advarsel**

Ekspløsjonsfare ved feilaktig skifte av batteri. Benytt samme batteritype eller en tilsvarende type anbefait av apparatfabrikanten. Brukte batterier kasseres i henhold til fabrikantens instruksjoner.



**Waarschuwing!**

Bij dit produkt zijn batterijen geleverd. Wanneer deze leeg zijn, moet u ze niet weggooien maar inleveren als KCA.

**Uwaga**

Nie kroić lub przekłuwać baterii, ani nie wrzucać ich do ognia. Mogą się rozerwać lub wybuchnąć wydzielając trujące środki chemiczne. Zużytych baterii należy pozbywać się w sposób opisany przez producenta i zgodnie z miejscowymi przepisami.

**אזהרה**

יש סכנת התפוצצות אם מחליפים את הסוללה בצורה לא נכונה.  
יש להחליף את הסוללה בסוללה זהה או דומה, בהתאם להמלצת היצרן.  
יש להשליך סוללות משומשות בהתאם להוראות היצרן

## Intrinsic Safety Warning

**Warning - Explosion Hazard**

Substitution of component may impair suitability for Class I, division 2.

**Warning - Explosion Hazard**

When in hazardous location, turn off power before replacing or wiring modules.

**Warning - Explosion Hazard**

Do not disconnect equipment unless power has been switched off or the area is known to be non-hazardous.

## Wireless Notices - Usage Cautions

In some situations, the use of the wireless device may be restricted. Such restrictions may apply abroad on airplanes, in hospitals, near explosive environments, in hazardous locations, etc. If you are not certain of the policy that applies to the use of this device, please ask for authorization first prior to turning on the device.

## Declaration of Conformity

### European Union Notice

#### CE Declaration of Conformity

Application of Council Directive(s):

89/336/EEC (EMC directive), 99/5/EC (R&TTE directive), 73/23/EEC (Low Voltage Directive)

Standards to which Conformity is Declared:

EN55022	Digital Device Emissions (Class B)
EN301-489-1/-17	Radio Device EMC
EN300-328	Radio Equipment Emissions
EN55024	Digital Device EMC
EN60950	Product Safety
EN50360/50361	SAR Safety

Manufacturers Name: Palm Solutions Group

Manufacturers Location: 400 North McCarthy Blvd.  
Milpitas, CA 95035-5112  
USA

Importers Name: Palm Germany GmbH

Importers Location: Landsberger Strasse 155  
D-80687 Munchen  
Germany

Type of Equipment: Handheld Computer

Model Number: Tungsten C

Year of Manufacture: 2002

I, the undersigned hereby declare that the equipment specified above conforms to the above Directive(s) and Standard(s)

Place: Santa Clara, CA David Woo

Date: 10-28-02 Global Compliance Manager

#### English

Hereby, Palm Solutions Group, declares that this 802.11B PDA is in compliance with the essential requirements and other relevant provisions of Directive 1999/5/EC.

#### Finnish

Palm Solutions Group vakuuttaa täten että 802.11B PDA tyyppinen laite on direktiivin 1999/5/EYoleellisten vaatimusten ja sitä koskevien direktiivin muiden ehtojen mukainen.

#### Dutch

Hierbij verklaart Palm Solutions Group dat het toestel 802.11B PDA in overeenstemming is met de essentiële eisen en de andere relevante bepalingen van richtlijn 1999/5/EG.

Bij deze verklaart Palm Solutions Group dat deze 802.11B PDA voldoet aan de essentiële eisen en aan de overige relevante bepalingen van Richtlijn 1999/5/EC.

**French**

Par la présente Palm Solutions Group déclare que l'appareil 802.11B PDA est conforme aux exigences essentielles et aux autres dispositions pertinentes de la directive 1999/5/CE.

Par la présente, Palm Solutions Group déclare que ce 802.11B PDA est conforme aux exigences essentielles et aux autres dispositions de la directive 1999/5/CE qui lui sont applicables.

**Swedish**

Härmed intygar Palm Solutions Group att denna 802.11B PDA står i överensstämmelse med de väsentliga egenskapskrav och övriga relevantabestämmelser som framgår av direktiv 1999/5/EG.

**Danish**

Undertegnede Palm Solutions Group erklærer herved, at følgende udstyr 802.11B PDA overholder de væsentlige krav og øvrige relevante krav i direktiv 1999/5/EF.

**German**

Hiermit erklärt Palm Solutions Group, dass sich dieser/diese/dieses 802.11B PDA in Übereinstimmung mit den grundlegenden Anforderungen und den anderen relevanten Vorschriften der Richtlinie 1999/5/EG befindet". (BMWi)

Hiermit erklärt Palm Solutions Group die Übereinstimmung des Gerätes 802.11B PDA mit den grundlegenden Anforderungen und den anderenrelevanten Festlegungen der Richtlinie 1999/5/EG. (Wien)

**Greek**

Με το παρόν, ο όμιλος εταιρειών Palm Solutions δηλώνει υπεύθυνα ότι αυτή η συσκευή Προσωπικού Ψηφιακού Βοηθού (PDA) κατά 802.11B συμμορφούται με τις ουσιώδεις απαιτήσεις και άλλες σχετικές διατάξεις της Οδηγίας 1999/5/ΕΚ.

**Italian**

Con la presente Palm Solutions Group dichiara che questo 802.11B PDA è conforme ai requisiti essenziali ed alle altre disposizioni pertinenti stabilite dalla direttiva 1999/5/CE.

**Spanish**

Por medio de la presente Palm Solutions Group declara que el 802.11B PDA cumple con los requisitos esenciales y cualesquiera otras disposiciones aplicables o exigibles de la Directiva 1999/5/CE.

**Portuguese**

Palm Solutions Group declara que este 802.11B PDA está conforme com os requisitos essenciais e outras disposições da Directiva 1999/5/CE.



## Numerics

- 802.11b
  - adding WEP encryption 362
  - connection information 355
  - network settings 355
  - signal field 355
  - turning radio on and off 355

## A

- ABA (Address Book archive file) 34
- Accented characters, Graffiti 2 writing 29
- Access point 358
- Account. *See* E-mail account
- Action icons 274
- Add-on applications 63–70
- Address Book
  - \*If Found Call\* entry 75
  - adding custom fields 81
  - adding e-mail address from 197
  - adding entry from e-mail 224–225
  - archive files (.aba) 34
  - business card for beaming 32
  - categorizing records 51
  - conduit for synchronizing 306
  - creating records 47
  - deleting records 49
  - displaying category 81
  - displaying data in the Address list 76
  - finding records 14, 54
  - fonts 61
  - Look Up 54
  - menus 80
  - notes for records 60
  - opening 74
  - overview 73
  - private records 377
  - sorting records 59
  - using to address e-mail 197

- Addressing e-mail
  - displaying another address 153, 160, 167, 255
  - message 196–199
  - using Smart Addressing 198
- Ad-hoc connection 359
- Advanced preferences 221
- Agenda (Date Book view) 101
- Alarm
  - LED setting 335
  - lists 62
  - preset 105
  - setting in Clock 301
  - setting in Date Book 95
  - setting in Note Pad 122
  - sound 105, 180, 302, 334, 394
  - vibrate setting 335
- Alerting for new mail 179
- Alphabet
  - Graffiti 2 writing 26
- APOP
  - adding to an account 254, 257, 259
  - and synchronization 229
  - requirement 147, 253
- Application buttons 9, 37, 74, 91, 365
- Applications
  - Address Book 73
  - beaming 32–33
  - Calculator 83
  - Card Info 87
  - categories 39–40
  - copying text to other 285
  - Date Book 91
  - downloading 278
  - Expense 107
  - font style 61
  - installing 63–69
  - Launcher 37–41
  - Memo Pad 115
  - Note Pad 119
  - opening 37

- Palm Photos 125
  - Palm VersaMail 143
  - plug-in 349
  - PRC (application file extension) 349
  - preferences for 46
  - removing 69
  - To Do List 137
  - viewing as icons 40
  - viewing as list 40
  - Web Browser 273
  - World Clock 295
  - See also* Add-on applications
- Archive files
- importing data from 34
  - for main applications 34
  - saving deleted records 49
  - saving purged records 50
- Attaching a signature to messages 154, 161, 168
- Attachments
- attaching files from an expansion card 215
  - attaching files from applications 213
  - downloading 224
  - icon for 183
  - saving to expansion card 212
  - selecting plug-ins 241
  - sending 199
  - using Documents To Go 240–242
- Auto get mail 175
- notification options 179
  - notifications 178
  - Reminders screen 181
  - resource issues 183
  - scheduling 176
  - VPN connections 148
- AutoCorrect 15
- Autofill, in Web Browser 291
- Automatic fill, in Expense 114
- Automatic sending of messages. *See* Send retry
- Auto-off delay 332
- Autotext. *See* Graffiti 2 ShortCuts
- B**
- Background sending of messages. *See* Send retry
- Backing up e-mail databases 265
- Backlight, adjusting 12
- Battery
- auto-off delay 332
  - charging 386
  - conserve power 356
  - conserving power 332
  - doesn't charge 393
  - gauge 37
  - life and use 386
  - recycling 386
  - warning 412–414
- Bcc field 196
- See also* Blind copies
- Beaming
- location of IR port 8
  - problems with 402
  - See also* Infrared
- Beep for new mail 178
- Blind copies 153, 154, 160, 161, 167, 168, 197, 255
- Blinking asterisk 181
- Bold font for text 61
- Bookmarks
- adding 281
  - deleting 282
  - editing 282
  - visiting pages 281
- Brightness
- adjusting 12
  - key location 16
- Broken envelope icon 181
- Browsing the web 276–280
- Business card for beaming 32
- Buttons preferences 365–366
- HotSync 366
  - mapping 365
- C**
- Calculator
- buttons explained 83–84
  - memory 84
  - overview 83
  - recent calculations 83, 84
- Calibration 13, 328
- Call waiting
- disabling 342
- Calling card, using in phone settings 343

- Capital letters
  - CAPS key location 16
  - Graffiti 2 writing 27
- CAPS key
  - function 17
  - location 16
- Card Info 87
- Caring for the handheld 385
- Categories
  - application 39–40
  - assigning records to 50–51
  - beaming 32–33
  - creating 52–53
  - default 39, 51
  - displaying 52, 81, 396
  - merging 54
  - renaming 53
  - using in Applications Launcher 40
- Category
  - for bookmarks 281, 282
  - for saved pages 284
- Cc field 197
- Chain calculations 84
- Characters, Graffiti 2 22
- Charging battery 386
- Check boxes 20
- Clearing
  - Calculator entries 83
  - History list 289
  - reminders 181
- Color Theme Preferences 366
- Combining categories 54
- Comma delimited files, importing data
  - from 34
- Command
  - bar in VersaMail 262
  - buttons 21
  - stroke key 45, 46
  - toolbar 46
- Command stroke key 46
- Communication preferences 325
  - Network 339–350
  - Serial 337–339
  - VPN 354
  - Wi-Fi 355–361
- Compressing Day view 104
- Compression 273
- Conduits
  - account information screens 236
  - for synchronizing applications 397
  - shortcuts 238
  - SSL and 244
  - for synchronizing applications 306–307, 388, 389
  - for synchronizing applications, Mac 307
  - synchronizing multiple accounts 244
- Conflicting events 102
- Connecting
  - IR to PC 338
  - selecting for network 341
  - service templates 344
  - to server or ISP 344
- Connection types
  - changing in account 250
  - GPRS, prerequisite for 146
  - GSM, prerequisite for 146
  - modem sled, prerequisite for 146
  - network connection 145
  - PalmModem accessory, prerequisite for 146
  - synchronize-only connection 145
- Content
  - latest 280
  - old 280
- Continuous events
  - deleting from Date Book 49
  - scheduling 97
- Contrast control 12
- Contrast. *See* Brightness
- Cookies 292
- Copying
  - notes into other applications 119
  - photos into other applications 125
  - text 48
  - text in Web Browser 285
- Cradle
  - connecting to computer 10
  - for local HotSync operations 313, 319
  - settings 333
  - viewing data from 333
- Creating
  - Address Book entries 74–75
  - categories 39–40, 52–53
  - currency symbols 111
  - custom fields in Address Book 81

- Date Book events 91
- Expense items 108
- expense reports 113
- HotSync user profile 321
- list items 138
- note 120
- notes for records 60
- photo album 130
- records 47
- security shortcuts 383
- ShortCuts 383
- Currency
  - default 111
  - defining 111
  - for Expense items 110
- Current
  - date 395
  - time 37
- Custom
  - currencies and symbols 111
  - fields in Address Book 81
- Customizing Web Browser 286–291
- Cutting text 48
- Cycling through views 74, 91
  
- D**
- Data entry. *See* Entering data
- Database
  - backing up 265
  - upgrading a MultiMail database 144
- Date
  - displaying in Clock 302
  - Expense item 109
  - setting 327
  - setting current 296, 395
  - setting preference 327
  - To Do List record due 140–141
- Date and Time preferences 327–328
- Date Book
  - adding Address Book data to records 56
  - Agenda view 101
  - alarm 95
  - archive files (.dba) 34
  - changing event time 95
  - changing event to untimed 95
  - conduit for synchronizing 306
  - conflicting events 102
  - continuous events 97–98
  - creating records 47, 92–95
  - Day view 99
  - deleting records 49
  - display options 104
  - end time for Day view 105
  - fonts 61
  - menus 103
  - Month view 100
  - notes for records 60
  - opening 91, 276
  - overview 91
  - private records 377
  - purging records 50
  - repeating events 49, 97–98
  - scheduling events 91–93, 278–280
  - selecting dates 93
  - start time for Day view 105
  - Sunday or Monday to start week 329
  - switching views 99
  - untimed events 92, 94
  - viewing appointment reminders 181
  - Week view 99, 329, 396
- Day
  - Date Book view 92, 104
  - displaying in World Clock 302
- Daylight savings 327
- DBA (Date Book archive file) 34
- Decimal point 329
- Default 274
  - categories 39, 51
  - currency in Expense 111
  - setting
    - for autofill 291
    - for cookies 292
- Delete key 16
- Deleted data, saving in archive files 49
- Deleting
  - applications 69
  - bookmarks 282
  - Desktop software 70
  - e-mail 217–219, 255
  - filters 249
  - Graffiti 2 characters 25
  - mail in the trash 220
  - old messages 218
  - passwords 369
  - records 49
  - saved pages 285
  - service templates 350



- text 48
  - See also* Purging records
- Desktop software
  - displaying euro 113
  - linking to external files 35, 320
  - removing 70, 71
  - saving deleted data to an archive file 49
- Dial-Up network
  - idle timeout 345
  - login scripts 347–349
  - password 340
  - phone settings 341
  - primary DNS 346
  - secondary DNS 346
  - selecting connection 341
  - selecting service 339
  - username 340
- Digitizer 13
  - calibration 13
  - preferences 328
- Disabling
  - autofill 291
  - cookies 291
- Disconnecting a modem 261
- DNS (Domain Naming System)
  - changing 358
  - defining 346
  - view address 355
- Documents To Go
  - converting attachments 240–242
- Double-booked events 102
- Download
  - attachments 183
  - files, all types 278
  - message size 152, 160, 166
  - stopping 279
- Drafts
  - creating 194
  - saving 199, 202
- Dragging
  - memos into other applications 115
  - using the stylus 14
- E**
- Editing
  - bookmarks 282
  - records 47
  - saved pages 284
- E-mail 274
  - adding Address Book entry from e-mail ??–225
  - adding Address Book entry from email 224–??
  - adding attachments 213–214
  - addresses in Address Book 75
  - addressing 196
  - alert for new mail 179
  - attaching files 174
  - attaching files from an expansion card 215
  - attaching files from applications 213
  - attachments 207–217
  - auto get notifications 178
  - backing up databases 265
  - beeping for new mail 178
  - buzzing or blinking for new mail 180
  - color selection 186
  - composing 199
  - copying and pasting text 261
  - creating new messages 195–199
  - days to synchronize 231
  - deleting messages on handheld 217–219
  - deleting messages on server 255
  - display options 186
  - downloading large attachments 210–212
  - drafts 202
  - emptying trash 220–221
  - filters for 245–246
  - folder on server 255
  - font selection 186
  - forwarding 203, 205
  - forwarding attachments 217
  - getting entire message 174
  - getting on desktop 227–230
  - getting subject only 174
  - header details 263
  - HTML 185
  - icons 183, 202
  - leaving mail on server 152, 159, 165, 253
  - managing mail settings 249
  - marking read and unread 221–223
  - maximum message size 152, 160, 166
  - message format 185
  - notification options 179
  - personal signature 203, 224
  - preferences 223–224
  - reading 173

- relying to 205–206
  - saving attachments to expansion
    - card 212
  - scheduling auto get mail 176
  - Secure Sockets Layer
  - send retry 201
  - sending 199
  - signature, adding 154, 161, 168
  - storing in Outbox 199
  - trash 220
  - URLs in messages 207
  - viewing attachments 207–210
- E-mail account
- advanced preferences 260
  - APOP setting 254
  - auto get mail 175
  - before setting up 146
  - changing e-mail address 252
  - changing mail server settings 253
  - changing protocol type 250
  - changing username and password 250
  - checking for new messages 173, 174
  - color selection 186
  - corporate 147
  - creating a synchronize-only
    - account 155–162
  - creating new 149–153, 159–160
  - default mail service 170–172, 251
  - deleting accounts 169–170
  - display options 186
  - displaying Inbox 173
  - editing 168, 169
  - editing accounts 163–257
  - font selection 186
  - incoming and outgoing server 150, 157, 164
  - managing mail settings 249
  - notification option 178
  - outgoing mail server 255
  - password 150, 157, 164
  - problems with 172
  - synchronization options 227–230
  - synchronizing 226, 242–243
  - troubleshooting 172
  - username 150, 157, 164
  - wireless coverage indicator 268
- Enabling
- autofill 291
  - cookies 291
- Encryption
- handheld data 381
  - Web Browser 274
  - WEP 362
- Entering data
- importing from other applications 34–36
  - problems with 395
  - using the computer keyboard 34
- Entries. *See* Address Book
- Envelope icon 183
- Error log 226
- ESMTP 147, 257
- adding to an account 259
- Eudora, configuring for e-mail 240
- Euro
- displaying on desktop computer 113
  - in Expense 110, 111
  - in Graffiti 2 writing 30
  - in onscreen keyboard 18
  - printing 113
- Events. *See* Date Book
- Exclamation marks in To Do List 141
- Expansion Card
- adding hardware 10
  - applications 38
  - copying applications 41
  - described 11
  - formatting 88
  - renaming 88
  - using cards 87
- Expense
- adding Address Book data to
    - records 57–58
  - categorizing records 51
  - creating records 108
  - currency 110
  - date of item 109
  - defining new currency 111
  - menus 113
  - overview 107
  - receipt details 109
  - reports 113
  - type 109, 114
  - vendor 110
- Extended MAPI 228
- F**
- FCC Statement 411

- Files
    - converting attachments 240–242
    - error log 226
    - linking to external 35, 320
  - Filters
    - creating 245–247
    - deleting 249
    - editing 249
    - examples of 248
    - turning on and off 248
  - Find key 16
  - Finding
    - Find key location 16
    - information in applications 54–58
    - phone numbers 56
    - using the Find application 56
    - visited pages 286
    - Web Browser version 293
  - Folders
    - creating new 194
    - viewing other 186
  - Fonts 61, 113
  - Formats preferences 328
  - Forwarding e-mail 203
  - Frequently asked questions (FAQs)
    - application problems 395
    - beaming problems 402
    - e-mail problems 406
    - HotSync problems 397
    - operating problems 393
    - recharging problems 403
    - security problems 404
    - software installation problems 392
    - tapping and writing problems 395
    - VPN problems 404
    - Wi-Fi problems 404
  - Frozen handheld 394
  - Function key
    - location 16
    - locking 19
    - using 18
- G**
- Games 335
  - General preferences 180, 326–336
    - alarm LED setting 335
    - alarm sounds 334
    - alarm vibrate setting 335
    - Date and Time 327–328
    - Digitizer 328
    - Formats 328
    - Keyboard 330, 332
    - Power 332–334
    - system sounds 334
    - Writing Area 335
  - Getting e-mail
    - checking for new messages 174
  - Glossary. *See* Graffiti 2 ShortCuts
  - GPRS
    - prerequisite for connection 146
  - Graffiti 2
    - accented characters 29
    - alphabet 22, 26
    - basic concepts 23
    - capital letters 27
    - how to write characters 24
    - numbers 27
    - Preferences 330
    - problems using 395
    - punctuation marks 28
    - ShortCuts for entering data 31
    - symbols 30
    - tips 25
    - writing area 24
    - Writing Area preferences 335
  - GSM
    - prerequisite for connection 146
- H**
- Handheld
    - alarm 180
    - blinking 180
    - buzzing 180
    - increasing space on 11
    - vibrating 180
  - Hard reset 387, 393
  - Hardware add-ons 10
  - Help
    - online tips 22
    - Web Browser 275
  - Hiding records 376
  - Home page
    - changing 287
    - returning to 278

## HotSync

- buttons preferences 366
- conduits for synchronizing
  - applications 306–307, 388, 389
- conduits for synchronizing applications, Mac 307
- customizing 306, 307
- first-time operation 312–316, 321–323
- IR operation 317–320
- linking to external files 35, 320
- local operation 304, 313, 398, 399
- local operation on Mac 315
- modem operation 304
- network HotSync problems 397
- network operation 308–312
- operations using cradle 319, 337
- operations using IR port 317–319, 338–339
- problems launching application 398
- problems with 397–401
- problems with IR 400
- restoring data 388–389
- setting options 303–305
- starting Manager 226
- synchronize active accounts 226
- synchronizing e-mail 243
- using with another PIM 70

Hyperlink. *See* link

**I**

## Icon

- alarm 95
- application 40
- Back 277
- broken envelope 181
- for e-mail messages 183, 202
- Forward 278
- function lock
  - Icon
    - function active 19
- Home 278, 287
- HotSync Manager 226
- lock 33
- note 60
- online tips 22
- Open URL 276
- paperclip 183
- Quick Connect 77

## Quick Tour 5

- Refresh 279
- repeating event 97
- Stop 279
- Tips 22, 275
- VersaMail e-mail 183
- Web Content 281

Idle timeout of ISP or server connection 345

## Images

- behavior in Web Browser 273
- changing download preferences 288
- copying 285

## IMAP

- adding an account 149, 156, 163
- ESMTP synchronization in 230
- root mailbox 254
- server options 152, 159, 165
- synchronize an account 230
- wireless folder synchronization 265

Importing data 34–36

## Inbox

- Reminders screen and 181
- synchronizing 232
- viewing mail 173

Incoming mail server 150, 157, 164

- changing 253

## Indicator light

- problems 394
- setting 335

Industry Scientific and Medical band

(ISM) 3, 355, 404, 409

## Infrared

- connections 337
- HotSync operations 317–319, 338–339
- PC connection 338
- port 8, 317
- problems with IR HotSync
  - operations 400
- requirements for computer 317

## Installing

- applications 63–69
- conduit to install applications 306

International characters

- Graffiti 2 writing 29
- keyboard 17
- typing 17

## Internet

- password 340
- selecting connection 341

username 340  
 Web Browser access 290  
 IP address  
   changing 358  
   dynamic 346  
   service template 344  
   view address 355  
 IR port.  
   *See also* Beaming and Infrared  
 IrCOMM 317, 337  
 IrDA (Infrared Data Association) 317  
 ISM (Industry Scientific and Medical band) 409  
 ISP  
   login script 147  
   requirements for 146  
   requiring APOP 254, 257, 259  
   requiring ESMTP 259  
 Items. *See* To Do List or Expense  
  
**J**  
 Jumping to another web page 277  
  
**K**  
 Keyboard  
   computer 34  
   description 15  
   key clicking 331  
   key repeat rate 330  
   keyboard type 16  
   preferences 330, 332  
   press-and-hold 331  
   remapping keys 331  
   shortcuts in VersaMail 271  
  
**L**  
 LED alarm 335  
 Letters  
   font style 61  
   Graffiti 2 22, 26  
 Link 277, 278  
 List, in Applications Launcher 40  
 Location  
   setting primary 296, 297  
   setting secondary 298  
 Locking the handheld with a password 367,  
   371–374

Logging informational errors 226  
 Login script 147, 347–349  
 Looking up Address Book data  
   to add to other records 56  
   scrolling in Address list 54  
 Lost  
   handheld, contact for 75  
   records 396  
 Lotus Notes, selecting as mail client 228  
 Lotus Organizer, importing data from 34

## M

MAC address 355  
 Mac computer, system requirements 4  
 Mail server settings, changing 253  
 Mail service, default service for e-mail  
   account 170–172, 251  
 Mail settings  
   changing e-mail address 252  
   changing mail server settings 253  
   changing protocol type 250  
   changing username and password 250  
   managing 249  
 Mailbox, adding new 149  
 Maintenance information 385  
 Marking messages unread/read 221  
 Maximum message size  
   incoming e-mail 152, 160, 166  
   POP and IMAP server 253  
 Memo Pad  
   adding Address Book data to records 56  
   archive files (.mpa) 35  
   conduit for synchronizing 306  
   creating records 47  
   deleting records 49, 98  
   dragging memos into other  
     applications 115  
   fonts 61  
   menus 85, 117  
   opening 115  
   private records 377  
   reviewing memos 116  
   sorting records 59, 396  
 Memory  
   for beaming 402  
   Calculator 84  
   copying text to 285  
   handling content in 273

- limitations on History list 277, 289
- regaining 50, 394
- Memos. *See* Memo Pad
- Menu bar 275, 277
- Menu commands 45
  - accessing 20
  - key location 16
  - using 45
- Menus 43–45, 46
  - Address Book 80
  - choosing 44
  - command equivalents (Graffiti 2 writing) 45
  - command toolbar 45
  - commands 45
  - Date Book 103, 302
  - Dial-Up preferences 350
  - Edit menu 48
  - Expense 113
  - key location 16
  - Memo Pad 85, 117, 123
  - menu bar 20, 44
  - menu commands 20
  - Palm Photos 136
  - problems 395
  - To Do List 142
  - Web Browser 293
- Microsoft Exchange 5.0 228
- Microsoft Outlook
  - connecting to 398
  - synchronizing with 228
- Microsoft Outlook Express
  - configuring for e-mail 239
  - selecting as mail client 228
- Modem
  - auto-disconnect 261
  - timeout 261
- Modem sled, prerequisite for connection 146
- Modifying
  - home page 287
  - image download preferences 288
- Monday, to start week 329
- Month (Date Book view) 100, 104
- MPA (Memo Pad archive file) 35
- MultiMediaCard 7
  - See also* Expansion Card
- Multiple addressees 197

**N**

- Navigator 14
  - description 9
  - in VersaMail 269
  - location 8, 9
  - look up Address Book record 55
  - scroll 21
  - scroll in Address Book 75
- Netscape 228
- Network
  - 802.11b 355
  - access point 358
  - HotSync 310
  - network HotSync problems 397
  - preferences 339–350
  - VPN preferences 350
  - VPN problems 404
  - Wi-Fi preferences 355
  - Wi-Fi problems 404
- Network connection 145
  - connecting to service 344
  - connection methods 145
  - GPRS, prerequisite for 146
  - GSM, prerequisite for 146
  - HotSync operation 308–312
  - modem sled, prerequisite for 146
  - PalmModem accessory, prerequisite for 146
- Note Pad
  - alarm 122
  - copying notes into other applications 119
  - menus 123
  - opening 119
  - overview 119
  - reviewing notes 120
- Notes, attaching to records 60
- Notifications. *See* Auto get mail
- Numbers
  - decimal point and thousands separator 329
  - Graffiti 2 writing 27

**O**

- Old content 280, 291
- Old messages, deleting 217
- Onscreen keyboard 48

- Opening
    - Address Book 74
    - applications 37
    - bookmarked pages 281
    - Calculator 83
    - Card Info 87
    - Clock 295
    - Date Book 91, 276
    - Expense 107
    - Memo Pad 115
    - Note Pad 119
    - Palm Photos 125
    - saved pages 283
    - To Do List 137
    - Web Browser 276
  - Organizer (Lotus PIM) 34
  - Outbox 194
    - storing e-mail 199
    - synchronizing 232
  - Outgoing server, settings 150, 157, 164, 255
  - Outlook, connecting to 398
  - Overlapping events 102
  - Overview of Web Browser 273–275
  - Owner preferences 367
- P**
- Pages. *See* web pages
  - Palm OS
    - database 278
    - upgrade 3
  - Palm Photos
    - albums 132–133
    - beaming photos 134
    - copying photos 131
    - copying photos into other applications 125
    - deleting photos 135
    - desktop software 135
    - List view 126
    - menus 136
    - opening 125
    - organizing photos 129–131
    - photo details 129
    - rotating photos 128
    - slide show 127
    - thumbnail view 126
    - viewing photos 125
  - Palm Quick Install 64–67
  - PalmModem accessory, prerequisite for connection 146
  - Paperclip icon 183
  - Password 150, 157, 164
    - changing 250, 369
    - deleting 369
    - editing in account 163
    - for network 340
    - forgotten 404
  - Pasting
    - notes into other applications 119
    - photos into other applications 125
    - text 48
  - Payment, Expense item 110
  - PDB. *See* Palm OS database
  - Peer-to-peer connection 359
  - Peripheral hardware 10
  - Personal preferences 326, 364
    - Buttons 365–366
    - Color Theme 366
    - Security 368–383
    - ShortCuts 383–384
  - Phone
    - Lookup 56
    - selecting numbers for Address list 76
    - selecting types of numbers 75
    - settings for ISP or dial-in server 341
  - Photos
    - See* Palm Photos
  - Pick lists 21
  - PIM (personal information manager), using HotSync Manager with 70
  - Plug-ins 241, 349
  - POP accounts, APOP synchronization in 229
  - POP3 accounts 152, 159, 165
    - adding an account 149, 156, 163
  - Port number 254, 257
  - Ports
    - IR on handheld 317
    - serial 4
    - USB 4
  - Power button 9
  - Power preferences 332–334
  - PPP 344
  - PPTP protocol 350
  - PRC. *See* Applications
  - Preferences
    - Advanced 221
    - advanced 260

- Buttons 365–366
  - choosing 46
- Color Theme 366
- Communication 325
- Date and Time 327–328
- deleting e-mail 223
- Digitizer 328
- Formats 328
- General 325, 326
- getting mail 223
- Graffiti 2 22
- Keyboard 332
- mail databases 265
- Network 339–350
- Owner 367
- Personal 326
- Power 332–334
- Security 368–383
- Serial 337–339
- ShortCuts 383–384
- Sounds & Alerts 334
- Trash 221
- VPN 354
- Wi-Fi 355–361
- Writing Area 335–336
- Primary DNS 346
- Prioritizing To Do List records 138, 142
- Private records
  - displaying and creating 375–377, 396
  - lost with forgotten password 374
- Profile
  - mobile user 321
  - VersaMail 230
- Protocol
  - changing type 250
  - PPTP 350
- Punctuation marks
  - Graffiti 2 writing 28
- Purging
  - records 50
  - See also* Deleting
- Push e-mail 181

## Q

- Quick Connect 77
- Quick Install 64–67

## R

- Radio
  - connection information 355
  - signal field 355
  - turn on and off 355
  - Wi-Fi settings 355
- Range of times in Day view 105
- Read messages, marking 221
- Reading e-mail 173–184
- Receipts, recording in Expense 109
- Recharging the battery 333
- Records
  - Address Book 54, 80
  - beaming 32–33
  - choosing categories 50
  - creating 47
  - Date Book 92
  - defined 47
  - deleting 49, 98
  - displaying a category of 52
  - editing 47
  - Expense 57, 108
  - fonts 61
  - hiding private 368, 376
  - look up 54
  - lost 396
  - masking private 368
  - Memo Pad 115
  - Note Pad 123
  - notes for 60
  - Phone Lookup 56
  - private 375–377
  - purging 50
  - sorting 58–59
  - To Do List 138
  - unmasking individual 377
- Refreshing a page 279
- Reminder, lists 62
- Reminders screen
  - send retry 201
  - types of reminders 181
  - using 181
  - viewing 181
- Removing
  - applications 69
  - bookmarks 282
  - Desktop software 70
  - saved pages 285



- 
- Renaming
    - bookmarks 282
    - categories 53
    - saved pages 284
  - Repeating events
    - deleting from Date Book 49
    - scheduling 97
  - Replying to e-mail 205
  - Rescheduling events 95
  - Resetting handheld
    - hard reset 387, 393
    - location of reset button 10, 386
    - soft reset 386
  - Restoring data
    - Mac 389
    - Windows 388
  - RSA. *See* encryption
- S**
- Saved pages
    - definition 283
    - deleting 285
    - opening 283
    - renaming 284
    - viewing information about 280
  - Saving
    - data 39, 47, 49
    - e-mail databases 265
    - e-mail messages 218
  - Scheduled retrieval of e-mail. *See* Auto get mail
  - Scheduling events 91–95
  - Screen
    - blank 393
    - calibrating 13, 328
    - caring for 385
    - changing color theme 366
    - touching with your finger 9
  - Scroll bar 21
  - SD card 7
  - SDIO card 7, 10
  - Searching. *See* Finding
  - Secondary DNS 346
  - Secure Sockets Layer
  - Security
    - changing password 369
    - deleting password 369
    - preferences 368–383
    - private records 375–377
    - setting a password hint 369
    - shortcuts 382
    - unmasking individual records 377
    - Web Browser 274
  - Selecting
    - date for event 93
    - phone numbers in Address Book 75
    - text 48
  - Send
    - category 117, 123
    - e-mail 199
    - event 103
    - memo 117
    - notes 123
    - photos 136
    - problems 401
  - Send retry 200
    - modifying messages during 202
    - notifications 201
    - VPN connections 148
  - Sent, item 142
  - Serial
    - troubleshooting 398, 399
  - Serial port 4, 304
  - Serial Preferences 337–339
  - Serial, troubleshooting 398, 399, 400, 403
  - Server
    - deleting messages on 220, 223
    - sent mail folder 255
  - Service
    - selecting for network 339
    - templates 344, 350
  - Settings. *See* Preferences
  - ShortCuts
    - backing up 306
    - for entering data 19, 384
    - key location 16
    - managing 383–384
    - menu commands 45
    - predefined 31
    - preferences 383–384
    - security 382
    - using 19, 31
  - Show penstroke 336
  - Signature 154, 161, 168
    - attaching personal 203, 224
  - SMAPI (Simple MAPI) 228
-

- Smart Addressing
  - turning on 199
  - using 198
- SMTP settings 255
- Soft reset 386
- Sorting
  - applications 40
  - photos 130
  - records 58–59, 396
- Sound
  - alarm on handheld 180
  - problems 394
- Special characters, typing 17
- Speed 274, 279
- Spelling correction, automatic 15
- SSL. *See* Secure Sockets Layer
- Starting applications 37
- Stopping a download 279
- Stylus
  - dragging with 14
  - tapping with 13
- Sunday, to start week 329
- Symbol
  - key 16
  - for currency 110
  - in Graffiti 2 writing 30
- Synchronize-only
  - connection 145
  - creating account 155–162
- Synchronizing
  - an existing username 144
  - IMAP folders 265
- Synchronizing e-mail 242–243
  - account information screens 236
  - active accounts 243
  - e-mail applications for 228
  - HotSync operation 227
  - logging errors 226
  - setting how many days 231
  - shortcuts 238
  - SSL and 244
  - synchronizing multiple accounts 244
  - turn off synchronization 243
- System
  - conduit 306
  - requirements 4
  - sounds 334

## T

- Tab
  - delimited files, importing data from 34
  - key 16
- Tapping 13
- TCP/IP 339
- TDA (To Do List archive file) 35
- Technical support 391, 407
- Text
  - copying 48
  - copying and pasting in e-mail 261
  - cutting 48
  - entry. *See* Entering data
  - files, importing data from 34, 36
  - fonts for 61
  - selecting all 48
- Thousands separator 329
- Time
  - alarm setting 95
  - format 329
  - setting current 297, 328
  - setting event 92
  - setting preference 327
  - start and end for Date Book Day view 105
- Time zone
  - location 299
  - setting 327
- Tips
  - online 22
  - Web Browser 275
- Title bar 274, 279
- To Do List
  - adding Address Book data to records 56
  - archive files (.tda) 35
  - categorizing records 50, 142
  - checking off items 139
  - completed items 141
  - completion date 141
  - conduit for synchronizing 306
  - creating records 47
  - deleting records 49, 98
  - due date 140–141
  - fonts 61
  - menus 142
  - notes for records 60
  - opening 137
  - overview 137

- prioritizing records 138, 142
- private records 377
- purging records 50, 141
- sorting records 59
- viewing reminders 181
- To field 197
- Today. *See* Current date
- Trash
  - automatically emptying 221
  - creating other folders 194
  - emptying deleted e-mail 220–221
  - setting frequency in preferences 221
- Troubleshooting 391, 400, 407
- Turning off handheld
  - automatically 332
  - problems with 394
- Turning on handheld
  - displaying owner's name 367
  - power button 9
  - problems with 393

**U**

- Undoing actions 48
- Uniform Resource Locator. *See* Web address
- Uninstalling Desktop software 70
- Universal connector 10, 337
- Unread mail 152, 159, 165, 253
- Unread messages, marking 221
- Unresponsive handheld 394
- Untimed events 92, 94, 95, 96
- Upgrading
  - a MultiMail database 144
  - Palm OS 3
- URLs
  - in e-mail messages 207
  - See* Web address
- USB
  - cradle/cable 305
  - infrared communication 319
  - Local tab settings 304
  - port 4
  - troubleshooting 398, 403
- User profiles, HotSync operation
  - with 322–323
- Username 150, 157, 164
  - changing 250
  - editing in account 163
  - entering 250

- for ISP 340
- identifying handheld 367
- synchronizing existing 144

**V**

- vCal 34, 36
- vCard 34, 36
- Vendor for Expense item 110
- VersaMail
  - application 143–271
  - icons 183, 202
  - setting preferences for 223
- Vibrate alarm 180, 335
- Video
  - files 63, 67
- Viewing
  - page information 280
- Visiting
  - bookmarked pages 281
  - web pages 276
- Voice jack 10
- VPN
  - access e-mail 148
  - configure your account 351
  - connecting 353
  - description 350
  - disconnecting 354
  - edit account 352
  - PPTP protocol, Server, VPN 350
  - preferences 354

**W**

- Web address
  - changing home page 287
  - changing starting page 287
  - definition 273
  - entering in Web Browser 276
  - See* URLs
- Web Browser
  - ask before connecting 291
  - autofill forms 291
  - bookmark information 282
  - changing home page 287
  - changing size of History list 289
  - clear History list 289
  - Connecting preferences 290

- connection speed, effect on
  - browsing 273
- cookies 292
- definition of History list 277, 286
- displaying old content 291
- General preferences 287
- home page 287
- image download 288
- image download preferences 288
- JavaScript 288
- limitations on size 289
- menus 293
- old content 291
- opening 276
- Privacy preferences 291
- proxy server 291
- returning to a page in History list 286
- returning to a web page 277
- returning to your home page 278
- S in title bar 283
- saved page information 284
- saving pages 283
- search for text 285
- size of History list 289
- version number 293
- Web Preferences 286
- Web page
  - displaying old content 291
  - list of visited 286
  - refreshing 279
  - saved 283
- Web preferences
  - ask before connecting 291
  - autofill forms 291
  - changing home page 287
  - clear History list 289
  - Connecting preferences 290
  - cookies 292
  - General preferences 287
  - image download 288
  - JavaScript download 288
  - old content 291
  - Privacy preferences 291
  - proxy server 291
  - size of History list 289
  - using 286
- Week (Date Book view) 99–100, 329, 396
- WEP encryption
  - adding 362
  - description 362
  - key index 364
  - types 363
- Wi-Fi
  - access point 358
  - adding connection 356
  - adding WEP encryption 362
  - ad-hoc connection 359
  - editing connection 356
  - international support 409
  - peer-to-peer connection 359
  - preferences 355–361
  - supported frequencies 409
  - viewing connection information 355
- Windows, system requirements 4
- Wireless
  - connections 273, 290
  - coverage indicator 268
  - service provider password 340
  - service provider username 340
  - supported frequencies 409
- World Clock
  - alarm 301
  - alarm preferences 302
  - display options 302
  - menus 302
  - opening 295
  - time zone 299
- Writing Area
  - activate and deactivate 22
  - preferences 22, 335
  - show penstroke 336
- Writing. *See* Entering data